

A Landowner's Guide to Wildlife Friendly Fences:



How to Build Fence with Wildlife in Mind

SECOND EDITION
REVISED AND UPDATED
2012



Montana Fish,
Wildlife & Parks



Acknowledgements

Acknowledgements

Since the original publication of *A Landowner's Guide to Wildlife Friendly Fences* in 2008, the idea of "building fence with wildlife in mind" has taken off like wildfire across the West. Other states have built on that original publication and produced their own fence manuals, and this author wrote a companion volume for Wyoming, *A Landowner's Guide to Fences and Wildlife*, published by The Wyoming Land Trust.

For this second edition, the material has been revised and updated, benefitting from the creative ideas and practical experience of landowners and resource professionals who have adopted a wildlife friendly approach to their operations. Joe Weigand, Montana Fish, Wildlife & Parks private land wildlife specialist, provided department funding and personal guidance for the project, as well as his extensive expertise from testing various fence solutions with landowners.

A special thanks to everyone who contributed their insights, research, photographs and manuscript reviews. Chris and Leo Barthelmess, Ralph Burchenal, John Kountz, Jeff Laszlo, Marina Smith, Wayne Ternes, Juanita Vero, the Anaconda Gun Club and the Rocky Mountain Elk Foundation partnered with Montana Fish, Wildlife & Parks to test fence designs in various livestock and wildlife situations and offered invaluable insights and suggestions. FWP biologist Jay Kolbe provided fence specifications, photos and other invaluable contributions to the project. Steve Primm and Seth Wilson of People and Carnivores, and FWP bear biologists Kim Annis, Tim Manley, and Mike Madel, contributed their expertise on fencing to exclude predators. Shawn Cleveland and Andrew Jakes shared their experiences and photos from the Transboundary Pronghorn Project. Montana Department of Transportation provided



Montana Fish, Wildlife & Parks



Christine Paige

Author
 Christine Paige
 Ravenworks Ecology
 Jackson, WY
 chrispaige@gmail.com

Editor/Publisher
 Joe Weigand
 Private Land Wildlife Specialist
 Montana Fish, Wildlife & Parks
 Helena, MT
 joweigand@mt.gov

Graphic Design
 Nancy Seiler
 Missoula, MT
 nancy@nancyseiler.com

Illustrations
 E.R. Jenne Illustration
 Missoula, MT
 edjenne@earthlink.net

Citation
 Paige, C. 2012. *A Landowner's Guide to Wildlife Friendly Fences*. Second Edition. Private Land Technical Assistance Program, Montana Fish, Wildlife & Parks, Helena, MT. 56 pp.

photos, specifications, and experiences with highway right-of-way fence.

Bryce Andrews conducted interviews and wrote many of the profiles detailing landowner and ranch manager experiences. Many other landowners, biologists, and resource professionals in Montana and throughout the U.S. also

contributed their expertise, references, and photographs, considerably adding to the breadth of innovative ideas.

My deep appreciation to Ed Jenne for his wonderful illustrations and to Nancy Seiler for her beautifully creative talent in layout and design. Any errors in this manual are mine alone.



Christine Page

| | |
|---|-----------|
| Wildlife and Fences | 4 |
| Problem Fences | 5 |
| Wildlife Friendly Fences | 8 |
| Getting Started | 8 |
| Fence and Crossing Placement | 9 |
| Friendly Designs | 10 |
| An Ideal Fence | 10 |
| Visibility | 11 |
| Sites with Low or Seasonal Livestock Use | 14 |
| Sites with High or Continuous Livestock Use | 20 |
| Openings, Crossings and Passes | 27 |
| Highway Right-of-Way Fence | 38 |
| Remedies for Existing Fences | 42 |
| Residential Fences | 45 |
| Fence Alternatives | 46 |
| If You Must Exclude | 47 |
| Deterring Large Predators | 51 |
| Getting Help | 54 |
| Sources | 55 |

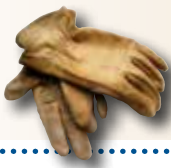

Why build wildlife friendly fences?

Fences are essential for controlling livestock and trespass, and countless miles of fence crisscross the West like strands of a spider's web. Fences define and separate ranches and farms, outline property boundaries, enclose pastures and rangelands, and prevent livestock from straying onto highways.

Yet those miles of fence can also create hazards and barriers for wildlife, from big game animals to birds. Fences can block or hinder daily wildlife movements, seasonal migrations, and access to forage and water. Wildlife may avoid areas with too many fences to negotiate. For example, pronghorn choose seasonal ranges with lower fence densities (Sheldon 2005). When animals collide with or become entangled in fences they can be injured or killed, and wildlife damage to fences can be costly and frustrating for landowners.

MANY WILDLIFE FRIENDLY
FENCE DESIGNS ARE EASY AND
LOW-COST, OR SAVE MONEY BY
REDUCING FUTURE FENCE REPAIR.

Not all fences create problems for wild animals. By tailoring fence design and placement, you can reduce wildlife injuries and decrease damage to your fence. Many of these methods are low-cost or can save money in the long-run by reducing the need for future fence repair.

This guide will help you construct and modify fences and crossings that are friendlier to wildlife while still meeting fencing needs. It will also help you with sources for technical assistance and possible cost-share opportunities.

Fence Law in Montana

Fence In or Fence Out?

Most of Montana is classified as open range, which means that by law landowners are responsible for “fencing out” neighboring livestock, and a livestock owner is not liable for trespass or damage if a property is not adequately fenced. This custom has deep roots in Montana’s history and ranching traditions. However Montana’s open range law applies only to cattle. Bison, sheep, and other livestock must be fenced in (Mont. Code Ann. § 81-4-201).

If the area you live is classified as “closed range,” however, the livestock owner is responsible for “fencing in” all livestock. Incorporated cities and towns are classified as closed range. Counties may also create “herd districts” in unincorporated rural areas that are classified as closed range. If you’re unsure if your area is open or closed range, contact the Montana Department of Livestock (MDOL; www.liv.mt.gov).

In practice, many livestock operators fence their property and pastures to better manage their livestock and range resources. Where their pastures adjoin federal lands, livestock owners are also responsible for preventing their livestock from illegally trespassing on those lands.

Along railroads, the railroad company must build and maintain fences to keep livestock from wandering onto the tracks. Similarly, the Montana Department of Transportation (MDT) can construct fences along highways to prevent livestock from wandering into the right-of-way.

Legal Fence

Montana Code defines a legal fence as one of several possible designs (Mont. Code Ann. § 81-4-101). Generally, a legal fence is one constructed well enough to keep out or contain livestock. While the code defines heights for a legal fence, it also stipulates that “all other fences made of barbed wire, which shall be as strong and as well calculated to protect enclosures” as the standards specified are also legal. All “rivers, hedges, mountain ridges and bluffs, or other barriers over or through which it is impossible for stock to pass” are also included as legal fence.

Posting Against Trespass

In Montana, notice against trespass on private land must be placed on a post, structure, or natural object, either by written notice or with at least 50 square inches of fluorescent orange paint. For metal fence posts, the entire post must be painted. Notice must be placed at each outer gate and normal point of access to the property, including both sides of a water body wherever it intersects an outer boundary line (Mont. Code Ann. § 45-6-201).

Other Regulations

Check your local covenants and county and city offices for specific fence regulations. If your property adjoins a state highway, contact MDT regarding options for modifying highway right-of-way fences for wildlife (www.mdt.mt.gov).



Christine Paige



Problem Fences

Deer, elk, moose, bighorn sheep, and pronghorn are all capable of jumping fences, but many common fence designs and situations can snare and injure these and other wildlife.

Wire strands can readily entangle legs, especially if wires are loose or spaced too closely together. Deer, elk, and other wildlife often bear scars from wire barbs. A torn ligament, strained leg, or infection can reduce an animal's chance of survival, and if animals can't pull free at all, they die slowly of trauma and dehydration.

Animals can be blocked by fences that are too high, impermeable, buried in deep snow, or on steep slopes. Young, pregnant, or winter-stressed animals may have a particularly difficult time clearing fences.



Cory Loecker

Some fences, especially woven wire fence, can be a complete barrier to fawns and calves even if adults can still jump over. Separated from their mothers and stranded from the herd, the youngsters often curl up and die of exposure and dehydration. Woven wire can snare and strangle medium-sized animals and livestock if they push their heads through the wire mesh, and may block animals such as bears and bobcats that are too large to slip through.

If woven wire is topped with one or more strands of barbed wire, the fence becomes a complete barrier, especially for fawns, calves, pronghorn and other animals that are incapable or



Colorado Parks and Wildlife

WINTER-STRESSED, PREGNANT AND YOUNG ANIMALS MAY ESPECIALLY HAVE TROUBLE CLEARING FENCES. AN INJURY OR INFECTION FROM TANGLING WITH FENCES CAN REDUCE AN ANIMAL'S CHANCE OF SURVIVAL. IF ANIMALS CAN'T PULL FREE AT ALL, THEY DIE OF TRAUMA AND DEHYDRATION.

unwilling to jump over such a fence. Animals trying to leap a woven wire fence topped by barbed wire are even more likely to tangle a leg between the top barbed wire and the stiff woven wire.

In urban areas, fences topped with barbs or pointed spikes, such as decorative iron fences, can trap or impale leaping deer and other animals.

Large, low-flying birds, too, may collide with fences and break wings, impale themselves on barbs, or tangle in wires. Ducks, geese, cranes, swans, grouse, hawks, and owls are especially vulnerable. Waterfowl fly into fences that run near or across waterways, and hawks and owls may careen into fences when swooping in on prey.



Mark Gocke



Sheila Lamb



Problem Fences

Jack Jones



Jeremy Roberts, Conservation Media



Tom Campbell



What kinds of fence cause problems for wildlife?

Fences that:

- are too high to jump;
- are too low to crawl under;
- have loose or broken wires;
- have wires spaced too closely together;
- can impale or snag a leaping animal;
- are difficult for running animals or birds to see;
- create a complete barrier;
- create a 3-dimensional obstacle.

Doug Wood



Above: This peregrine falcon died when it collided with a fence while diving on killdeer. Many birds are vulnerable to fence collisions.



Chris Mayne

Above: After crossing a highway, a black bear desperately searches for a way through a woven wire fence, finally climbing a power pole to leap over.



Tom Koenig, Colorado Parks and Wildlife



The Bottom Line: Hard Numbers

Recently, researchers at Utah State University completed a study of wildlife mortality along more than 600 miles of fences in the rangelands of northeastern Utah and northwestern Colorado (Harrington 2005, Harrington and Conover 2006). By repeatedly driving and walking fencelines over two seasons, they tallied the number of mule deer, pronghorn, and elk carcasses they found caught in fences and lying next to fences. They also studied which fence types caused the most problems.



The Jackson Hole Guide

Here are their key findings:

Snared and Entangled

- On average, one ungulate per year was found tangled for every 2.5 miles of fence.
- Most animals (69% of juveniles and 77% of adults) died by getting caught in the top two wires while trying to jump a fence.
- Juveniles are 8 times more likely to die in fences than adults.
- Mortalities peaked during August, when fawns were weaned.
- Woven wire fence topped with a single strand of barbed wire was the most lethal fence type, as it easily snared and tangled legs between the barbed wire and rigid woven wire.
- 70% of all mortalities were on fences higher than 40".



Steve Primm

TIP:

IF YOU ATTEMPT TO RESCUE A TANGLED AND STRUGGLING ANIMAL, AND YOU CAN SAFELY DO SO, COVER ITS HEAD WITH A CLOTH OR COAT TO HELP CALM IT.

Above: This badly tangled pronghorn was fortunately freed by the photographer, who was able to clip the wires.



Bryce Andrews

Elk, deer, and other ungulates often die if their legs tangle in wire fences. Woven wire topped with barbed wire was found to be the most lethal type of fence, especially for young wild ungulates.

Blocked and Stranded

- Where ungulates were found dead next to but not in fences, on average one ungulate per year died for every 1.2 miles of fence.
- 90% of these carcasses found near fences were fawns lying in a curled position – probably separated from their mothers when they could not cross.
- Most of these indirect mortalities were found next to woven wire fences.



Randy Gazda



Tim Stevens

Antlered animals can become fatally tangled in poly rope fence and loose barbed wire. Maintaining fence tension and using high-tensile wire for electric fences can help prevent such losses.



Wildlife Friendly Fences

Getting Started

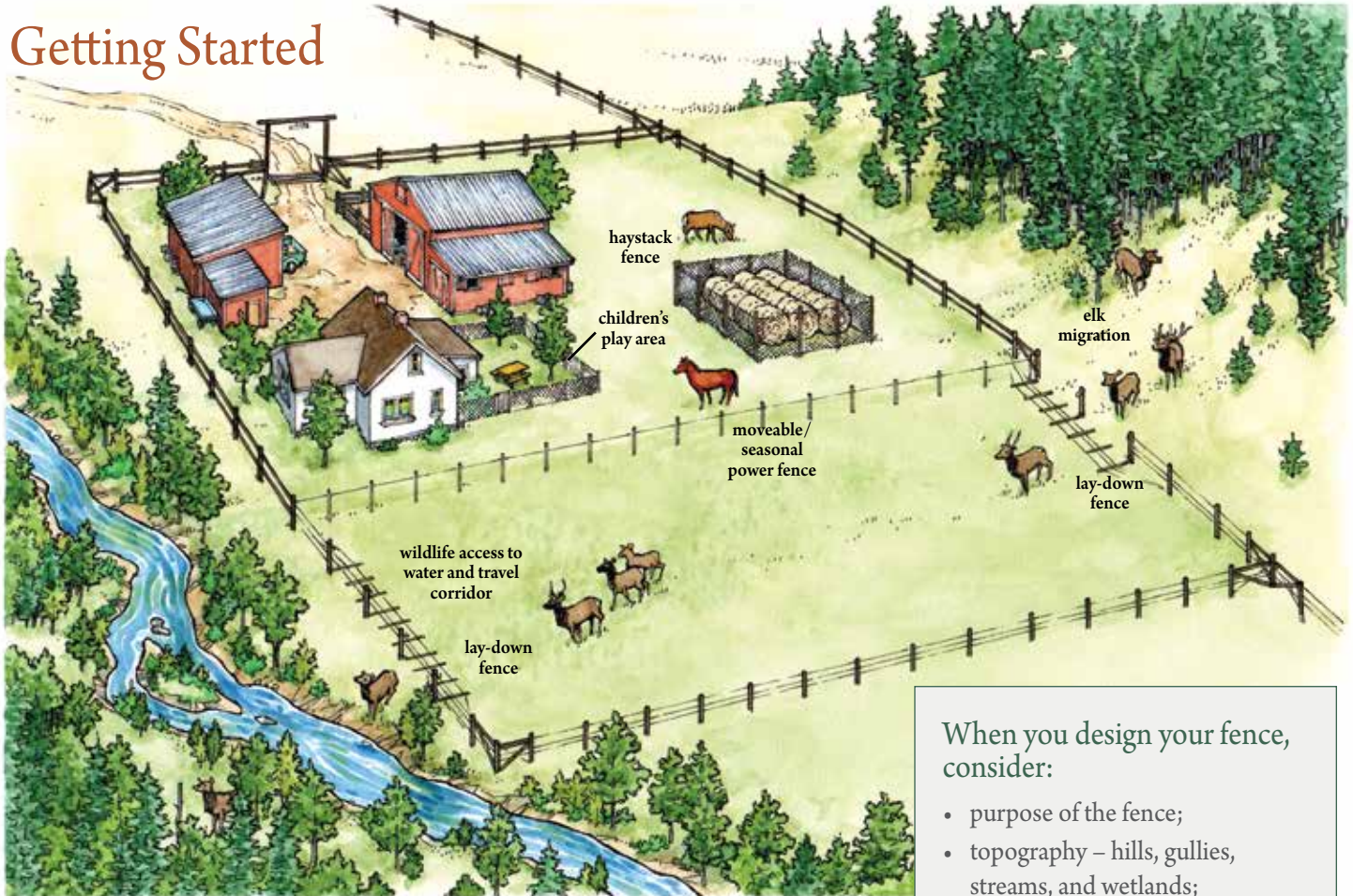

The best situation for wildlife is open habitat with no fences at all. Wherever possible, remove obsolete fences that are no longer needed.

Where you need to fence, less fence is better. Established fences can be modified to allow easier passage, and new fence can be designed with wildlife in mind.

To get started, consider your needs and create a plan. You can tailor any of the designs in this guide to your specific needs.

First consider these questions:

- 1. What is the purpose of the fence?**
Do you need to mark a boundary? Deter trespass? Enclose or exclude livestock? If your fence is for livestock, what kind, in what seasons, and for how long?
Your purpose should determine your fence design and placement.
- 2. What is the topography?**
Are you fencing on hills, in rocky country where posts cannot be driven, or near or across streams or wetlands?
Design your fence to avoid creating traps for wildlife.
- 3. Which wildlife species are in your area?**
Build fence or crossings that both young and adult animals can negotiate.

When you design your fence, consider:

- purpose of the fence;
- topography – hills, gullies, streams, and wetlands;
- species of wildlife present;
- daily or seasonal wildlife movements in the area;
- presence of water, food, and cover for wildlife;
- presence of young animals.

- 4. What are the daily or seasonal wildlife movements in the area?**
Do animals calve or nest nearby? Does wildlife migrate through to winter or breeding areas?
Allow movement and access through natural corridors and habitats.

MOST FENCES CAN BE DESIGNED OR MODIFIED TO ALLOW EASIER AND SAFER PASSAGE FOR WILDLIFE.



Fence and Crossing Placement

Placement of fences is just as important as the type of fence used.

Fences need not restrict wildlife movement everywhere on your property. Wherever possible, design your fence to provide wildlife free travel to important habitats and corridors, as well as access to water. Wetlands and riparian habitats are especially important for all wildlife.

Watch for daily and seasonal wildlife movement patterns and look for trails. Use impenetrable, special-purpose fence only in specific areas where it is critical, such as calving or lambing pastures, haystacks, gardens, orchards, children's play areas, or kennels.

Design property boundary fence so wildlife can easily cross, or with gaps or lay-down sections for wildlife passage whenever and wherever livestock are not present.

Work with your land's topography. Swales, gullies, ridges, and stream corridors can funnel wildlife through an area. Keep these open to allow wildlife passage and avoid topography traps.

A fence of any height is more difficult to cross when placed across a steep slope or next to a deep ditch. As ground slope increases, the height



Christine Paige

Tailor your fences to specific needs and allow wildlife access to water, important habitats, and travel corridors.



Christine Paige

Good Fence Placement Tips

- Look for wildlife trails and watch for seasonal patterns.
- Provide wildlife access to riparian habitats, water holes, and other high quality habitats.
- Provide passage along swales, gullies, ridges, and stream corridors.
- Use the appropriate fence design for each activity.
- On slopes and in natural travel corridors, plan for wildlife crossings.

effective fence height to 48.6"; a slope of 30% increases effective height to 62"; and on a 50% slope animals encounter an obstacle 75" high. **Fences on steep slopes become nearly impossible for animals to jump over without injury.**

SLOPE INCREASES BARRIER

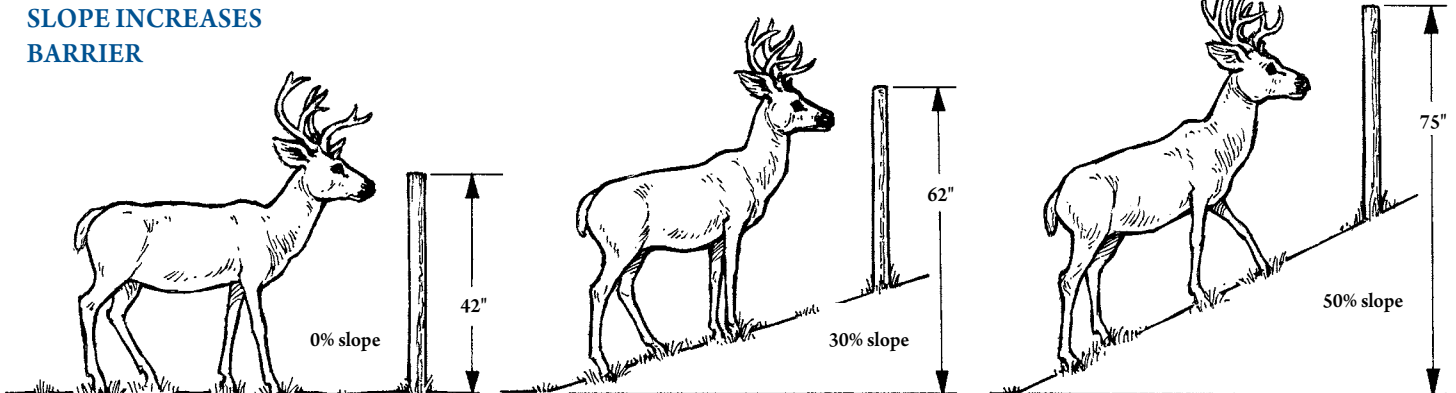

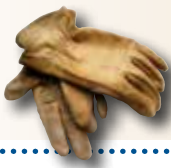

An Ideal Fence

A fence that is friendly to wildlife should:

- Allow animals to jump over and crawl under easily without injury;
- Be highly visible for both ungulates and birds.

You can combine or tailor many of the ideas presented in this guide to your specific situation.

The top wire or rail should be low enough for adult animals to jump over, preferably 40" or less, and no more than 42" high. The distance between the top two wires should be no less than 12" apart. Deer and elk easily tangle their back legs if the top wires are closer together.

The bottom wire or rail should be high enough for adult pronghorn and young wild ungulates to crawl under. The bottom wire should be a minimum of 16" from the ground and preferably at least 18." Take advantage of small dips, swales, and gullies to provide a slightly larger gap below the fence and allow animals to pass under easily. Many cattle ranchers have found that although a small calf may slip under the higher bottom wire, it can also easily slip back again to its mom and not be stranded on the wrong side of the fence.

IDEAL WILDLIFE FRIENDLY FENCE

ALTHOUGH CALVES MAY SLIP UNDER A HIGHER BOTTOM WIRE, THEY CAN ALSO SLIP BACK AGAIN TO MOM AND NOT BE STRANDED.

Increasing visibility using a top rail, high-visibility poly-wire, flagging, or other markers can help ungulates and birds better avoid or navigate fences. Using smooth wire – such as barbless twisted wire – for the top and bottom strands will prevent snagging and injuries.

Use electric tape or braid only for temporary applications. It should be removed or lowered to the ground when livestock are not present.

In some situations, fence stays can help maintain distance between strands,

prevent sagging, and reduce the chance of entanglement. However, wire stays are easily bent over, collapsing the fence and creating a three-dimensional hazard, and need to be regularly maintained. An alternative is a stiff plastic or composite stay or fiberglass post that flexes but maintains its shape.

In wildlife migration areas, drop-down fence, lay-down fence, or other crossings can be incorporated into fence sections for seasonal wildlife passage. **Good husbandry practices go hand-in-hand with wildlife friendlier fences. Livestock that have good forage and the security and companionship they want are much less likely to test or challenge fences.**

The Wildlife Friendly Fence: A Livestock/Wildlife Compromise

These standards will control cattle in most situations and allow for easier wildlife passage.

Fences should have top wires low enough for adult animals to jump, bottom wires high enough for wildlife to crawl under, and minimize the chance of tangling. We recommend:

- A top wire or rail preferably no more than 40" and a maximum of 42" above the ground;
- At least 12" between the top two wires;
- A bottom wire or rail at least 16" and preferably 18" above the ground;
- Smooth wire or rail for the top, smooth wire on bottom;
- Preferably, no vertical stays. If used, consider stiff plastic or composite stays, or regularly maintain wire stays that are easily bent;
- Posts at 16.5-foot intervals;
- Gates, drop-downs, or other passages where wildlife concentrate and cross.

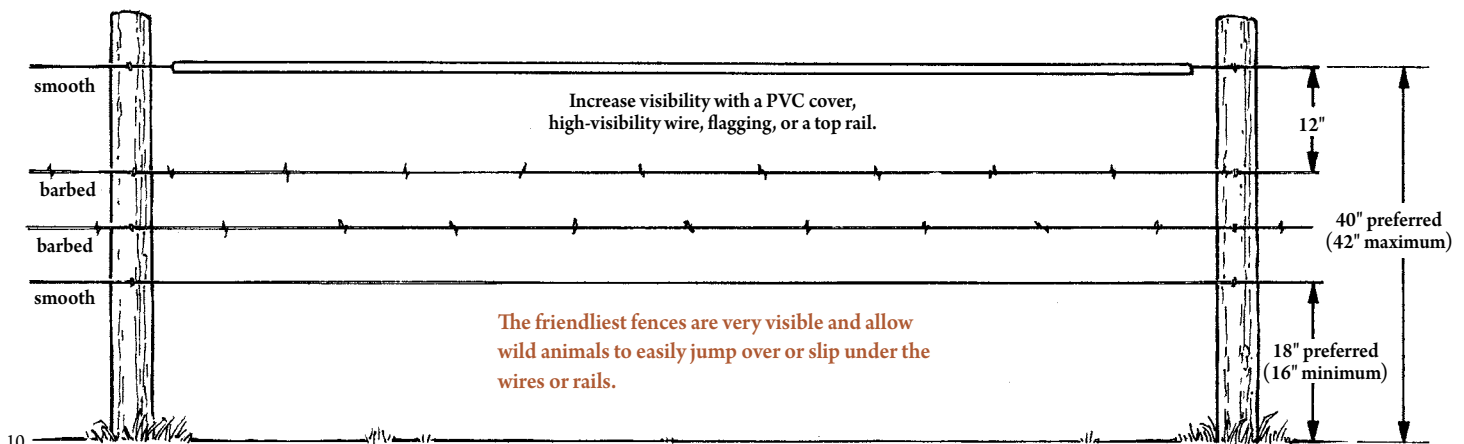



Christine Paige



Jay Kolbe

Visibility

Running animals and low-flying birds may not see a wire fence clearly against the landscape. Making a fence highly visible prevents collisions, and can help animals judge the height of a fence for jumping.

One solution is a top rail. A rounded rail is preferable as it sheds snow more easily – heavy snow buildup can sometimes deter elk and deer from crossing. For wire fences, an inexpensive modification is to slip sections of small-diameter PVC pipe over the top strand.

Smooth wire fences, especially high-tensile wire, may be essentially invisible to animals. Depending on the type of fence, these can be made more visible by adding PVC pipe, flagging, fence markers, or highly-visible polywire or polytape on the top strand. Twisted barbless cable is more visible than a single wire strand, and high-visibility wire is available in many

forms – tape, braid and polymer-coated wire – many of which can be electrified if needed. White wire is the most visible in summer, but black and white wire or tape makes the fence visibly obvious against both summer vegetation and snow.

High visibility helps wildlife negotiate fences. It is especially important in grasslands and near creeks and wetlands to protect low-flying birds, such as grouse, owls, and swans. PVC pipe, flagging, or black and white wire or tape all help wildlife see fences.



Montana Fish, Wildlife & Parks



Fence Flags for Grouse and Other Birds

Fence flags or markers dramatically increase visibility of wire fences for wildlife, especially birds, and help animals avoid and negotiate fences.

RESEARCH ON SAGE-GROUSE IN WYOMING, IDAHO, AND MONTANA HAS SHOWN THAT FENCE MARKERS CAN REDUCE FENCE COLLISIONS BY 70% TO MORE THAN 80%.

Research on sage-grouse and other prairie grouse has shown that fence collisions are common and widespread, especially near breeding areas.

Grouse fly fast and low into their mating areas (called “leks”) just before dawn and, in the dim light, are vulnerable to colliding with nearby fences.

However marking fence for visibility can dramatically reduce collisions by 70% to 83% (Christiansen 2009; Stevens et al. 2012b).



Mark Gockle



Jeremy Roberts, Conservation Media

Markers for Wire Fence

For barbed or woven wire fence:

- Cut several 12' strips of “undersill” or trim strips of white vinyl siding, available at home hardware centers.
- Cut strips to 3" pieces. Use tin snips for small projects or, with proper ventilation, use a 10" miter saw with a 200-tooth blade to cut up to 16 pieces at a time for larger projects.
- One 12' siding strip yields 48 pieces.
- For extra visibility, add reflective tape to both sides of the markers, which increases detection in low light. Or use both black and white markers for visibility against snow and vegetation.

- Snap pieces onto fence wires – they are held in place between barbs.

Wyoming Game and Fish has found that, for each 16' section of fence, a minimum of two pieces with reflective tape on the top wire is effective. Or, alternate four pieces of black and white markers on the top wire. Marking a lower or bottom wire will increase visibility for pronghorn and other wildlife.

For smooth wire fence:

- To keep the vinyl siding markers from sliding, crimp a ferrule, twist a small spring, or tighten a UV-resistant zip-tie (tie-wrap) onto the wire on each side of the marker. Although this adds time to installation, it keeps the markers in place. Crimping the marker itself causes the marker to wear and break.
- An alternative is to make flags from reflective tape that can adhere to the wire. (Note, however, that reflective tape will conduct power on a hot wire.)
- Some commercially made markers available online or in ranch supply outlets may work better on smooth wire.
- Place a minimum of two flags per 16' section of fence on the top wire; or up to four on the top wire and three on the middle or bottom wire.



Not every mile of fence needs to be marked for grouse. Marking is most important where there are high densities of birds: within 1.2 miles of a lek and in wintering areas. Also, sage-grouse are most vulnerable to collisions in open, flat, or rolling country, and in areas with many fences (>1.5 miles of fence per square mile; Stevens et al. 2012a, 2012b).

A relatively inexpensive and durable marking technique uses 3" flags cut from vinyl "undersill" or trim siding strips. The undersill siding has a lip that can be snapped onto barbed wire fence, with the barbs keeping the markers from sliding.

As an alternative, commercially produced fence markers can be purchased through a number of retail and mail order outlets.

For example, the Firefly Diverter (www.fireflytechproducts.com) has UV-visible reflective tape. Fly Safe (www.flysafellc.com) works on barbed wire. The See-A-Fence marker (www.knifesedgellc.com/seeafence.html) and Fence-flag (www.fenceflag.com) work on smooth wire fence.

While marking the top wire only is effective for grouse, adding markers to lower wires may also help pronghorn and other wildlife that slip under fences.

Durable and lightweight fence markers can be cut from strips of vinyl siding trim. The trim strip has a lip that easily snaps onto fence wires.

Tom Christiansen



Bruce Waage



Christine Paige

DURABLE MARKERS ON WIRE FENCE

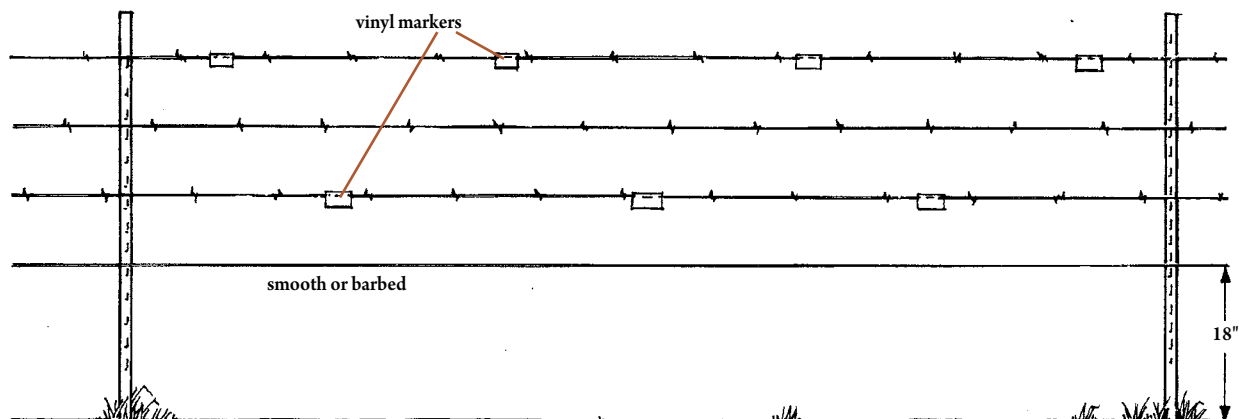



Sites with Low or Seasonal Livestock Use

Not all situations require a 5-strand barbed wire or woven wire fence. Many situations with low or seasonal livestock use can be fenced with a 3-strand smooth wire fence, various types of post and rail fences, or moveable electric fence. Seasonal pastures, cross fences, and horse pastures lend themselves to designs that are much more permeable for wildlife.

3-Strand Smooth Wire Fence

Use 3 strands of smooth (barbless) wire. To increase visibility, use coated wire or barbless twisted cable – the latter can also be more durable than single strand smooth wire. (Note that high-tensile wire should only be used for electrified applications. High-tensile can also be difficult for animals to see, and horses can sometimes be cut by high-tensile wire.)



Christine Paige

Christine Paige

3-Strand Smooth Wire Fence

- Top wire 40" to 42" high.
- Center wire 28" to 30" above the ground; maintain 12" spacing with the top wire.
- Bottom wire 18" above the ground.
- Preferably, no vertical stays.
- Wood or steel posts at 16.5-foot intervals.
- To increase visibility, use coated wire or double twisted smooth wire.

In the center of bighorn sheep winter range, this smooth wire fence replaced old 4- and 5-strand barbed wire fence. The fence is 3-strand smooth wire with a 39" top wire and 16" bottom wire. Bighorn sheep now readily hop over and duck under the fences.

3-STRAND SMOOTH WIRE FENCE

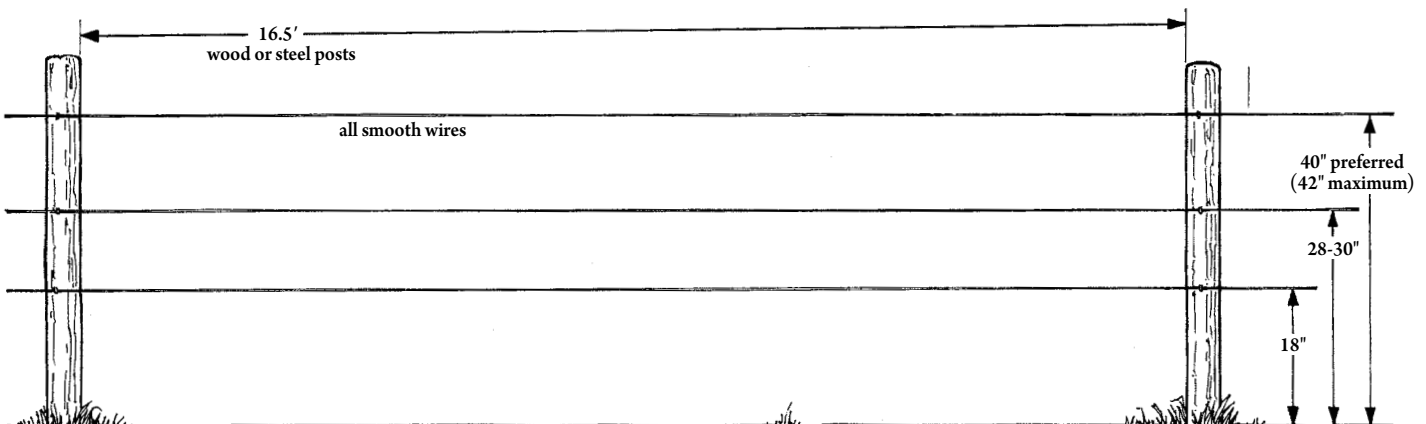

FENCE SOLUTIONS PUT TO THE TEST

Wildlife Friendly Klick Ranch

“When I drove in here yesterday, I parted mountain sheep like Moses did the Red Sea.” Dick Klick is talking about the road to his place at Castle Reef, 23 miles west of Augusta, Montana. Dick and his wife, Nancy, winter their horse herd here, and have made some adjustments to deal with the bighorn sheep, deer and elk that share their property.

On their winter place, the Klicks build mostly four-wire fence. The top two wires are barbed, while the bottom two are smooth. The top wire is hung 54" from the ground, and the wires are spaced 10" apart (24"-34"-44"-54" spacing). The fence hangs from six foot steel posts spaced on 17-foot centers.

Although the top wires are very high, the high clearance under the bottom wire allows wildlife to easily slip under and avoid accidental entanglement. When Dick notices an area that is used consistently by wildlife, he often pulls staples on sections of his bottom wire, raising it up to the level of second wire to make crossing even easier. Even modified this way, the fences effectively contain his horses.

In the summer, the Klicks graze their horses at the head of the Gibson Reservoir,



Christine Paige

on a 3,000-acre Forest Service allotment bordering the Bob Marshall Wilderness. Their place is remote, accessible by jet boat or horse depending on the season.

On the doorstep of the Bob Marshall, the Klick's allotment is used extensively by wildlife. In summer and early fall, the horses share the range with a large number of elk. Wherever possible, the Klicks have relied on natural barriers such as cliffs, steep slopes, and box canyons to contain their horses. To keep wildlife from damaging the three miles of fence they've built on the allotment, Dick and Nancy have

experimented extensively with design, location, and wire spacing.

On their summer place, the layout they favor is two barbed wires, the top wire at 48", the bottom wire 8" below that at 40", leaving ample clearance below. "It's 99% good for holding horses," says Dick. "The bull elk jump it, and everything else goes under easily, without even causing a ripple."

Dick stresses the importance of fence visibility in reducing wildlife conflicts. **He finds that fencing through dense trees often results in wildlife damage.** Because of this, he generally leaves a buffer zone between his fence and the tree line in meadows. When forced to go through trees, and if his Forest Service lease allows it, **Dick clears a pathway on either side of the fence to increase its visibility to wildlife.**

Replacing old fence with new, more wildlife friendly designs takes thought and effort, but Dick seems happy with the balance he's struck. The new fences are easier to maintain, and stand up better to wildlife crossings and snow drifts. "I'm getting older," Dick says. "I don't like to see a quarter-mile of fence strewn across the place by wildlife. We must work with animals up here."

– Bryce Andrews





Seasonal Electric Wire Fence

A flexible electric fence that allows passage for elk and other ungulates can still be effective for livestock, particularly horses trained to electric fence. It can be laid down seasonally to allow free wildlife passage. This fence is useful for keeping livestock out of sensitive habitats or for short-duration grazing where permanent fence isn't desired.

To work properly, this fence needs to flex as elk and other animals pass over it. Install as few rigid post supports as possible, and use the minimum recommended wire tension. Placing the energizer toward the middle of the fence will afford the greatest electrical efficiency.

Seasonal Electric Wire Fence

- Use pre-drilled 72" x 1" heavy fiberglass posts.
- Drive posts 24" into the ground at a 32-foot spacing (a t-post pounder can be used if ground is soft).
- Use treated wooden posts for bracing at ends and center.
- Place a top wire of conductive high-visibility tape, braided wire, or polymer-covered wire no higher than 42" height, electrically charged (medium-tensile 12-gauge plastic-coated wire is satisfactory).
- Place a second grounded strand of high-tensile wire at 30".
- Attach strands to fiberglass posts with wire clips that can be removed when fence is laid down.
- Use insulators for attaching hot top wire to wooden posts; grounded wire can be stapled or clipped directly to wooden posts.
- Use a solar electric energizer (size and placement depends on the run length of fence).
- Hard-wiring is an option when a power source is readily available.



Jay Kolbe

This 2-strand seasonal power fence can be used where livestock are trained to electric fence. Wooden posts brace the ends. The fiberglass posts can be laid down when the fence is not in use.



Jay Kolbe

FENCE SOLUTIONS PUT TO THE TEST *Collaboration in the Blackfoot Valley*

“Zero maintenance – it’s been amazing,” says Juanita Vero of her new stretch of electric fence. Juanita, the fifth-generation owner and manager of the E Bar L guest ranch in Montana’s Big Blackfoot Valley, has fixed her share of damaged fence. On the E Bar L, 80 head of horses share 4,000 acres of range with large numbers of deer and elk.

WHEN I ASKED MY 91-YEAR-OLD GRANDFATHER IF THE FENCE PROJECT WAS A SUCCESS, HE QUIPPED, “WE WOULDN’T DO IT IF IT WASN’T GONNA WORK.”
– JUANITA VERO

The vast majority of fences on the property are built with three- or four-barbed-wires hung from steel posts. Though these designs worked well on some parts of the ranch, they often failed when built across elk migration corridors. One particularly troublesome stretch ran for a half mile along the edge of an irrigated hay pasture. Elk crossed the fence on their daily circuit between the Blackfoot River and a stand of timber, frequently causing damage. The Veros were ready for an innovative approach to fencing, and they sought the help of Jay Kolbe, Montana Fish, Wildlife & Parks biologist, to help design the project.

Under an agreement to evaluate the design, and splitting costs and labor, FWP and the Veros built a two-wire electrified fence on 1" diameter fiberglass posts spaced



Juanita Vero

approximately 32' apart. The top wire, hung 48" off the ground, is a high-visibility, plastic-sheathed, conductive wire designed especially for horses. The lower ground wire, hung at 40", is standard 12.5 gauge high-tensile steel.

The new fence works well. “Elk go right through it,” Juanita says. “When nobody is putting pressure on them, even the big bulls go under with no problem.” It holds their herd of horses well, too, although Juanita remains uncertain whether the fence would adequately contain other types of livestock.

The Veros have experimented successfully on other parts of the ranch.

They use temporary electric fence to divide pastures into smaller units, allowing them to better control the way their herd grazes. Because this polywire fence is a single-strand design, it is highly permeable to wildlife.

Although most fence on the property remains barbed-wire, and the cost of replacing it with electric fence is high enough to be prohibitive, Juanita is upbeat about the potential for future innovation: “The best thing of all is that we have good agency people like Jay to work with, and a history of collaborative conservation in the Blackfoot Valley to build on.”

– Bryce Andrews



Moveable Electric Wire Fence

Moveable electric fence can be used for short-duration grazing, to keep livestock out of sensitive areas such as wetlands, or for other situations where livestock need to be temporarily controlled. This fence works well for livestock that have been previously trained to electric fence.

The design can be tailored to your situation, but a simple fence can be constructed using high-visibility tape or “turbo wire” and fiberglass posts or plastic-insulated steel posts. A moveable fence can use either a single hot wire (when there is sufficient moisture for an adequate ground) or two wires, the top one hot and the lower wire grounded. Moveable posts on the market include designs with hooked or pigtail tops for quickly stringing wire, and a tread-in base. These can be rapidly set up and moved as needed.

Moveable Electric Wire Fence

- Use 40" to 42" fiberglass or plastic-insulated steel posts, designed with hooks or loops for wire and tread-in spikes at the base.
- Place one to two strands of high-visibility tape or polymer-covered turbo wire. If using two wires, the top should be hot, the lower wire grounded. Top wire should be no higher than 42"; lower wire no lower than 18".
- Use a solar electric energizer (size and placement depends on the run length of fence).

Tips on Electric Fences

Most electric fence problems are caused by poor grounding. Follow the manufacturer's specifications for grounding the energizer and fence for your fence type and conditions. The number of ground rods needed may vary; a maximum reading of 0.2kv on a volt meter in dry conditions indicates an adequate ground. Wooden and steel fence posts require insulators for attaching hot wires; ground wires can be stapled or clipped on directly. Fiberglass and plastic line posts do not need insulators, but do require special clips for attaching wires. Check the fence regularly to be sure it is charged.



Seth Wilson



Christine Paig

A temporary electric fence can be used to keep livestock out of sensitive areas or to manage pasture use, and is easily negotiated by most wildlife.



Post and Rail Fence

A post and rail fence is highly visible to wildlife and can be constructed for situations with or without livestock. Rail fences can either use a top rail with wires below, or two to three rails total.

A 2-rail fence is preferable to a 3-rail fence for wildlife. Unless the fence is quite low, use rounded poles for the top rail rather than a square or split-rail to prevent too much snow build-up in winter, which can deter elk and deer. Also, unless the fence

is low enough to be easily jumped over and there is ample clearance underneath, boards or planks are not recommended, as these can create a visual barrier.



Christine Paige

Post and Rail Fence

- Use pressure-treated 6' to 8' posts, spaced 10' to 14' apart.
- Use pressure-treated poles for top rail, placed no more than 40" above the ground. A half-round rail will attach more snugly and require shorter bolts.
- Place smooth lower wires at 18" and 28" above the ground. Second wire should be at least 12" below top rail.
- OR use pressure-treated poles for lower rails, the bottom rail placed with at least 18" clearance from the ground.

POST AND RAIL FENCE

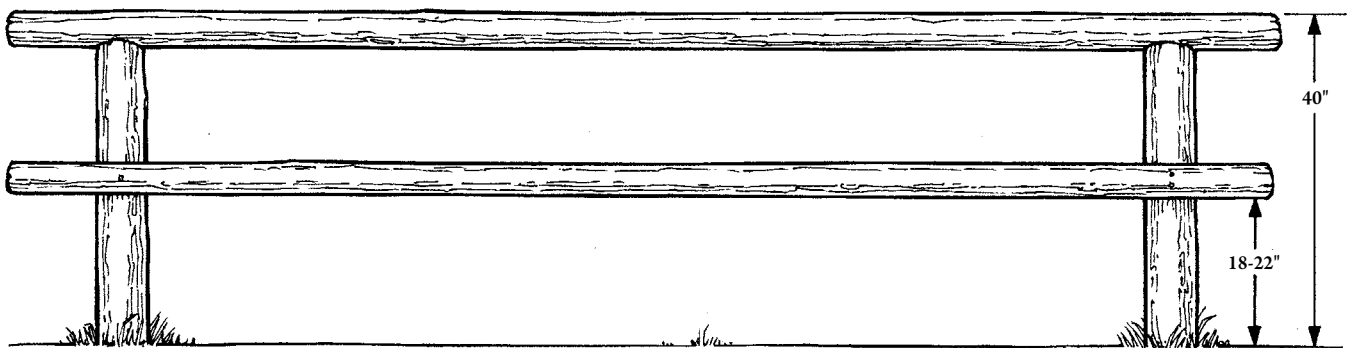

POST AND WIRE FENCE

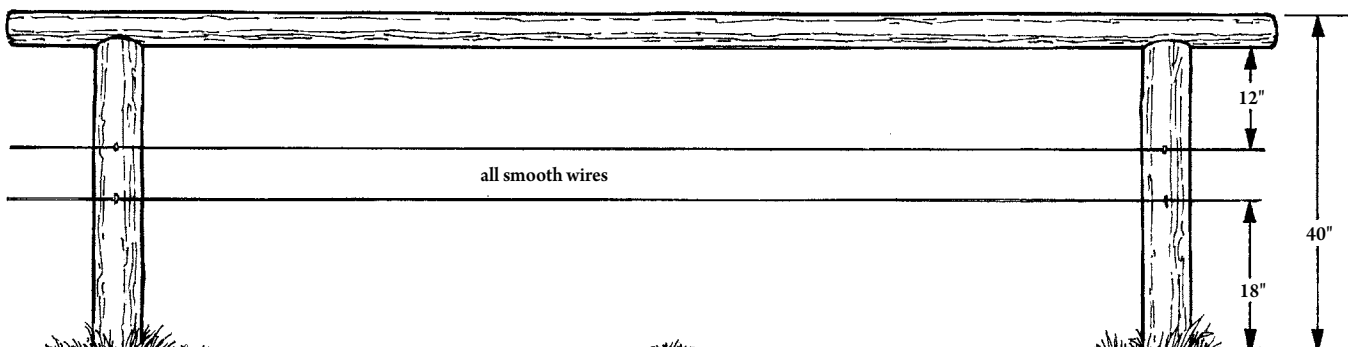



Sites with High or Continuous Livestock Use

Most livestock pastures do not require a 5- to 6-strand barbed wire fence. In many situations, a 3- or 4-strand barbed wire fence, a combination of smooth and barbed wire, or a high-tensile electric fence will work well for livestock control, particularly if the pasture quality inside the fence is as good or better as outside the fence.

Tips for Livestock Fences

Sheep, bison, and cows with calves may require a more impermeable fence for control. If you must use fences with woven wire or more than four wires follow these tips:

- Consider the placement of the fence perimeter carefully, and limit the extent of impermeable fence wherever possible.
- Avoid excluding wildlife from streamsides and water sources, or cutting off migration and travel corridors.
- Keep the fence height to a maximum of 40" to 42" and create periodic crawl-openings for fawns and calves by raising the bottom 18" from the ground, placed where animals typically travel.
- Avoid topping woven wire fences with barbed wire. In any situation, allow 12" between the top wire and the next wire below – whether barbed or woven wire.
- Create seasonal openings using lay-down fence sections or gates to open the fence during months when livestock are not present.



Christine Paige



Christine Paige

Create seasonal openings by leaving a gate open, lowering rails or wires, or using sections of lay-down fence during months when livestock are not present.



4-Strand Wire Fence for Cattle or Sheep

Woven wire fence, the most commonly-used type of fence on sheep range, is also the most problematic for wildlife. It can block wildlife passage, particularly for fawns, calves, pronghorn, and medium-sized animals unable to jump fences. When combined with barbed wire, it has the highest rate of entanglements for wildlife.

An alternative for sheep and cattle range is a 4-strand barbed wire fence that controls livestock but still allows for passage of pronghorn, deer, moose and elk.

For cattle, use a wire spacing of 18"-22"-28"-40"/42". The top wire should be at 40" to 42" or less. Allow 12" between the top two wires and 18" between the bottom wire and the ground. Use a smooth bottom wire.

Sheep require a low fence that would block most wildlife from crawling beneath the fence. However, a 4-strand fence for sheep can have a top wire no more than 32" high, which is low enough for most wildlife to jump. Allow at least 10" between the top two wires. A lower fence is easier for deer and elk to jump over, and the 10" spacing between top and second wire will usually be adequate. The bottom wire should be smooth wire and at least 10" above the ground.



A bottom smooth wire aids passage for pronghorn and other wildlife.

Combination Smooth and Barbed Wire Fence

In many situations, a combination of smooth wire and barbed wire can effectively contain livestock and allow for easier wildlife passage. Smooth wire can be used for the top and bottom wires and one to two barbed wire strands are used for the center strands. Barbless twisted cable wire or coated wire will increase visibility for wildlife. The top wire should be 40" to 42" high or lower, and the bottom wire at least 18" above the ground to provide wildlife clearance. Allow at least 12" between the top and second wires.

Combination Smooth and Barbed Wire

- Place top smooth wire at 40" to 42" maximum height – barbless twisted cable wire or coated wire is recommended.
- Allow at least 12" between top and second wires.
- Place bottom smooth wire at least 18" from the ground.
- Use barbed wire for center two wires.

Sheep and Cattle 4-Strand Barbed Wire Fence

(Adapted from Wyoming Game and Fish Dept., 2004)

Recommended Wire Heights Above the Ground

| | Cattle | Sheep | Sheep and Cattle |
|----------|-------------------|-----------------|------------------|
| Top wire | 40" to 42" barbed | 32" barbed | 38" barbed |
| 2nd wire | 28" barbed | 22" barbed | 26" barbed |
| 3rd wire | 22" barbed | 16" barbed | 18" barbed |
| 4th wire | 16" to 18" smooth | 10" min. smooth | 10" min. smooth |

4-STRAND FENCE WITH BOTTOM SMOOTH WIRE

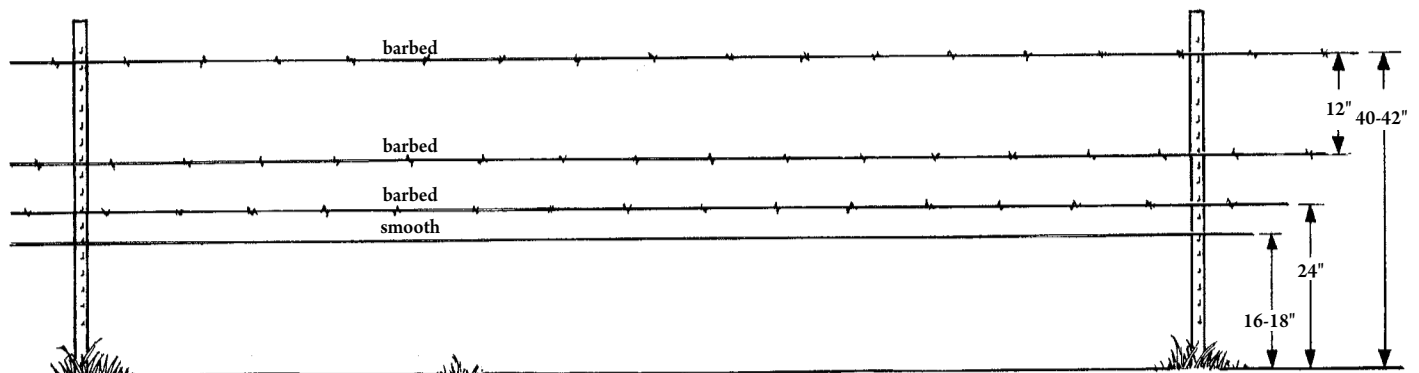

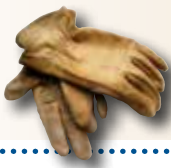

Wire Suspension Fence

Suspension fences have been used successfully on ranches for decades, and with modern materials they are proving to be durable, long-lasting, and low-maintenance. Wires are suspended across a long run between anchor posts, with fence stays placed at regular intervals to keep the wires from tangling. The fence is flexible and resilient when struck by large animals, allowing elk, deer, and moose to pass over easily, yet immediately returns to shape and effectively contains livestock.

A wildlife friendly suspension fence uses no more than four wire strands. Anchor posts are spaced at least 50' apart, up to a maximum of 100' apart, or much closer in uneven terrain. Adequate bracing is essential to maintain wire tension. Posts may be treated wood, metal, or one of the commercially available bracing systems (for an example, see Southwest Fence Systems braces at www.swfence.com).

To maintain wire spacing, lightweight wood, fiberglass, or composite stays are evenly spaced between the posts. Be sure stays hang free of the ground and won't catch on vegetation and twist the fence as animals pass over. The stays also reduce tangling and improve visibility for wildlife and livestock. Twisted wire stays are not recommended, as they are easily bent by wildlife passing over the fence,



Jeff Laszlo

This suspension fence has a top smooth wire and the stays are unanchored poles, allowing the fence to flex as wildlife passes over or under. Fiberglass or composite stays can also be used.

increasing fence maintenance and the risk of entanglement.

Place the top wire no higher than 40" to 42", the bottom wire at 18", and maintain 12" between the top two wires. A variety of barbed and smooth wire combinations can be used, depending on the situation. For example, use a bottom smooth wire where pronghorn or young deer, elk, or moose are present. A top smooth wire will aid passage for adult deer, elk, or moose. Use smooth wire for both bottom and top wires in areas with both pronghorn and elk, or both adult and young animals.

Suspension fence has the advantages of using far fewer posts than conventional fence – a savings in materials and labor, and a benefit where posts are difficult to drive. It also reduces or nearly eliminates long-term maintenance.

Wire Suspension Fence

- Place anchor posts 50' to 100' apart; closer in uneven terrain.
- Use sufficient bracing to maintain wire tension.
- Use a maximum of 4 wires: maximum 40" to 42" top wire, minimum 18" bottom wire, and 12" between the top two wires.
- Evenly space lightweight fence stays (wood, fiberglass, or composite) between the anchor posts. Easily bent wire stays are not recommended.
- Use smooth wire on top and bottom to ease wildlife passage.
- Suspension fence should be periodically checked for twisting, especially during peak migration/movement periods.

WIRE SUSPENSION FENCE

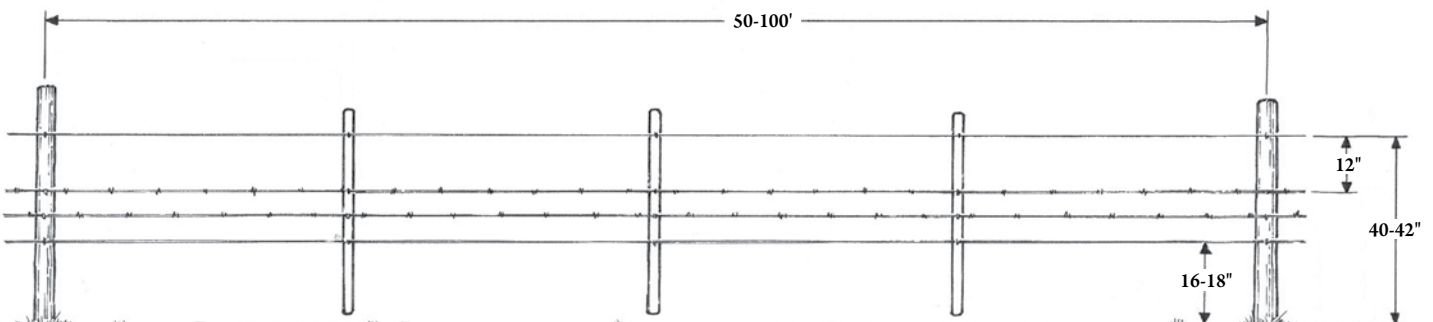

FENCE SOLUTIONS PUT TO THE TEST

Better Grazing, Thriving Streams and More Wildlife on the Granger Ranches

Jeff Laszlo is the fourth generation to operate the Granger Ranches, his family's traditional cattle ranch in Montana's Madison Valley. Spanning 13,000 acres between the soaring Madison Range and trout-laden Madison River, the ranch is a significant corridor for wildlife that move daily and seasonally through the valley, north and south, east and west.

In Jeff's grandfather's day, the family operated under the best understanding of husbandry of the time, draining wetlands, diverting streams, and creating a system of ditches to irrigate pastures. Today Jeff has taken a different approach to managing the ranch resources.

"We were looking for new ways to do business," he explains. In 2005, Jeff and his family undertook a long-term wetland and stream restoration project across the ranch. With technical expertise and financial help from a wide variety of non-profit, state and federal agency partners, Jeff has restored nearly 700 acres of river-bottom wetlands and 10 miles of spring-fed stream channels. The spring creeks once again hold trout, and in less than five years the birds have flourished from only 10 species to more than 100.

As part of the project, Jeff installed wildlife friendly suspension fence to keep his cattle out of the rejuvenating wetlands and streams while allowing wildlife to move through. FWP biologist at the time, Craig

On the Granger Ranches, extensive restoration of spring creeks and wetlands plus broad use of wildlife friendly fences have not only improved grazing and increased habitat for wildlife, but reduced fence maintenance.



"We were looking for a new way to do business," says Jeff Laszlo, 4th-generation owner of the Granger Ranches, seen here with his niece Caitlyn.

Jourdonnais offered help with the Granger Ranches' fence projects. "Working together leads to a lot of interesting possibilities," says Jeff. He liked the design so much he has installed wildlife friendly fence throughout the ranch, wherever old fences need replacement.

Jeff uses a 4-wire suspension fence, with his top wire no higher than 40" and bottom wire at 18" off the ground, the middle wires evenly spaced. Treated wood anchor posts are driven 50' apart and 3 wooden stays keep the wires spaced and taut. The fence then flexes and rebounds as elk, deer, or pronghorn pass over or under it.

On the uplands, where they have a lot of pronghorn, Jeff uses a smooth bottom wire to make passage under the fence easier. On the river bottom, they have more moose, so he reverses the design and uses a smooth top wire with three lower barbed wires.

"It's a better way to fence than standard 5-wire barbed," he explains. "First, we like

wildlife and have a lot on the ranch, and second, the suspension fence requires a lot less maintenance."

In addition to the permanent suspension fences, Jeff (in partnership with the Madison River Foundation) uses seasonal single poly-wire electric fence to intensively manage his grazing, especially in the river bottom where annual freezing and overflows make permanent fencing impossible to maintain. The seasonal fence allows Jeff to rotate pastures, control exactly where his cattle graze, and closely manage his grass.

"It produces better calves and leaves the land in better condition," Jeff explains. "It's important to me financially, but also important to me to leave better habitat. People value owning property with great wildlife values."

The intensive grazing management, he continues, "is especially important in a year like this with dry conditions and short grass. It's important to use the grass efficiently and not overuse it, which would potentially create costly issues – such as weeds and ground left less productive for future years."

"The typical ranch can't do this type of thing without partnerships, and that requires developing trust," Jeff adds. "I was willing to try a few things and learned there's a lot of common ground. We really appreciate the support that FWP has given the ranch. It has resulted in benefits for us as a ranch and for FWP's management of wildlife resources. It really makes sense for agricultural producers to use wildlife friendly fences, as they are less costly, allow for flexibility, and seem to last longer."



3-Wire High-Tensile Electric Fence

Researchers in Wyoming found that a flexible 3-wire high-tensile fence (with a hot – ground – hot configuration) is not only effective for containing cattle and bison, but also allows elk, mule deer and pronghorn to traverse the fence. They found that wild ungulates usually were not deterred by electric fences even with charges ranging from 0.5 and 4.5 joules, perhaps because of the insulating properties of their hair. Although wild ungulates were occasionally shocked when they nosed or bit a wire, or touched hot and grounded wires together, most animals readily negotiated the fences (Karhu and Anderson 2003, 2006).

Further, the researchers determined that 3-wire fences effectively contained bulls separated from cows coming into estrus, and calves from cows in the fall. Also, they found that a 3-wire fence was just as effective for containing bison as a 4-wire fence. A 2-wire fence can be used for areas without weaning calves but, curiously, pronghorn showed a high aversion to 2-wire fences, perhaps because of the novel height and their general reluctance to jump fences rather than crawl under (Karhu and Anderson 2003, 2006).

High-tensile fences require proper construction techniques, including



Rory Karhu

adequate braces, proper tensioning, care not to kink or break wire, and proper attachments and insulators for line posts and braces. The flexibility of the fence is key to allowing wildlife to pass over and through the fence. Fiberglass posts are used for all line posts, and wooden posts are used only for braces, direction changes, and gates.

High-tensile fences need minimal maintenance, provide great strength, can be easily electrified, and will outlast most other fences. For technical details, see the Natural Resources Conservation Service (NRCS) specifications for permanent power fence (NRCS 2006a).

A 3-wire high-tensile electric fence is effective even for separating bulls from cows in estrus, and for containing bison. Using high-tensile wire at the proper tension is key to prevent wildlife damage.

Note that smooth high-tensile wire can be difficult for animals to see. Adding markers or survey flagging to the top wire can help. Commercial examples that work on smooth wire include the See-A-Fence flag (www.knifedgellc.com/seeafence.html) and Fence-flag (www.fenceflag.com).

Keeping the fence powered prevents wildlife from leaning into it. If power is off, consider laying the fence flat to the ground if it will not create an entanglement hazard.

3-WIRE HIGH-TENSILE ELECTRIC FENCE

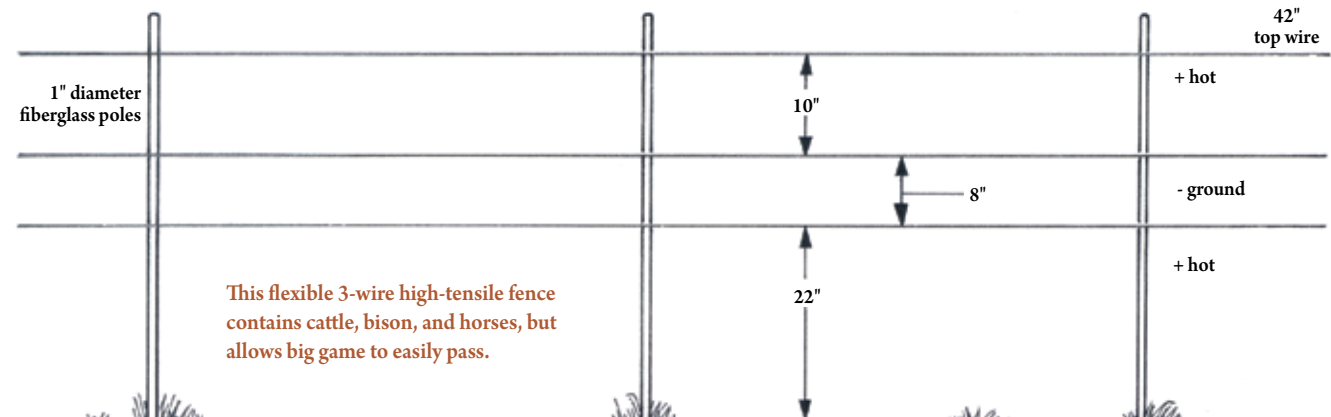



Rory Karhu

3-Wire High-Tensile Electric Fence

Maintaining fence flexibility is key to allowing wildlife to traverse the fence.

- Use fiberglass line posts no greater than 1" in diameter.
- Brace fence with wood posts at least 5" in diameter; brace all corners, gates, and direction changes greater than 15 degrees. Appropriate insulators are needed with wooden posts.
- Space line posts 45' to 60' apart and do not use stays. Fence stays make it harder for wildlife to pass between the wires, and may cause the fence to flip.
- Smooth, 12.5-gauge, Class III galvanized wire with a tensile strength of 170,000 PSI and breaking strength of 1,308 lbs. is adequate.
- Increase visibility by using flagging, fence markers, or high-tensile wire coated for visibility.
- Top wire is hot; second wire is grounded; bottom wire is hot.
- Space wires at 22"-30"-40"/42" from the ground. The top wire should be no higher than 42", with 10" between the top two wires. The 10" spacing is necessary for cattle to contact both hot and ground wires, but poses little hazard for wildlife due to the fence's flexibility and lack of barbs. A bottom wire at 22" allows both young and adult wild animals to pass under easily.
- Connect wires to posts with metal clips or fasteners designed for electric fences; use porcelain insulators on wooden braces.
- Tighten wires to 150 lbs. tension. If too tight, the wires are more likely to break. Although high-tensile wire has a high breaking point, it is also more brittle, and breaks easily if tightly bent or kinked.
- Place solar energizer according to manufacturer recommendations.
- Ground fence properly according to the energizer instructions, and add extra ground rods as needed. Locate rods at fence ends and intermittently in between.
- Ground rods are relatively cheap, and extra rods will ensure the fence will be effective.
- When livestock aren't present, either drop the wires flat to the ground or keep the fence electrified to prevent wildlife damage. (Keeping the fence powered can also prevent the battery from freezing and prolong battery life.)
- Securely attach electric fence warning signs intermittently along the fence and at gates and crossing points.

FENCE SOLUTIONS PUT TO THE TEST

Power Fences on the Sun Ranch

Sun Ranch manager James Stuart and his crew keep pretty busy. The 18,000 deeded acres of the ranch, situated in the foothills of the Madison Range in southwest Montana, provide critical fall, winter, and spring habitat for thousands of elk, and year-round range for deer and pronghorn. All this wildlife traffic, combined with a summer grazing operation that brings on nearly 2,000 head of cattle, puts a lot of pressure on the fences.

Over the past decade, the Sun Ranch management has tried out innovative fence designs to improve wildlife passage without sacrificing the ability to hold cattle. To make room for experimentation, ranch staff has torn out more than 30 miles of problematic barbed wire fence over the course of the last decade, often with the help of volunteers from conservation groups like the Rocky Mountain Elk Foundation and Greater Yellowstone Coalition.

One of the simplest and most effective ways of reducing wildlife conflicts, James found, was using temporary fence wherever possible. His preferred design is a single strand of polywire – a woven mix of plastic strands and conductive wire about the diameter of baling twine – hung 36" high from fiberglass posts on 50-foot centers. Using a specially equipped wire buggy, two ranch hands can build this fence at a rate of half a mile per



Bryce Andrews

Temporary single-strand electric poly-wire fence allows for easy manipulation of grazing patterns and highly permeable wildlife passage, while reducing fence maintenance.

hour, and pick it up again at a rate of two miles per hour. The ranch owns about 8 miles worth of posts, polywire, and solar-powered energizers, which they use extensively through the summer grazing season.

James stresses that the electrified polywire is a psychological barrier rather than a physical one, and that it helps to train cattle to respect it in a controlled environment. To do so, the crew builds a short stretch of power fence in a corner of their shipping pens, and expose new cattle to it as they arrive on the ranch. “One good shock,” James says, “and they get the idea.”

As a single-strand fence, the polywire is easy for wildlife to negotiate. Although elk and deer can damage it, especially if they come through in the night, James believes that temporary fence has been an extremely effective tool for improving wildlife passage, manipulating livestock grazing patterns, and reducing time spent repairing fence in the spring.

Where the crew built new permanent fences, two designs emerged as especially effective. One is a three-wire let-down electric fence built with wood posts and pin-lock insulators. Following the grazing season, all three high-tensile wires are dropped to the ground, where they stay all winter. **The extra work of raising and lowering these fences twice a year, says James, is nothing compared to patching elk damage in traditional barbed wire fences.**

The other key design is a two-wire electric fence hung from one-inch diameter fiberglass posts on 50-foot centers. The top wire is hot, and hung 32" from the ground. The grounded bottom wire runs 12" below it. “Pronghorn go under easily, and everything else goes over. Because the fiberglass posts can flex, the fence tends to bend instead of break”, James says. **Although a two-wire fence may seem like an insubstantial barrier, James stresses that it contains cattle very well, and that he’ll be building more of it in the future.**

– Bryce Andrews





Openings, Crossings, and Passes

You can include crossings in any fence design to allow passage for wildlife, especially when livestock are not present. Short sections can be altered to wildlife friendly standards to help wildlife cross, or gaps, openings and jumps can be added.

Fence passes keep fawns and calves from being stranded, provide openings for other animals unable to jump fences, and help wildlife cross when snow hinders passage over or under fences.

Wildlife crossings are especially important when fawns and calves are small, from June 1 through the summer, and for seasonal wildlife movements and



Scott Nicolarsen

ranges. Such openings can considerably reduce wildlife damage to fences and decrease maintenance costs.

Elk and other wildlife readily travel through seasonal fence openings. Here a wildlife gate is installed on an elk trail.



Christine Paige



Bert Lindler



Christine Paige

Fence alterations can include:

- Lowering the top wire or rail to 42" or less.
- Increasing the distance between top and second wires to 12".
- Raising the bottom wire or rail to 16" minimum, and preferably 18" or more.
- Replacing the bottom and top wires with smooth wire.
- Increasing visibility with a top rail, PVC pipe, high-visibility tape, braid, or markers.

Wildlife openings and passes can include:

- Gates secured open.
- Dropped rails and wildlife jumps.
- Sections with adjustable wires or rails.
- Sections of seasonal lay-down fence.
- PVC modifications for big game and pronghorn passage.

Use your local topography and patterns of wildlife travel to help you determine the best placement for crossings. Look for signs of wildlife use and travel such as game trails, tufts of hair caught on fence wires, trails to water, or gullies and swales that act as wildlife corridors.



Friendly Designs

Adjustable Wire Fence

Adjusting the height of one or more wires is an easy and effective way to allow animals to cross during migration periods if livestock aren't present. Drop the top wire to the level of the second wire, either in sections or along an entire run of fence, to allow wildlife to jump over easily. Lowering the top wire to 25" or less allows elk and deer to hop over easily in almost all conditions. Raise the lowest wire in the same way to help wildlife crawl under. A simple staple lock allows wires to be rapidly adjusted from one level to another, and the wires can be adjusted by only one person.



Christine Paige

Existing fences can be readily modified by installing staple locks to create a drop wire so wire height can be adjusted when livestock are not present.

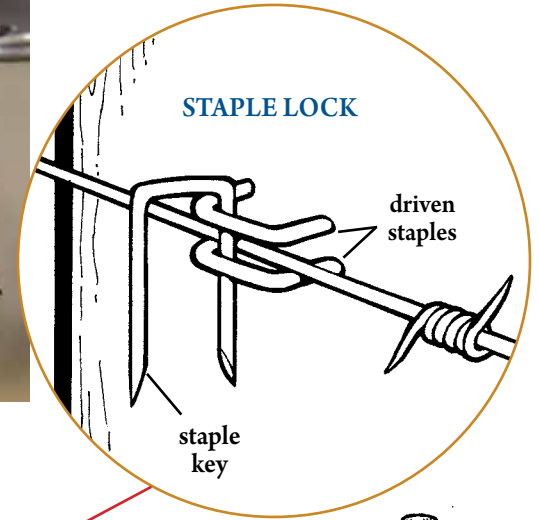

ADJUSTABLE FENCE FOR SEASONAL WILDLIFE PASSAGE

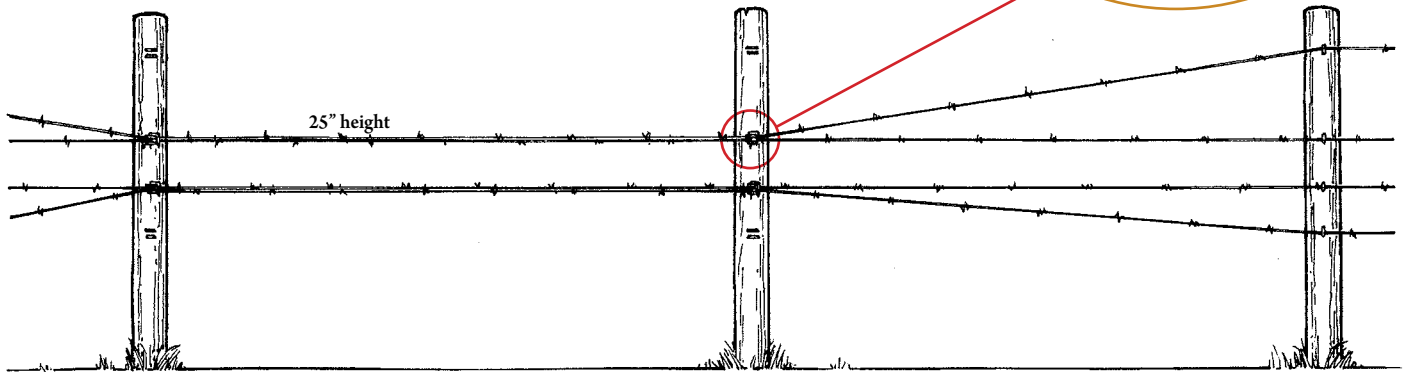

Staple lock for wooden posts

- Install two fence staples horizontally and less than an inch apart on each post at the level of both the top wire and the second wire.
- Slip the fence wire between the two staples.
- Secure it in place by hooking a third staple through the paired staples vertically, like a latch.



Marina Smith

FENCE SOLUTIONS PUT TO THE TEST

Searching for Solutions in the Madison Valley

Marina Smith knows as well as anyone how difficult it is to reconcile the needs of livestock and wildlife: she's been managing ranches at the south end of the Madison Valley for years. The properties in her charge sit astride an antelope migration corridor and provide crucial habitat for elk and deer.

Initially, these lands had woven wire and jackleg fence, and wildlife conflicts were commonplace. On one occasion, a black bear was stranded between a highway and a woven wire fence. Panicked, the bear tested the fence repeatedly, unable to pass through or over it.

Marina's challenge was to replace fences like this one with new designs more permeable to wildlife, but that would also reliably hold cattle for summer grazing.

Marina has torn out close to 30 miles of old fence. She has experimented with various fence designs – with mixed results. On the Elk Meadows property, she installed stretches of high-tensile electrified fence. These fences were highly effective for livestock containment when fully charged. However, many of the electric fences ran through areas with steep topography, rocky soil, and much wildlife traffic, making them susceptible to wildlife damage and difficult to maintain.

Marina also theorizes that wildlife have a hard time seeing the electric fences, as they can be built with thinner posts and fewer wires than traditional fences. Wildlife collisions frequently grounded out the fence, reducing its ability to hold cattle. (This

problem might be mitigated by using high-visibility wire, flagging, or other markers.) Sections of suspension fence, where posts were set at relatively long distances from each other and the wire spans were stiffened with wire or wood stays, fared even worse. In the process of crossing, elk would often cause the fence to twist. When inverted, the stays would catch on the ground, compromising the fence.

Marina found that the design that best balances her livestock production needs with her desire to enhance and protect wildlife habitat is a four-strand barbed-wire fence with a drop-down top wire. The top wire is hung at 42" inches and secured with a staple lock; the bottom wire is 18" from the ground. During fall and winter, in areas that serve as movement corridors for wildlife, Marina drops the top wire to 36". **Observing the way animals interact with the drop-wire fence has led Marina to conclude that these wire heights are critical for allowing wildlife passage.**

– Bryce Andrews

Ranch manager Marina Smith found that a seasonal drop-down top wire allows migrating elk to easily pass over the fence in fall and winter.



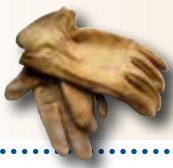

Pronghorn Underpass or "Goat Bar"

Although capable of jumping even high fences in extreme situations, pronghorn prefer to crawl under fences, and almost seem unaware of their ability to "high jump." They will often run for miles looking for fence openings or spots to crawl under a fence, and have been known to die of starvation in winter when blocked by a fence they see as impassable.

In Sheep Range:

Pronghorn have the greatest difficulty negotiating sheep fence, which either uses barbed wire strands lower than cattle and horse fence, or is typically made of woven wire. However, a pronghorn "underpass" can be created by raising the bottom strand in selected fence sections.

- For sheep, space wire strands at 10"–16"–22"–32" above the ground, the top three strands barbed wire, the bottom strand smooth wire.
- In selected sections, raise the bottom smooth wire on two posts to the height of the third wire, securing in place with a staple lock. The smooth wire can be dropped again if needed.

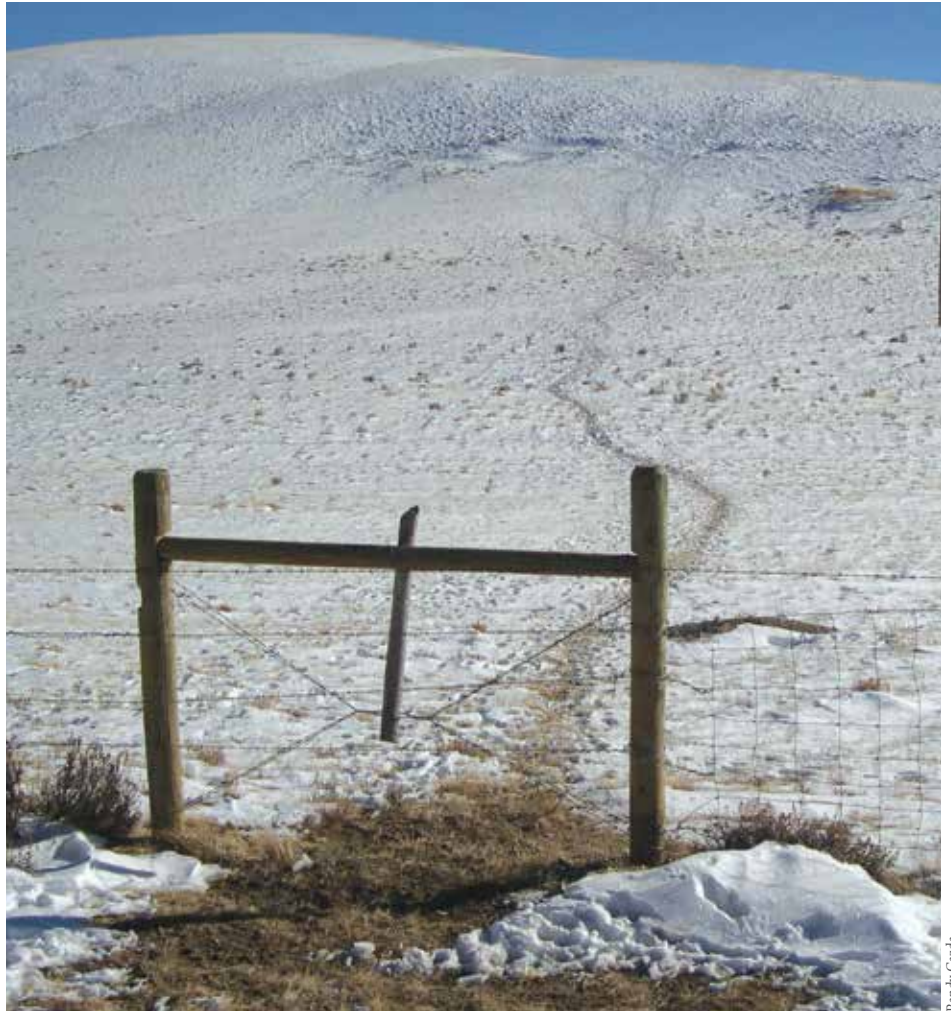

Randy Gazda

Pronghorn will readily use any section with a slightly raised bottom wire to crawl under a fence.

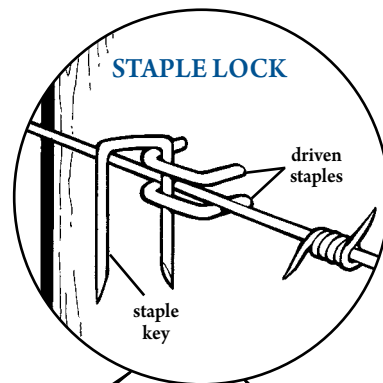

PRONGHORN UNDERPASS FENCE WITH RAISED WIRE

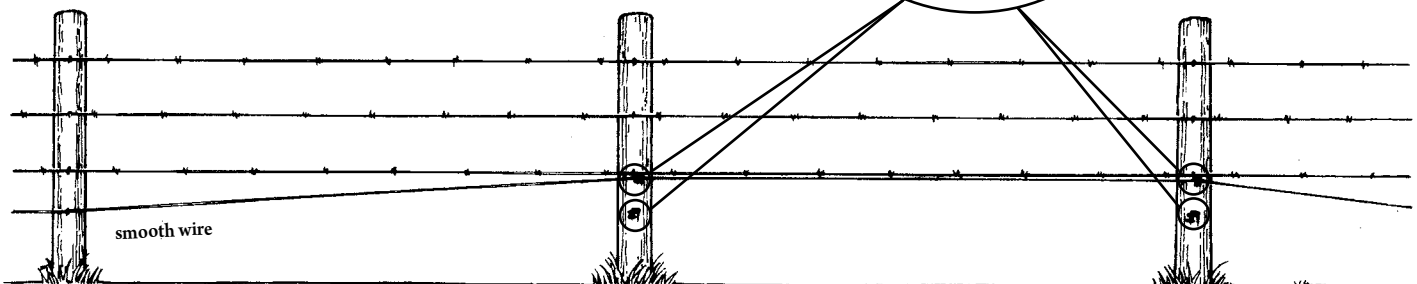



PRONGHORN UNDERPASS FENCE WITH GOAT BAR

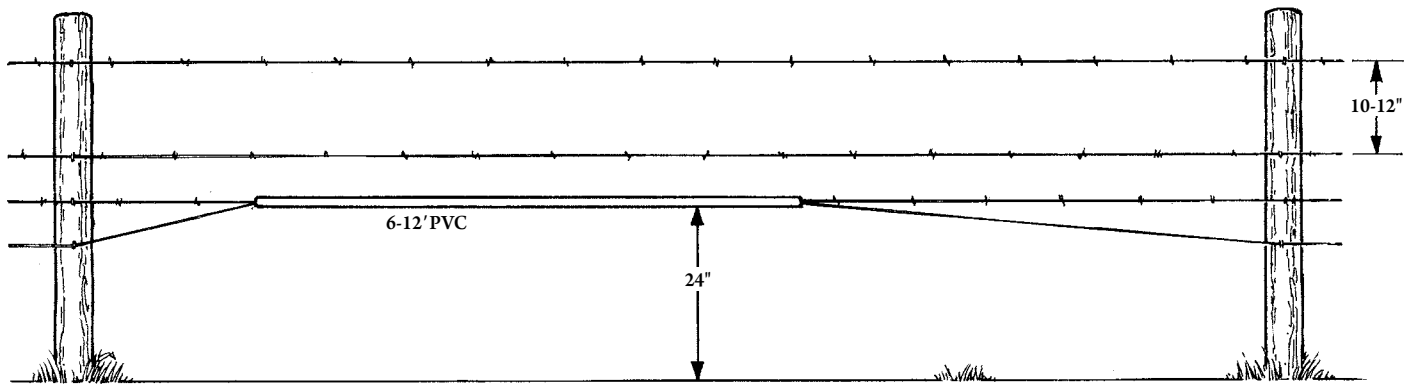

In Cattle and Horse Range:

Where cattle or horses share the range with pronghorn, a PVC underpass, or “goat bar,” can be created by simply gathering the bottom two wires in a PVC pipe to make a higher clearing for pronghorn of any age to crawl under. Despite the underpass, the fence remains effective for controlling horses and cattle. This design has been used extensively in pronghorn habitat.

- Space fence wires heights at 18"–24"–30"–40"; use smooth wire on the bottom.
- Cut several 6' to 12' lengths of PVC pipe.

- With a table saw, cut a ¼" slot the length of each PVC pipe. Note that a ¼" cut can be made by matching up two ⅛" wide blades and using a wood guide.
- Grip the bottom two fence wires together, and feed the PVC pipe onto the wire from one end of the pipe. If the pipe gets hung up on a barb at the fore-end, work the barb into the end of the pipe and continue. Once the pipe has been adequately started, grip the pipe near the fore-end and begin pulling down the length of the wire.

- Space these underpasses intermittently along the fence, and especially in fence corners where pronghorn may be directed by the run of fence.
- Add a PVC pipe threaded onto the top wire or top two wires to allow passage for deer and elk as well. The PVC greatly reduces the chance of snagging, injury and entanglement.
- Use two or three cable zip-ties to close up the gap on the PVC.

Pronghorn will seek places they can easily pass under a fence. Keep brush clear and take advantage of small gullies and swales to provide pronghorn passage.



FENCE SOLUTIONS PUT TO THE TEST

Pronghorn Know No Boundaries

The music of the wind is a constant companion on the sweep of native prairie that stretches across Montana, Alberta, and Saskatchewan. Once covered by glaciers, these northern plains are now blanketed by grasslands and sagebrush shrub-steppe, dimpled with pothole wetlands and gouged by craggy badlands. Late into the 19th century, massive herds of bison flowed across this landscape, and with them elk, pronghorn, mule deer, and their predators. Although the great bison herds are gone, pronghorn have held on in this northern limit of their range, claiming dual citizenship as they migrate across the international border between seasonal ranges.

Today the glacial soils of this wide-open country support grain farms and ranches, but the fences that divide and protect croplands and rangeland prove a constant challenge to pronghorn as they follow their ancient migration paths.

Pronghorn Pathways

In 2007, state and provincial wildlife agencies in Montana, Alberta, and Saskatchewan formed the Northern Sagebrush Steppe Initiative (NSSI). The goal was to help sustain the northern prairie's wildlife populations by sharing data and promoting collaborative research. In 2008, the NSSI and researchers at the University of Calgary launched the Transboundary Pronghorn Project with support from the Alberta Conservation Association, Saskatchewan



Shawn Cleveland

Ken Plourde, University of Montana wildlife biology student, lends a hand rolling up old woven wire that was replaced with pronghorn-friendly fence.

Ministry of Environment, U.S. Bureau of Land Management, and World Wildlife Fund. The project uses data from two recent studies of GIS-collared pronghorn in Alberta (72 individuals) and Montana/Saskatchewan (111 animals) to understand their seasonal movements and pathways across the entire region.

Maps of the collared animals' daily and seasonal movements clearly show where pronghorn are hindered by fences, sometimes spending several days attempting to find a way through or around. Because pronghorn are adapted to open grass ranges and sagebrush steppes, where the tallest objects are sagebrush, they are usually

reluctant to jump over fences. Despite an ability to jump, they prefer instead to crawl under and are often blocked by woven wire fence or barbed wire fence with wires low to the ground.

Cooperative Solutions

Removing obsolete fences or modifying existing fence can allow pronghorn to slip through without missing a beat. A collaboration among the University of Calgary researchers, the Montana Chapter of The Nature Conservancy (TNC), FWP, and area livestock growers is removing the barriers for pronghorn once again.

TNC has a long history of partnership and stewardship with private landowners in northeastern Montana. On the Conservancy's Matador Ranch, a 60,000-acre preserve in Phillips County, TNC runs a program of community grassbank leases. Under the program, local ranchers help manage the grassbank and pay discounted fees to graze their cattle on the Matador Ranch in exchange for wildlife conservation practices on their own operations, including wildlife friendly fencing. TNC also works with private landowners to develop conservation easements to sustain native grasslands and working lands.

TNC was awarded a grant to integrate the NSSI pronghorn research into on-the-ground conservation. Using the data to identify specific sites where pronghorn meet barriers, TNC works with private landowners to remove or modify fences.

Cattle, sheep, and pronghorn

On the Barthelmess Ranch, run by brothers Leo and Chris Barthelmess, the family has partnered with TNC, National Resources Conservation Service (NRCS), and FWP on several projects to sustain pronghorn migration. The family has a tradition of sustainable ranching – using best-management practices to provide for their livestock and protect the soil and water resources. They also highly value the wildlife on their ranch, from large game to birds.

“Why do this? There are three reasons,” says Leo. “One is that wildlife is important to our community and us. A second reason is we are seeing reduced maintenance on fences that are modified to allow for wildlife passage. And third, there are people and agencies that will invest resources to help us do this.”

One project removed one-half mile of woven wire fence and replaced it with a combination of smooth and barbed wire fence that meets wildlife friendly standards. The new fence uses a smooth wire on the bottom, a top wire no higher than 42”, and at least 12” between the top two wires. Although the family raises sheep in addition to cattle, they have eliminated all woven wire fence on their ranch. Yet the new fence design effectively contains their livestock, which do not pressure the fences due to good husbandry and plentiful forage.

“Recently, I spent a day maintaining an old fence line that had not yet had the wire spacing modified for wildlife migration” says Leo. As I came to areas that indicated substantial antelope migration – the bottom wire was broken or stretched far off line – I raised the bottom wire until it was 18 or more inches off the ground. I anticipate in the future that there will be little need for additional maintenance on these portions because of wildlife damage. In the future, I will monitor these fence adjustments and see if the antelope consistently use these crossing areas as opposed to making new ones.”

Leo concludes, “It is our best hope that these efforts will aid in the survival of wildlife migration routes and help us continue to ranch sustainably in the future.”



Samantha Howlett

A pronghorn doe slips easily under a fence modified so the bottom wire is at least 16” to 18” off the ground.

Telemetry research on collared pronghorn show distinctly where animals are hindered by fences along their migration, sometimes delaying them by several days.

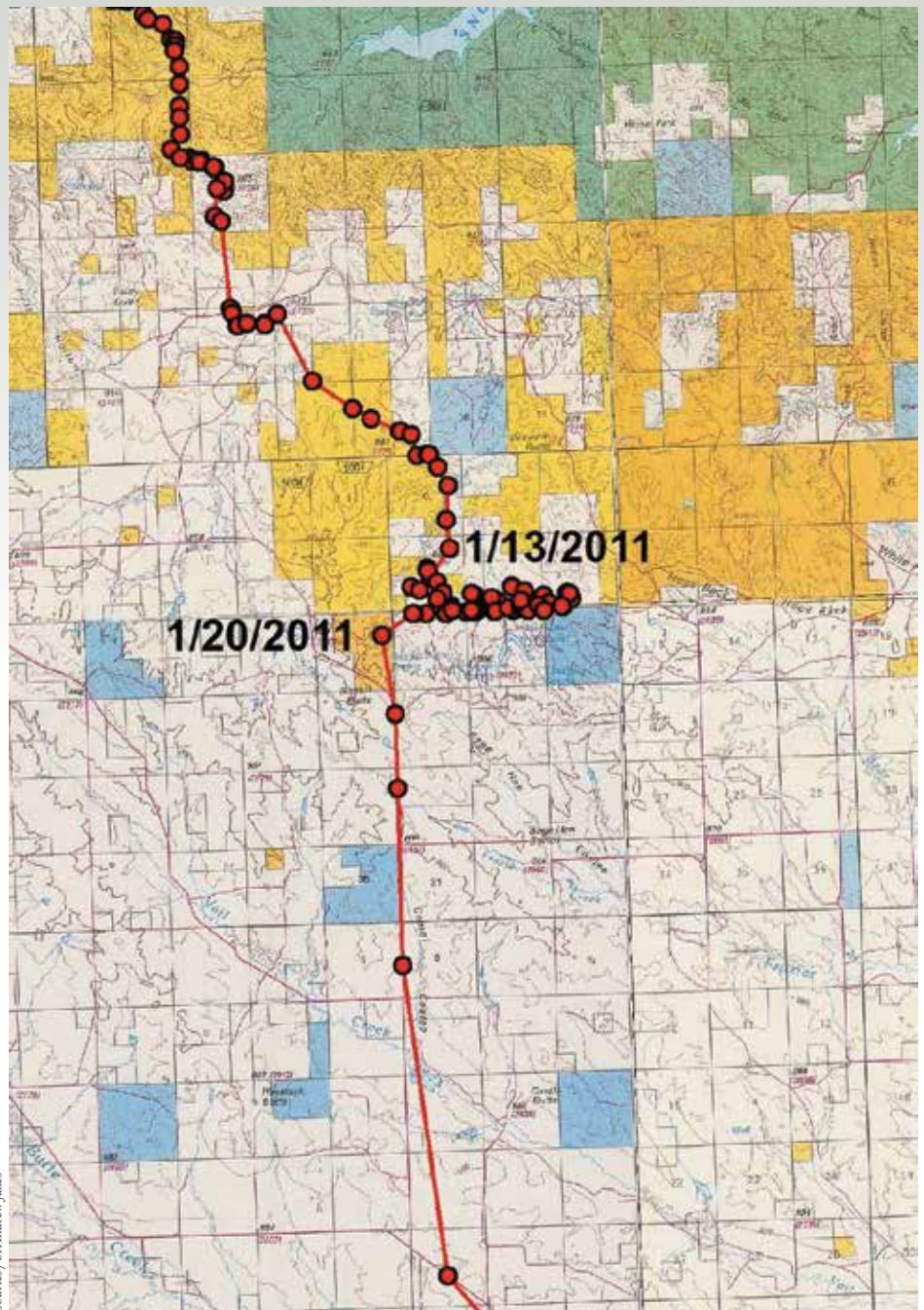

Courtesy of Andrew Jakes



Lay-Down Fence

A lay-down fence is a standard 3-wire or 4-wire fence that can be laid on the ground as a unit to allow ungulates to pass through during migration or seasonal use. A lay-down fence can also reduce snow and wildlife damage and save maintenance costs. Most designs allow a single person working alone to let the fence down or put it back up.

Lay-down fence can be constructed from smooth wire or barbed wire. Fence posts can be wooden or steel, but wood is more durable in heavy snow areas. Posts should be spaced at 16.5' intervals.

For barbed or smooth wire fence, one to two stays are needed between fence posts, plus a stay lined up with each fence post. Wire loops, secured at the top and bottom of the fence posts, support the fence stays. The lay-down section can then be dropped by flipping up the top loop and lifting the stays out of the bottom loop.

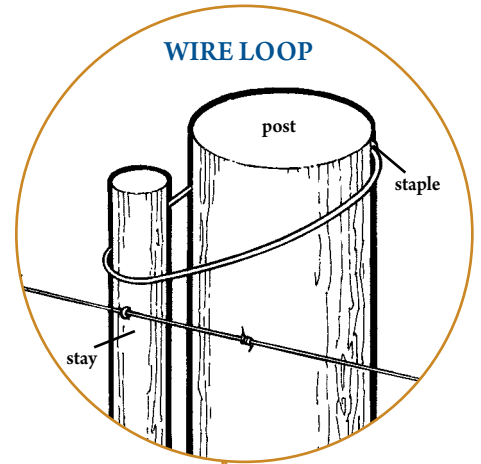

LAY-DOWN FENCE

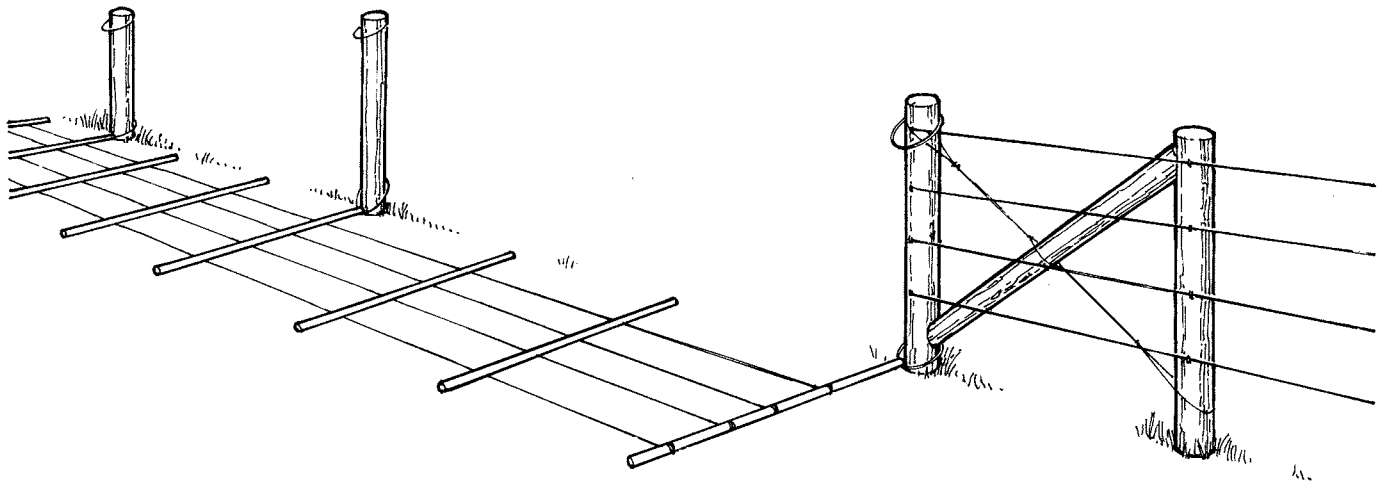
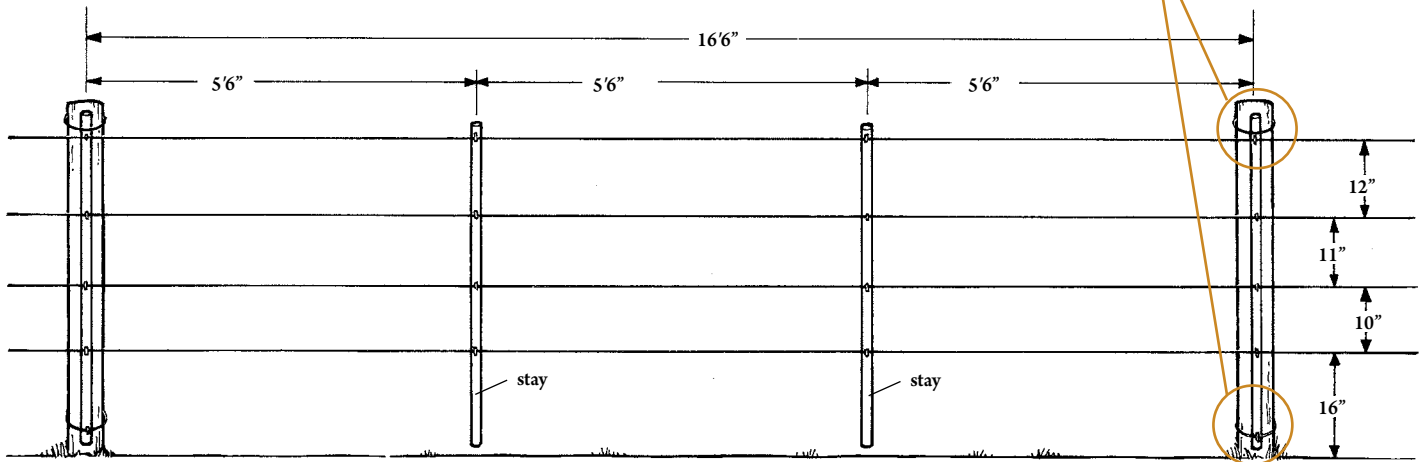



Montana Fish, Wildlife & Parks



Jay Kolbe

This lay-down fence using 4-strand smooth wire was constructed along 1.5 miles of fenceline next to the Blackfoot-Clearwater Wildlife Management Area in Montana to allow winter passage for elk. The number of elk tracks attest to the design's success.



Christine Paige



Friendly Designs

Durable PVC Big Game Passage

Installing PVC pipe over bunched fence wires is an inexpensive way to allow elk, deer, and antelope to freely cross existing barbed wire fence with minimal risk. **This design is especially useful where elk, moose, or other ungulates cross heavily traveled roadways and have difficulty crossing a fence. This delays them from moving out of danger, particularly in spring and summer when calves are small. Along roads, the PVC passage should be installed on both sides of the right-of-way.**

PVC pipe threaded over bunched fence wires creates an effective and durable big game passage, especially on road right-of-ways.



Montana Fish, Wildlife & Parks



Montana Fish, Wildlife & Parks





PVC Game Passage for Wire Fence

These instructions are for a metal t-post, 5-strand barbed wire fence, with no livestock present, but can be adapted for other situations.

Materials:

To modify two 60' sections of barbed wire fence.

- Twenty 10' sections of 1.5" OD PVC pipe
- One 100-count bag of large (7" or 11") UV-resistant plastic cable ties
- #16 or larger soft wire
- fencing pliers, wire cutter, leather gloves

Before Installation:

With a table saw, cut a 1/4" slot the entire length of each PVC pipe. Note that a 1/4" cut can be made by matching up two 1/8"-wide blades and using a wood guide.

Installation:

Step 1: Remove all wire clips from about 60' or three fence posts and allow wire to hang freely.

Step 2: Beginning near first post, with clips removed, grip the top three strands of wire and pinch together. Locate a space between barbs that will allow you to thread on the PVC pipe. Push pipe onto wire (not wire into pipe) concentrating on fore-end of pipe. If the pipe gets hung up on a barb at the fore-end, work barb into end of pipe and continue. Once the pipe has been adequately started, grip pipe near the fore-end and begin pulling down the length of the wire. The wire will feed itself into the pipe. Pull pipe down the wire until about 8' from where posts with clipped wires resume.

Step 3: Repeat with three more pipes. Space the joint between two pipes at a post where possible. This will allow you to clip the three wires together to a post.

Step 4: The last (fifth) pipe must be installed in the reverse direction. Starting near the end of the fourth pipe, find a space between barbs and install pipe as in Step 2, push into place 8' from where posts with clips resume.

Step 5: Repeat steps 2 through 4 with the bottom two wires.

Step 6: Using #16 or larger soft wire, attach the top PVC pipe to posts no more than 40" above the ground. Attach the bottom pipe at 18" above the ground, or dropped closer to the ground to create a larger middle gap for deer fawns or elk calves to go through rather than under. Where a joint between pipes is located at a post, enough space can be left to clip the wires to the post.

Step 7: Attach three cable ties per 10' section of PVC pipe, one near each end and one in the middle. Squeeze PVC pipe while pulling cable tie tight. Gap from cut will not be completely closed but will be small enough to allow the pipe to roll and not work its way off the wire. Clip tag end of cable tie.

Step 8: Repeat on opposite side of right-of-way.



An elk herd races to cross a highway. Animals are especially vulnerable to tangling when alarmed or crowded by others.

Shawn Bryant





Highway Right-of-Way Fence

Fences along state highway right-of-ways (ROW) present special challenges for landowners and wildlife. While fences protect livestock and crops, and keep livestock from entering the ROW and endangering motorists, some types of fence can restrict wildlife passage and migration, and animals trapped within the ROW are more likely to collide with vehicles.

Montana Department of Transportation (MDT) encourages the use of wildlife friendly fence designs that promote permeability for wildlife, allow animals to pass quickly out of the highway ROW, and minimize animal-vehicle collisions. Ideally, similar fence types should be placed opposite each other on either side of the ROW.

Depending on the situation, MDT can opt to:

- 1) replace existing and functional fence with a fence that is no more restrictive to wildlife movement than existing fence;
- 2) encourage landowners with functional ROW fence to replace the fence with wildlife friendly fencing in whole or at select locations;
- 3) replace dilapidated and non-functional ROW fencing with wildlife friendly fencing; or
- 4) not replace the dilapidated fence at all.

MDT currently offers several designs for wildlife friendly fence. The preferred design is four strands with top and bottom smooth wire and two center barbed wires; the top wire at 42," a 12" spacing

Wildlife Friendly Highway ROW Fence

Wildlife friendly fence and crossings should be placed on both sides of the ROW to allow animals to move quickly out of harm's way. Using wildlife friendly fence along highways:

- Allows wildlife to cross roadways easily and quickly.
- Reduces the time animals spend in the ROW.
- Reduces the chance of animals being trapped in the ROW.
- May reduce the number of animal/vehicle collisions.
- Maintains habitat connectivity for wildlife.
- Restrains domestic livestock from entering the ROW.
- Reduces wildlife damage to fences, reducing the need for fence maintenance.

between top and second wire, and bottom wire at least 16" off the ground. Landowners can choose to use one of MDT's standard designs or propose other wildlife friendly specifications that will work with their land use practices. MDT encourages landowners to use wildlife friendly fence either along the full length of their property along the ROW, or at a

minimum at regular intervals and known game pathways to provide crossings.

MDT is open to innovative solutions and will work with landowners to find solutions that accommodate their needs while providing wildlife movement across the highway corridor. Contact MDT Environmental Services for more information: (406) 444-7228.



Courtesy Montana Dept. of Transportation

Top and bottom smooth wires provide wildlife friendly passage where the Manley Ranch borders the Hwy 271 ROW near Helmville, Montana. The family reports that their cows respect the fence, wildlife pass through easily, and the fence hasn't required any maintenance.



Montana Fish, Wildlife & Parks

Wires gathered into PVC pipes create an easy big game passage on either side of the ROW when cattle are not present.



MDT Options for Wildlife Friendly Highway Right-of-Way Fence



John Carlson



Bert Lindler

An elk crossing with plastic-coated top and bottom wires allows quick passage out of the right-of-way, while center barbed wires still hold cattle.



Christine Paige

In some situations, the highway department may install wildlife jumps, which are one-way ramps that allow animals to escape the highway ROW.

Preferred Fence

Top and bottom smooth wires allow the easiest passage for wildlife. The standard wire heights are 16" - 18" bottom wire, 40" - 42" top wire, and 12" between the top two wires to minimize entanglements.

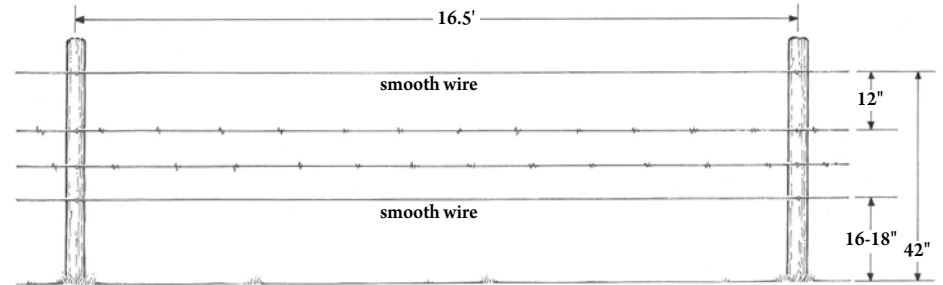

Basic All-Barbed Wire

In cases where all-barbed wire is needed, adjusted wire heights can make wildlife passage easier.

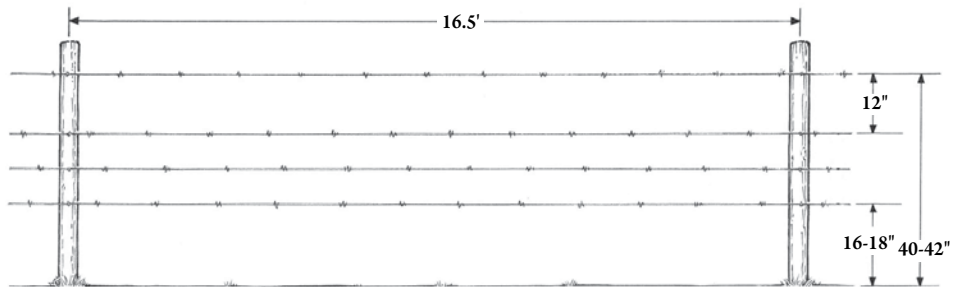

Pronghorn Fence

A smooth bottom wire at 16" - 18" minimum above the ground is recommended for pronghorn country, or where young ungulates are common.

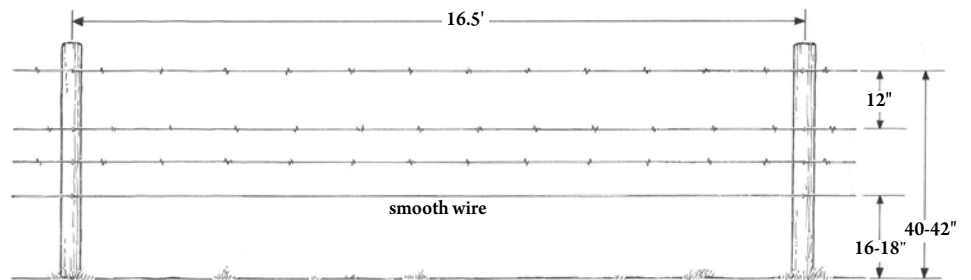

Fence for Sheep and New Calves

A 12" bottom wire should only be used in areas without pronghorn, or for operations where a low wire is necessary, such as for sheep and very young calves.

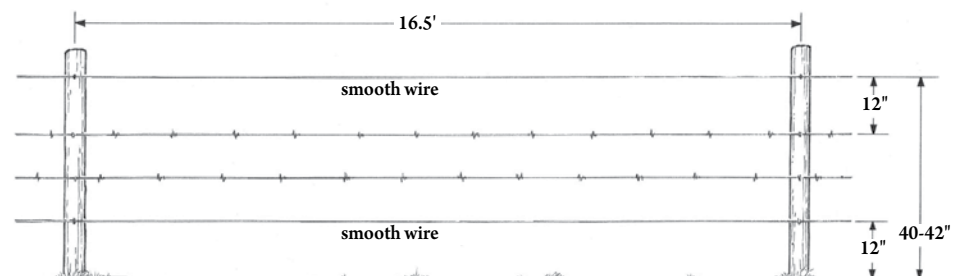

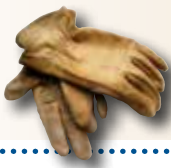

Wildlife Crossings for Established Fences Along Highway ROW

Wildlife Jumps, Underpasses, and Overpasses

Along major highways with high-speed traffic, the highway department may opt to install tall barrier fence with wildlife underpasses, overpasses, or jumps. This solution is very costly and

should only be employed where the risk of vehicle/wildlife collision is very high.

Underpasses and overpasses are major construction projects, and require thoughtful design and an understanding of wildlife behavior to be effective.

Wildlife jumps are ramps that allow animals to escape the highway ROW but prevent entry. Jumps should be placed at frequent intervals to minimize the time animals are searching for a way out of the ROW.

Wildlife friendly section: short of modifying an entire fence, sections of wildlife friendly design can be used in areas of known migration or movement.

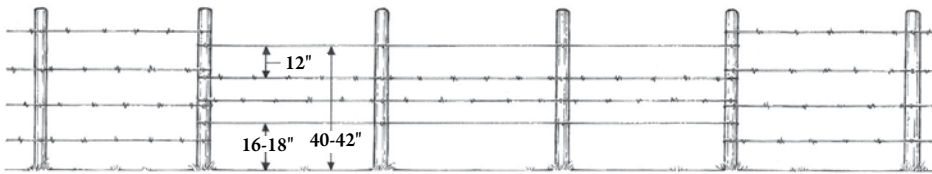

PVC wildlife passage: the top two and bottom two wires are gathered into PVC covers to create an easy passage. See full description on pages 37-38.

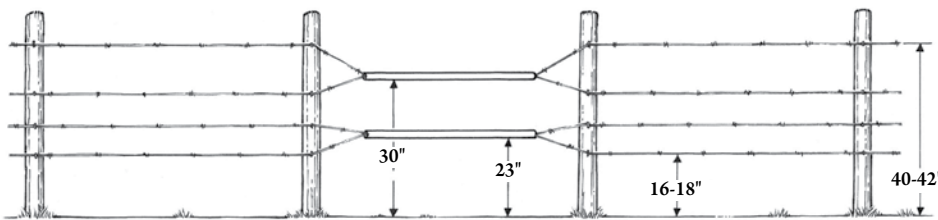

Dropped wire passage: staple locks can be used to drop top wire and/or raise the bottom wire for passage. See full description on page 29.

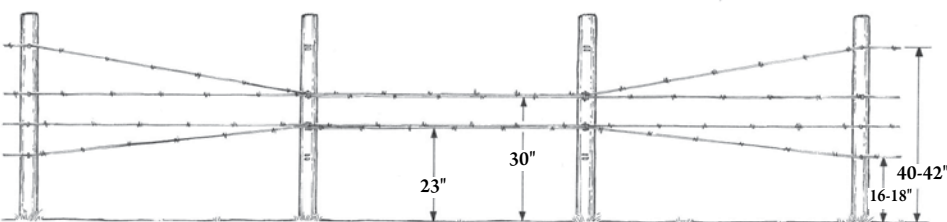

Working With MDT

MDT encourages the use of wildlife friendly designs, but will work with landowners to install appropriate fences for their land-use needs.

For each project, an MDT biologist considers the impacts of the ROW fence on wildlife movement patterns and landscape connectivity. The biologist evaluates the surrounding topography, road geometry, traffic volumes, adjacent habitat and land-use practices, existing fence types, animal-vehicle collision, and roadkill data. Based on this information, the biologist makes recommendations for wildlife mitigation strategies, including fence configurations.

An MDT ROW agent will meet with the landowner to negotiate ROW acquisitions for the project, and negotiate the type of ROW fence to be used along the property. The ROW agent and biologist coordinate to recommend an appropriate fence design that will work both for wildlife and the landowner. The biologist is also available to meet with landowners to discuss fencing recommendations or alternative solutions.

Currently, the ROW fencing is negotiable with the landowner. In some instances, MDT has placed the fencing on the MDT ROW in order to ensure implementation of the recommended fence design. If a fence is installed within the ROW, MDT maintains the fence, while the landowner is responsible for maintenance of the fence if it is placed on their property or at the ROW boundary.



Dropped Rail Wildlife Passage

Buck and rail or jackleg, post-and-rail, and worm or zigzag fences are often used for property boundary fences, but may be difficult for wildlife to negotiate. Often these fences are built too high, too wide, with extra wire, or with rails spaced too closely together for wildlife to pass through.

An occasional gap in the fence can provide a crossing, particularly when livestock are not present. Simply drop



Christine Paige

the top rails to the ground intermittently, such as every 100', to allow animals to step across. Animals will often move along the length of a fence seeking an

opening. Rails should be dropped where there are signs of wildlife passage, such as game trails, and in stream corridors, gullies, or other natural funnels.

DROPPED RAIL FOR WILDLIFE JUMP

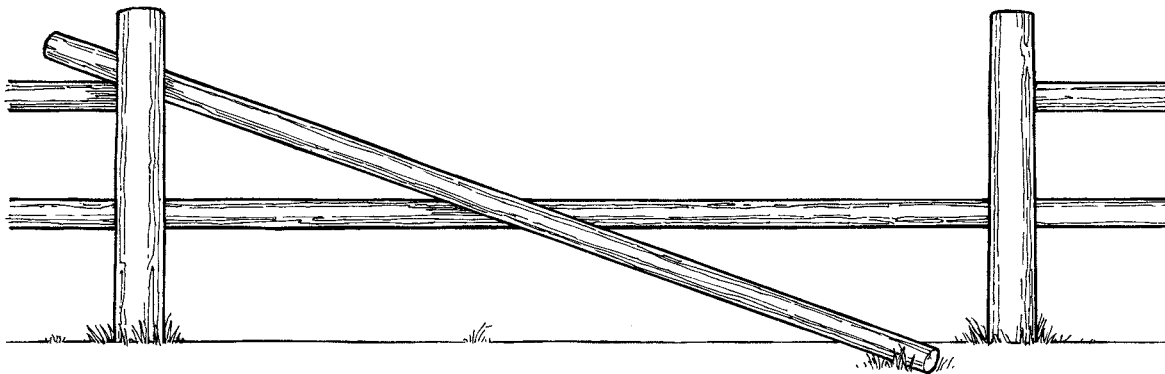

Wildlife can often see openings in a fence from a distance and will quickly learn to use these passages.



Christine Paige

DROPPED RAIL IN JACKLEG

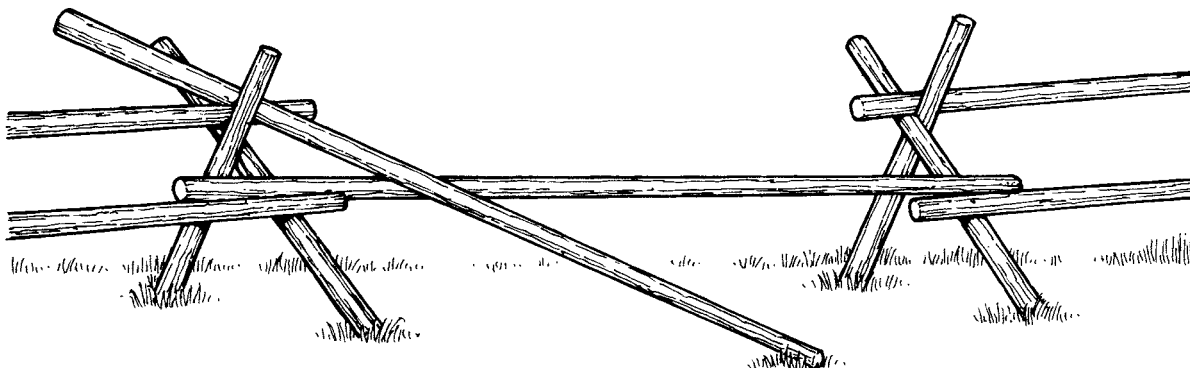

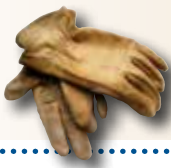

Remedies for Existing Fences

Remedies for Existing Fences

How can you make existing fences more wildlife friendly?

Fence maintenance, modifications, and removal can all help wildlife.

You can modify nearly any existing fence to be friendlier for wildlife. If you do not plan to completely replace an existing fence, you can alter individual sections to wildlife friendly standards to create crossings and easier passage.



Scott Nicolarsen

Remedies for Existing Fence

Maintenance:

- Keep wires tight. Sagging wires and neglected fences create a hazard for both domestic animals and wildlife. Loose wires can snare animals as they attempt to cross; tight wires reduce the chance of entanglement.

Modifications:

- Replace barbed wire with smooth wire, particularly for top and bottom strands. Smooth wire reduces the chance of animals getting snared on barbs and fatally entangled.
- Adjust the height of the top wire: preferably no more than 40" and a maximum of 42" above the ground.
- Increase the distance between the top two wires to 12" to reduce entanglements.

- Reduce the number of wires to three, or at most four.
- Add a top rail, high-visibility top wire, a PVC cover on the top wire, or flagging to increase visibility and prevent collision or entanglement.
- Raise the bottom wire to at least 16" and preferably 18" above the ground to allow animals to slip under.
- In selected fence sections, raise the bottom wire to the level of the third wire and secure with a staple lock.
- For pronghorn, gather bottom wires in a PVC pipe to create a "goat bar" underpass.
- Add wildlife crossings where wildlife trails cross fences by using dropped wires, dropped rails, lay-down fence, or underpasses, as described earlier.
- When livestock aren't present, secure gates open to allow free passage for wildlife.

- Provide wildlife access to rivers, streams, wetlands, and water holes, and through seasonal migration areas.

Removal:

- Remove old fences that are in disrepair or no longer in use. Remove any unnecessary interior fences.
- Bale and carry away piles of wire. Some recycling centers will recycle old wire. Never leave wire on the ground.
- Many volunteer groups are interested in helping with fence removal projects to help wildlife, such as local chapters of sportsman's groups, scout troops, 4-H, and others.



Christine Paige

3-Dimensional Buck Fence

Buck and rail (also called jackleg) or buck and wire fence designs should be avoided as they create a formidable barrier and hazard to wildlife. Any 3-dimensional design is especially hard to leap over or crawl through, and animals can tumble and break legs. Often, these fences are built too high, too wide, and with rails or wires placed too closely together for animals to negotiate easily.

Three-dimensional buck and barbed wire fence creates a particular entanglement hazard. If buck and rail is also combined with woven wire or barbed wire, or the fence is placed on steep terrain, it presents a complete barrier to wildlife.

Buck or jackleg fence also requires high maintenance: the wooden bucks and rails rot and collapse under snow loads and winds, and long stretches of wire may be pulled down by wildlife.

Some landowners like the look of buck and rail because it evokes tradition and history. However, buck fence should only be used for very short reaches and specific situations, such as wet or very rocky soils. Frequent crossings should be provided for wildlife.

Modifications for Buck and Rail Fence

- Place the top rail no higher than 40" and preferably lower.
- Allow a minimum of 18" between the bottom rail and the ground.
- Allow a gap of at least 18" between rails.
- Eliminate the horizontal rub rail in several sections or completely. It is not needed for fence stability, and wildlife can negotiate the fence more easily.
- Never add woven wire or barbed wire to the fence.
- Create frequent crossings for wildlife by dropping one end of the top rail to the ground, or using a section with two rails at 18" and 36".

Worm Fence

Worm fences, also called zigzag or snake fences, were used by early settlers because they are easy to construct and require no posts. Worm fences are still popular in some areas for their rustic nature, especially as boundary fences. They are not used to contain large livestock.

Although worm fences are more easily negotiated by wildlife than three-dimensional jackleg or buck and rail fences, they can still be a barrier to fawns, calves, and other animals. Other drawbacks include rotting, the excessive number of rails needed, the considerable space the fence takes up on the ground, and maintenance.

Worm fence is simply constructed of rails stacked alternately on top of one another, with the rails interlocked like laced fingers where the ends meet. The fence zigzags to give it stability, and



Christine Paige

A low worm fence is easily hopped by most ungulates. Drop the top rail to the ground every few hundred feet to allow smaller animals to cross.

it can be used where posts can't be driven into the ground. These fences are usually only 2' to 3' high, and are most often used in areas where local timber is readily available and the terrain tends to be rocky and uneven. If you use a worm fence, create openings for wildlife to cross by intermittently dropping rails to the ground.

Worm Fence

- Use three to four stacked rails per section, 8' to 11' long.
- Logs or split rails can be used. Rails split in a triangular manner add stability.
- Set the ends of each bottom rail on a rock or short log slightly above the ground to postpone decay.
- Interlace the rails at joints at a 30-degree angle.
- Stack rails only up to 2' to 3' high.
- If extra stability is needed, fasten rails together with 6" nails or spikes, and drive 4' lengths of ½" rebar into the ground on either side of the joint, flush with the top rail.
- Drop rails to the ground every 400', and in swales and at stream crossings for easy wildlife passage.

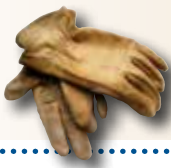

Remedies for Existing Fences

Wildlife “Death Pipes”

Open vertical pipes are silent and overlooked killers of birds and small animals. Hollow metal and plastic (PVC) pipes serve a wide variety of purposes, from ventilation pipes for buildings, outhouses, or irrigation systems, to fence posts, corner posts, gate uprights, and mining claim markers.

Birds, small mammals, and reptiles will investigate hollow pipes, especially for potential nest sites. Once inside they become fatally trapped, unable to find purchase on the pipe’s smooth walls. In 2009, for example, a biologist at the Audubon California Kern River Preserve found more than 200 dead birds in a fallen 50-year-old irrigation standpipe.

Most victims were cavity-nesting birds, such as bluebirds, woodpeckers, kestrels, and small owls. Because open pipes are so prevalent across our landscapes, the overall toll on birds and small animals may be in the millions.

Easy Fixes for Death Pipes

- Remove unused obsolete pipes.
- Permanently cap or fill pipes used as fence posts, gate uprights, sign posts, claim markers, or monuments. These can be capped with concrete, or entirely filled with sand, gravel or concrete. Chain link fence posts can be capped with commercial caps.
- Cover ventilation pipes on buildings, irrigation systems, and outhouses with galvanized hardware cloth held in place by steel pipe clamps, or install commercial vent caps.



Sean Rowe

CAPPING OR SCREENING OPEN VERTICAL PIPES PREVENTS BIRDS AND OTHER SMALL ANIMALS FROM BECOMING FATALLY TRAPPED.



Jeff King



Sean Rowe



Sean Rowe



Residential Fences

Fences serve many functions around homes, both aesthetic and practical: they may define a boundary, create a play space, contain pets, or discourage wildlife from yards and gardens.

Avoid fences with spikes, pickets, or barbs that protrude above the top bar. Many wrought iron fence designs have decorative spikes on top. Gauging a jump by the uppermost horizontal bar, animals can misjudge the fence height and be lethally caught or impaled on the fence.

Any tall residential fence, whether wrought iron, plank, picket, or chain-link, should be used only for small areas

around the home, and not for larger perimeter fences. If a fence provides a complete barrier, an open gate may allow animals to find a way in but not out. Be sure vertical planks or bars are spaced closely enough that animals will not try to push through and become trapped. Check city and county ordinances for fence regulations.

Many residential areas are in wildlife winter range. Using landscaping instead of fencing, or using only low, very permeable fences, allows wildlife to move freely through neighborhoods.

Photos below: Low, decorative yard fences pose little hazard or barrier to wildlife.



Colorado Parks and Wildlife

Iron fences with spikes or pickets are a lethal hazard for deer and other ungulates that wander neighborhoods. Cutting off or covering the spikes can reduce the hazard.

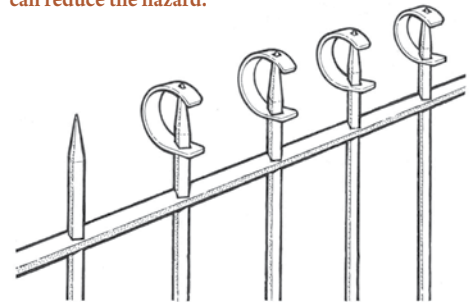

International Chimney Corporation created customized deer shields to modify a historic iron spiked fence for a client.



Christine Paige



Christine Paige



Christine Paige

A solid top rail and narrow vertical bars on this iron fence reduce hazards to wildlife.



Fence Alternatives

Hedgerows

If you do not need a fence to contain or exclude livestock, consider other creative ways to define boundaries and discourage trespass.

A line of shrubs or trees can mark a boundary line, beautify your landscape, and provide nest sites for birds and food and cover for wildlife. Depending on the site, a wide range of native and ornamental shrub species can be used to create an effective hedgerow – from lilacs and honeysuckle to willows, alder, and big sagebrush. Your County Cooperative Extension Office can help find local sources for plants and choose appropriate species for your site.

Many native shrubs are suitable for hedges and enhance wildlife habitat.

Beware using some non-native species that can become difficult or impossible to manage.



HEDGEROW

Mix it up: consider using several species, varying the width of the hedgerow, or using plants of different heights to create a natural and wildlife friendly hedge. Once established, hedgerows require minimal maintenance unless you want a highly manicured look.



Christine Paige

Boundary Markers

Where you do not need a fence, consider marking property boundaries with signs, flexible fiberglass or plastic boundary posts, or fence posts spaced at intervals but without cross wires.

Property boundaries can also be marked with steel t-posts or flexible fiberglass or plastic posts such as Carsonite (www.carsonite.com) or Flexstake posts (www.flexstake.com), available through survey and forestry suppliers. Commercial fiberglass and plastic marker posts are highly visible and durable. However, the cost per post can be greater than a heavy-duty steel fencing t-post.



Photo courtesy of Carsonite Composites

Posts can mark a boundary where fences are not needed. Flexible plastic posts can be ordered with reflective tape or custom lettering.

Barrier Posts

Barrier posts or bollards are short, stout posts spaced to prevent access by vehicles. They can be used to define a driveway or parking area, or edge an expanse of lawn. Posts can be spaced closely together, or placed farther apart and connected with a heavy chain, cable or rail, from two to three feet high. Bollards and posts with low chains or rails pose little deterrent or hazard for wildlife.

Bollards can be made of wood, concrete, brick, stone, cast iron, aluminum, or steel; a row of boulders serves the same function. Some can be installed as fixed or removable posts. A wide variety of bollard designs and ornamental covers are also available commercially.



Christine Paige



Christine Paige

A row of boulders or bollards (concrete or wooden posts) can prevent vehicle access but poses no barrier to wildlife.



If You Must Exclude

There are times when it is necessary to use exclusion fence to keep wildlife out.

If you must put up an exclusion fence, avoid fencing a large area that includes wildlife habitat. Focus exclusion fences on small areas for specific purposes, such as fencing around play areas, vegetable gardens, beehives, calving and lambing areas, or haystacks. Keep exclusion fence close to the activity you need protected, and allow wildlife to use other parts of the property.

For any exclusion fence, place gates at corners: an animal that inadvertently finds itself trapped inside is more likely to find escape through an open corner gate than through a side gate.



Christine Paige

Use chainlink fences only for specific purposes, such as play areas and dog kennels.

Wooden Plank Fence and Chainlink Fence

Chainlink fences and wooden fences with closely spaced vertical planks are especially unfriendly to wildlife and can create a complete barrier to animals of all sizes, from turtles to moose. If you must use chainlink or plank fences, limit their use to small enclosures.

Yard fences and play area fences often do not need to be more than 4' high. If higher, be sure gates are kept secured to prevent animals from finding their way in.

For small chainlink dog kennels, attach a roof to prevent wild animals from becoming trapped inside. A roof also provides shade and shelter for your pets.

Deer and Elk Exclusion Fence

A permanent non-electric exclusion fence for deer and elk should be 7' to 8' high. A 7' to 8' wooden fence that animals can't see through is typically used around housing areas. For gardens, vineyards, and other agricultural plots, 8' woven wire fence is more often used with posts set at 8' to 20' intervals, and the wire is brought tight to the ground. Make the top highly visible by using a top rail, high-visibility wire, or flagging. Place gates at corners, where an accidentally trapped animal is more likely to find an escape.

A 7' to 8' fence is an effective barrier to elk, but should be used only for specific needs, such as gardens or haystack yards. Make the top highly visible with flagging, white tape or wire, or a rail.



Christine Paige

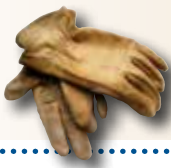

If You Must Exclude

Haystacks and Hay Yards

Several options exist for protecting haystacks from wildlife damage. These include electric, non-electric, temporary, and permanent designs.



Montana Fish, Wildlife & Parks

Deer-D-Fence

A traditional 8' woven wire fence can protect a stackyard from game damage. An alternative is a permanent 7-strand electric fence.

Temporary Solutions

A simple and cost-effective solution is to wrap haystacks with heavy-duty plastic mesh netting, such as Deer-D-Fence (www.tizergardens.com/distributing.html), a 2x2" durable plastic mesh that is strong, lightweight, and easy to handle. Haystacks and large bales can be wrapped quickly, and the netting is readily lifted off when not needed. This netting is especially useful for temporary applications, rapid installation, and remote settings.

Plastic netting can also be used instead of woven wire as fencing, and installed on wood or steel posts using UV-resistant zip-ties. The plastic is UV-resistant and durable, and materials cost is comparable to woven wire. However, labor costs for fence construction can be greater than with traditional materials.

Increase visibility by adding poly-coated wire, tape, or flagging when using plastic mesh as fencing. Although the mesh would cause little harm to most

large animals, it is nearly invisible when erected and should be flagged to be visible to birds.

Permanent Fences

Many landowners prefer to protect a large haystack yard with a permanent fence. The traditional stackyard fence is at least 8' high and uses woven wire with wood posts or a combination of wood and steel posts. One-way gates should be placed in the corners to allow animals that might be inadvertently trapped inside to find a way out more easily.

A permanent electric fence, 6' to 7' high, is also effective for protecting stackyards from game damage. This fence is constructed with high-tensile smooth wire spaced at 10" intervals with alternating hot and grounded wires.

A 7-wire fence 72" high with strands at 10" intervals is adequate for elk. Deer, on the other hand, require a higher fence of 84", with 8 to 9 wires.



Christine Paige



Larry Feight, High Country Ag, Marketing

Haystack Fence

- Use 10' pressure-treated wooden line posts, 3" to 4" in diameter, driven 2.5' into the ground, and spaced at 30' intervals.
- Use 10' pressure-treated wooden brace posts, 4" to 5" in diameter, driven 3' into the ground.
- Use 12.5-gauge, smooth Class III galvanized wire with a tensile strength of 170,000 PSI and breaking strength of 1,308 lbs. To increase visibility, use white poly-coated wire with the same specifications.
- Space seven strands at 10" intervals; the top wire at 72" for elk or 84" for deer; wooden posts require using insulators.
- Alternate hot and ground wires: bottom wire is grounded and top two wires are hot.
- Place solar energizer according to manufacturer recommendations.
- Ground fence properly according to the energizer instructions.
- Install electric fence warning signs.



Joe Weigand, Montana Fish, Wildlife & Parks

A permanent electric fence is an effective alternative to woven wire fence. A 6' fence with 7 strands at 10" intervals is adequate for elk.



If You Must Exclude

3-D Deer Fence for Yards and Gardens

Deer are not comfortable jumping fences with both height and depth, and are wary of fences that are not flat and regular. A **staggered picket fence or leaning fence can be an effective deer deterrent.** Another is to add tall vegetation – tall perennials, shrubs and trees – along a fence to increase the perceived depth of the barrier.

Another alternative is a 3-D electric deer fence, which can be effective for keeping white-tailed deer out of orchards and vegetable gardens. This fence is

3-D Deer Fence

- Place two separate lines of 4' fiberglass posts, the lines spaced 36" to 38" apart. Drive posts 16" to 18" into the ground.
- On the inner fence, string two 12.5-gauge high-tensile smooth wires at 12" and 28" above the ground.

- On the outer fence, place two wires at 12" and 24" above the ground.
- Make sure there is at least a 12' clearing in front of the outer fence so deer will see the fence. Flagging or high-visibility wire also help both deer and people see the fence.
- Install a solar energizer according to manufacturer's instructions.

basically two parallel fences only 36" to 38" apart, the outside slightly shorter than the inside fence. The 3-D fence can be constructed as a permanent fence with

high-tensile wire or as a temporary fence with poly-rope or tape and moveable posts.

3-D ELECTRIC DEER FENCE FOR YARDS AND GARDENS

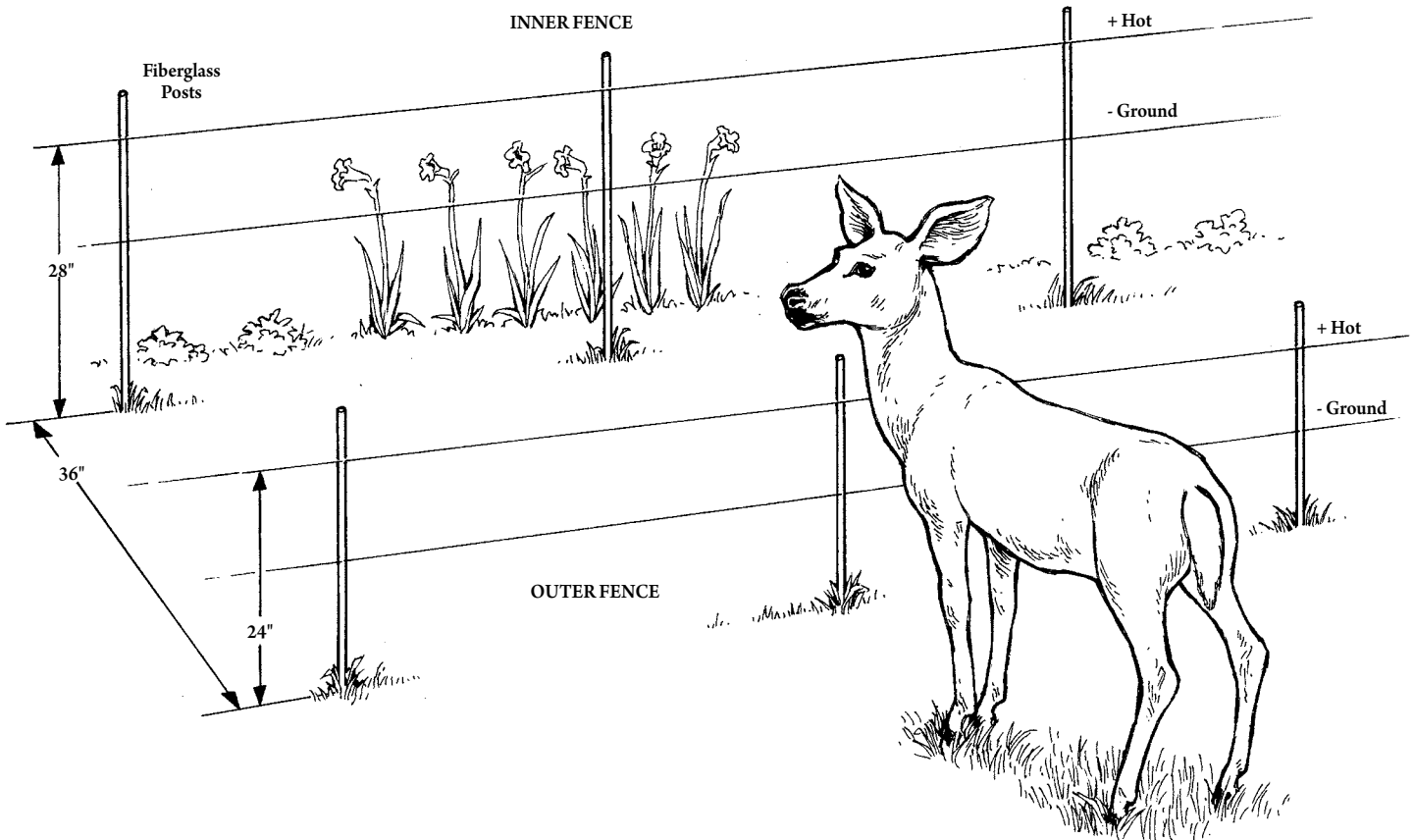



Deterring Large Predators

Many different permanent and temporary electric fence designs can deter large predators. These fences are used primarily for small-scale operations, such as beehives, dumpsters, lambing or calving areas, corrals, bone piles, and other small areas in need of protection from scavenging or predation.

A 7-wire permanent electric fence from 42" to 54" high is most commonly used to deter bears and wolves. In special situations, a higher 9-wire or 11-wire fence might be used. In dry, rocky soils, the fence should have alternating charged and grounded wires, with both top and bottom wires hot. In this setup, an animal must touch both a hot and a ground wire to receive a full shock. Use a grounded bottom wire if the wire is likely to touch vegetation. A fence with all hot wires can be used in areas with damp or moist soil that will provide sufficient grounding when the animal touches a hot wire.

The table at right shows specifications developed by the NRCS in cooperation with Montana Fish, Wildlife & Parks (NRCS 2006b). *(continued)*



Seth Wilson

Predator deterrent fencing should be used only around specific areas, such as corrals and beehives. Always hang warning signs on electric fences.



Seth Wilson

Bear and Wolf Deterrent Fencing

(Adapted from NRCS 2006B)

Charge and Recommended Wire Heights from Ground Level

| | Bear ¹ 7-wire | Bear & Wolf ² 7-wire | Beehive or Chicken Coop ³ 7-wire | Wolf & Bear ⁴ 9-wire (corral or home areas) | Wolf & Bear ⁴ 11-wire (away from corral or home areas) |
|------------------|-----------------------------|------------------------------------|---|---|---|
| Top wire | (+) 42" | (+) 54" | (+) 54" | (+) 60" | (+) 72" |
| 2nd wire | (-) 36" | (-) 42" | (-) 42" | (-) 50" | (-) 64" |
| 3rd wire | (+) 30" | (+) 32" | (+) 32" | (+) 42" | (+) 56" |
| 4th wire | (-) 24" | (-) 24" | (-) 24" | (-) 36" | (-) 48" |
| 5th wire | (+) 18" | (+) 18" | (+) 18" | (+) 30" | (+) 40" |
| 6th wire | (-) 12" | (-) 12" | (-) 12" | (-) 24" | (-) 32" |
| 7th wire | (+) 6" | (+) 6" | (+) 6" | (+) 18" | (+) 26" |
| 8th wire | | | | (-) 12" | (-) 20" |
| 9th wire | | | | (+) 6" | (+) 15" |
| 10th wire | | | | | (-) 10" |
| 11th wire | | | | | (+) 6" |

Bear¹ (42") 7-wire: Primary use is to deter grizzly and black bears; allows deer and elk passage.

Bear & Wolf² (54") 7-wire: Primary use is to deter grizzlies, black bears, and wolves from calving and lambing areas, but where wolf activity is low to moderate or there is potential for wolf activity.

Beehive or Chicken Coop³ (54") 7-wire: Primary use is to deter grizzly and black bears from apiaries.

Wolf & Bear⁴ (60-72") 9- or 11-wire: Primary use is to deter wolves and bears when predator activity or risk is high. Also useful for situations where ungulate damage to a lower fence (54") might be anticipated, or there is a predator issue.



© Henry H. Holdsworth/wildbynaturegallery.com



Deterring Large Predators



© Henry H. Holdsworth/wildbynaturegallery.com

Deterring Large Predators

(continued)

Key to the success of electric fences is to erect them before the attractant level is high, so that animals are “trained” to a fence early on. **Also, the amount of energy your setup can deliver over the full distance of the fence is crucial.** Because of predators’ thick fur, the system must deliver enough shock to deter them. For grizzlies, the system should deliver 6,000 volts or more, and will require an energizer with a rating of at least 0.7 joules. Be sure your energizer can deliver adequate power over the distance you need. Vegetation touching the wires and other factors can cause

energy drain. Regularly check the voltage on every hot wire with a high-quality voltage tester, especially midway and at the farthest distance from the energizer. In addition, **always install warning signs on the fence.**

For more complete instructions and appropriate designs, see *Bears and Electric Fencing* published by Montana Fish, Wildlife & Parks, available online at <http://fwp.mt.gov/fishAndWildlife/livingWithWildlife/beBearAware/bearAwareTools.html> (Annis 2010). Also see *Practical Electric Fencing Resource Guide: Controlling Predators* published by the Living with Wildlife Foundation and available online at <http://www.lwwf.org> (Thompson, et al. 2005).

Fladry to Deter Wolves

Fladry is a line of wire strung with long flags or streamers used to deter predators from livestock. Fladry’s advantage is that it is portable, temporary, and requires comparatively little planning. It serves best as a short term deterrent until a more permanent fence can be planned and installed.



Steve Primm



Tim Manley

Chicken coops and beehives can be irresistible to bears, but a high-energy electric fence is effective protection.



Steve Primm



© Henry H. Holdsworth/wildbynaturegallery.com



Steve Primm



Deployed around temporary pastures, fladry has been shown to deter wolves for up to 60 days, and much longer if electrified. Be aware that this technique can have considerable problems with deployment, tangling, power drain, general availability, and high initial capital and labor costs. However, because it is portable and temporary, a number of western ranchers have found it to be an effective tool to protect livestock from wolves (Primm and Robinson 2011).

Fladry

- Use a large spool or reel (6" minimum diameter and 11" minimum width) to coil and deploy fladry. Handling by hand is enormously time-consuming.
- Electrified fladry ("turbo fladry") has a longer period of effectiveness, and deters livestock from trampling the line.
- Use $\frac{3}{8}$ " x 4' fiberglass rod posts.
Tip: Carry these in an old golf bag to deploy in the field.
- Line height should be no higher than 28," and fladry flags should hang above the ground. In spring and summer it is difficult to keep flags from touching vegetation.
- To secure the line, use a "harp clip," which allows the fladry flags to slide through the clip. See <http://www.premier1supplies.com> for an effective harp clip.
- For anchor posts, use thicker composite posts with wire clips, steel t-posts with insulators, or insulators on permanent wooden posts of existing fence.
- Create gates using anchor posts and good quality electric fence handles connected to an eye-bolt on the post.
- Electrify with an energizer that will provide an output of at least one joule per mile of fladry.
- A "wide impedance" energizer will deliver more consistent voltage under adverse conditions, such as dry soils, dry snow, cold temperatures, and long insulating fur.





Getting Help

Getting Help

Montana Fish, Wildlife & Parks Private Land Technical Assistance Program can contribute information, technical assistance, staff support, and sometimes cost-share to projects that reduce conflicts with wildlife and enhance wildlife habitat on private lands. Other FWP game damage and habitat enhancement programs may also be avenues to find support for wildlife friendly projects. Contact FWP Wildlife Bureau at (406) 444-3065 or your local FWP field office.

The Natural Resources Conservation Service (NRCS) offers cooperative programs to address natural resource concerns, including improvements to wildlife habitat. NRCS can provide technical and financial assistance for many types of enhancement projects, including wildlife friendly fence construction and modification. The NRCS works on a voluntary basis with private landowners. See www.mt.nrcs.usda.gov to learn more about their programs and contact information for your local NRCS Field Office.

The Montana Department of Transportation works cooperatively with landowners to construct or modify fences along state highway right-of-ways to wildlife friendly standards. Contact MDT Environmental Services for more information at (406) 444-7228.

In addition, check with your local County Cooperative Extension Office for technical assistance and information on landowner programs. If you share a boundary with federal lands or lease a federal grazing allotment, contact the agency's local office to inquire about opportunities for cooperative projects to replace or modify fences to be wildlife friendly.

Many sportsmen's clubs, civic groups, or conservation organizations may also be interested in helping to provide either cost-share support or volunteers for wildlife friendly fencing projects to enhance wildlife habitat.



Scott Nicolaisen



Mark Gocke

Many land trusts, sportsmen's clubs, community groups, and conservation organizations may be able to help with technical assistance, staff support, and small grants on wildlife friendly projects.



Bert Lindler



Sources

- Allen, G.T. and P. Ramirez. 1990.** A review of bird deaths on barbed wire fences. *Wilson Bulletin* 102(3):553-558.
- Annis, K. 2010.** Bears and Electric Fencing: A starter's guide for using electric fencing to deter bears. *Montana Fish, Wildlife & Parks*. 12 pp. Available online at: <http://fwp.mt.gov/fishAndWildlife/livingWithWildlife/beBearAware/bearAwareTools.html>.
- Christiansen, T. 2009.** Fence marking to reduce greater sage-grouse (*Centrocercus urophasianus*) collisions and mortality near Farson, Wyoming – summary of interim results. Wyoming Game and Fish Department, Green River, WY. 3 pp.
- Colorado Division of Wildlife. 2007.** Fencing with wildlife in mind: understanding the impact on wildlife when fencing your property. Colorado Division of Wildlife, Living With Wildlife Program. Brochure, 9 pp. Available online at: <http://wildlife.state.co.us/NR/rdonlyres/B0D65D61-6CB0-4746-94F1-6EE194E1C230/0/fencing.pdf>.
- Ehmke, C. 2009.** If You Fence It, They'll Stay out: Fencing Out Stock in Wyoming. Univ. Wyoming Cooperative Extension Service. 2pp. Available online at: uwadmnweb.uwyo.edu/CESFRM/IfYouFenceIt.pdf.
- George Miksch Sutton Avian Research Center. 2006.** Fence marking for lesser prairie-chickens: a cooperative conservation solution. Sutton Avian Research Center, Bartlesville, OK. 2 pp. Available online at: http://www.suttoncenter.org/fence_marking.html.
- Gillihan, S.W. 2000.** Barbed wire fence fatal to burrowing owl. *J. Colorado Field Ornithologists*. 34(4):220-221.
- Harrington, J.L. 2005.** Characteristics of ungulate behavior and mortality associated with wire fences. Master's thesis, Utah State University, Logan, UT. 48 pp.
- Harrington, J.L., and M.R. Conover. 2006.** Characteristics of ungulate behavior and mortality associated with wire fences. *Wildlife Society Bulletin* 34(5):1295-1305.
- Karhu, R. and S. Anderson. 2003.** Evaluation of high tensile electric fence designs on big game movements and livestock containment. Final Report April 2003. Wyoming Cooperative Fish and Wildlife Research Unit. Laramie, WY. 27 pp.
- Karhu, R. and S. Anderson. 2006.** The effect of high-tensile electric fence designs on big-game and livestock movements. *Wildlife Society Bulletin* 34(2):293-299.
- Karsky, Dick. 1988.** Fences. Publication #8824 2803. U.S. Department of Agriculture, Forest Service, Missoula Technology and Development Center, Missoula, MT. 210 pp. Second printing 1999. Available online at: <http://www.fs.fed.us/eng/pubs/pdfpubs/pdf88242803/pdf88242803d-pi300.pdf>.
- Montana Code Annotated. 2011.** § 81-4-101. Legal fences defined.
- Montana Code Annotated. 2011.** § 81-4-201. Animals running at large.
- Montana Dept. of Fish, Wildlife & Parks. 2002.** Fencing specifications for FWP properties. Internal document. 4 pp. MT Dept. of Fish, Wildlife & Parks, Helena, MT. October 25, 2002.
- Mosley, J. 2011.** Livestock fence laws: in versus out. *Big Sky Small Acres* 5(2):12-13.
- Nero, R.W. 1974.** Great gray owl impaled on barbed wire. *Blue Jay* 32(3):178-179.
- Nesbitt, S.A. and D.T. Gilbert. 1976.** Powerlines and fences hazards to birds. *The Florida Naturalist*. April: 23.
- North Dakota Game and Fish Dept. 2006.** Pronghorn management guide-2006: Biological and management principles and practices designed to sustain pronghorn populations from Canada to Mexico. North Dakota Game and Fish Department. 158 pp. Available online at: <http://gf.nd.gov/multimedia/pubs/prong-mgmt-guide-pdf-ndx.html>
- NRCS. 2006a.** Natural Resources Conservation Service Conservation Practice Specification: Permanent Power Fence. Code 382(b)-1 of 5. May 2006. Natural Resources Conservation Service, Wyoming. 7 pp.
- NRCS. 2006b.** Natural Resources Conservation Service General Specification Power Fence. Fence (Feet) Code 382. Specification MT-382 (Power Fence), April 2006. 3 pp. Natural Resources Conservation Service Montana. Available online at: http://efotg.nrcs.usda.gov/references/public/MT/382_spec_Power_2006.pdf.
- NRCS. 2010.** Animal Enhancement Activity – ANM27 – Wildlife friendly fencing. Natural Resources Conservation Service. 2 pp.
- Paige, C. 2008.** A Landowner's Guide to Wildlife Friendly Fences. Landowner/Wildlife Resource Program, Montana Fish, Wildlife & Parks, Helena, MT. 44 pp.
- Patla, S. and D. Lockman. 2004.** Considerations and prescriptions for the design, construction and management of shallow water wetlands for spring through fall use by trumpeter swans (*Cygnus buccinator*) in western Wyoming. Report, Nov. 2004. Wyoming Game and Fish Department, Jackson, WY and Wildlife Services of the Rockies, Cheyenne, WY. 9 pp.
- Primm, S. and A. Robinson. 2011.** Electrified fladry for deterrence of gray wolves (*Canis lupus*): an evolving manual of best practices. People & Carnivores Program, Northern Rockies Conservation Cooperative & Sun Ranch Institute. 15 pp. Available online at: <http://peopleandcarnivores.org/>.
- Quitmeyer, C.J., J.A. Bopp, R.M. Stephens, R. Karhu and S. Anderson. 2004.** High tensile electric fence: phase 2 – liability issues, maintenance costs, and containment of bison. Final Report December 2004. Wyoming Cooperative Fish and Wildlife Research Unit. Laramie, WY. 85 pp.
- Schmidt, L. and J. Knight. 2000.** Electric fencing to control deer and elk on Montana's farms and ranches. Montana State University Extension Service. 4 pp. Available online at: www.co.yellowstone.mt.gov/extension/ag/pubs/mt200010.pdf.html.
- Sheldon, D.P. 2005.** Movement and distribution patterns of pronghorn in relation to roads and fences in Southwestern Wyoming. Master's thesis, Department of Zoology and Physiology, University of Wyoming, Laramie, WY. 140 pp.
- Stevens, B.S. 2011.** Impacts of fence on greater sage-grouse in Idaho: collision, mitigation and spatial ecology. Master's thesis, College of Graduate Studies, University of Idaho, Moscow, ID. 210 pp.
- Stevens, B.S., J.W. Connelly and K.P. Reese. 2012a.** Multi-scale assessment of greater sage-grouse fence collision as a function of site and broad scale factors. *J. Wildlife Management*. doi: 10.1002/jwmg.397
- Stevens, B.S., K.P. Reese, J.W. Connelly, and D.D. Musil. 2012b.** Greater sage-grouse and fences: Does marking reduce collisions?. *Wildlife Society Bulletin*. doi: 10.1002/wsb.142.
- Thompson, S., J. Jonkel and P. Sowka. 2005.** 2005 Edition Living with Predators Guide. Practical Electric Fencing Resource Guide: Controlling Predators. Living With Wildlife Foundation, Swan Valley, MT. 38 pp. Available online at: <http://www.lwwf.org>.
- Washington Dept. of Fish and Wildlife. 2004.** Make your fence wildlife friendly. *Crossing Paths Newsletter*, Fall 2004.
- Wolfe, D.H., M.A. Patten, and S.K. Sherrod. 2009.** Reducing Grouse Collision Mortality by Marking fences (Oklahoma). *Ecological Restoration* 27(2):141-143.
- Wyoming Game and Fish Dept. 2004.** Fencing guidelines for wildlife. Revised version. Habitat Extension Bulletin No. 53. Wyoming Game and Fish Dept. 12 pp.

For more information or assistance, contact your local FWP office, wildlife biologist, or warden.

Joe Weigand, Private Land Wildlife Specialist, can also be reached at (406) 444-3065, or email joweigand@mt.gov.



donaldjones.com



**Montana Fish,
Wildlife & Parks**

1420 East 6th Avenue
P.O. Box 200701
Helena, MT 59620-0701