

United States  
Department of  
Agriculture

**Forest Service**

Technology &  
Development  
Program

2300 Recreation Mgmt  
August 2004  
0423 1201—SDTDC



# Riparian Restoration

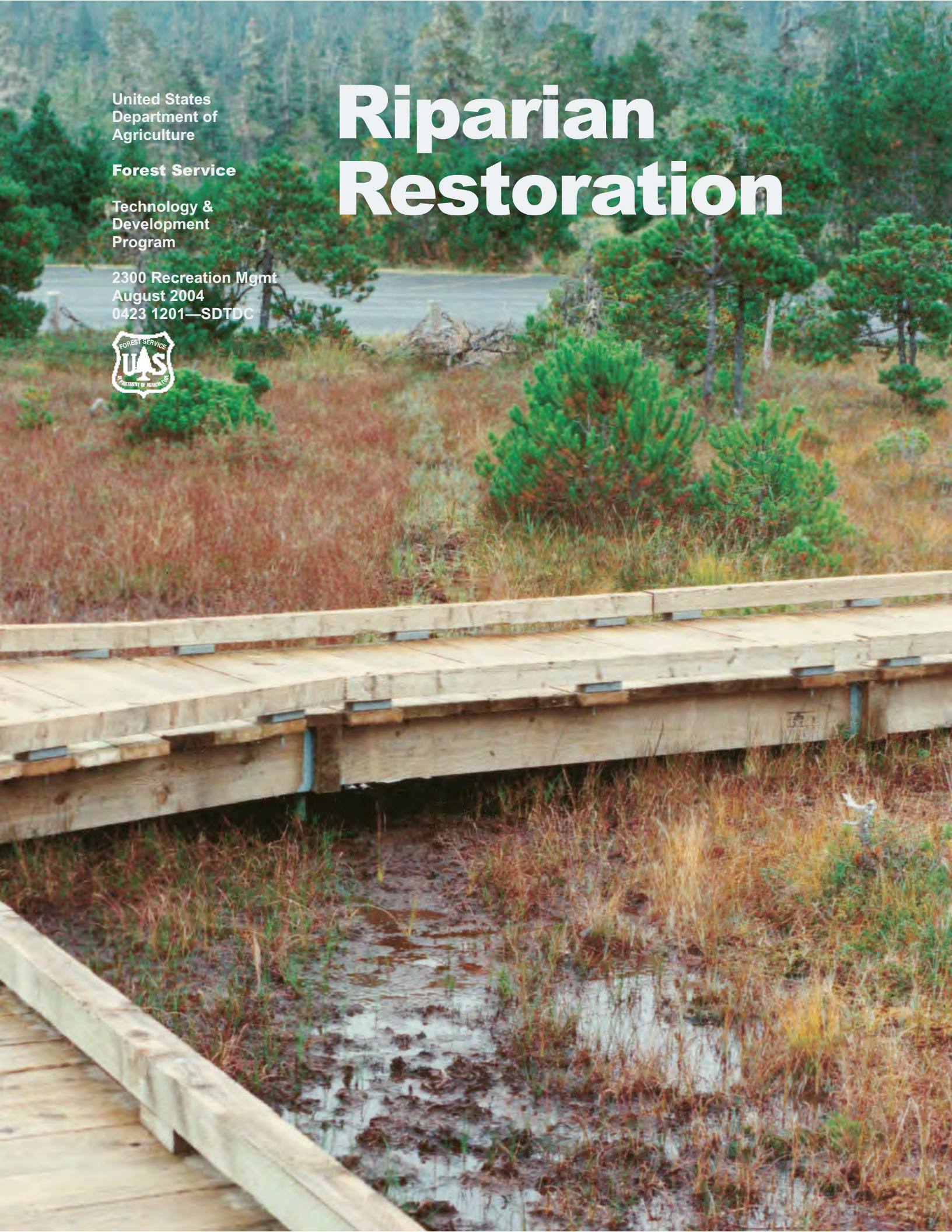



# Riparian Restoration

**U.S. Department of Agriculture Forest Service  
Technology & Development Program  
444 East Bonita Avenue  
San Dimas, CA 91773  
<http://fsweb.sdt dc.wo.fs.fed.us>**

By:  
Ellen Eubanks  
*Landscape Architect*

---

Information contained in this document has been developed for the guidance of employees of the U.S. Department of Agriculture (USDA) Forest Service, its contractors, and cooperating Federal and State agencies. The USDA Forest Service assumes no responsibility for the interpretation or use of this information by other than its own employees. The use of trade, firm, or corporation names is for the information and convenience of the reader. Such use does not constitute an official evaluation, conclusion, recommendation, endorsement, or approval of any product or service to the exclusion of others that may be suitable.

The U.S. Department of Agriculture (USDA) prohibits discrimination in all its programs and activities on the basis of race, color, national origin, sex, religion, age, disability, political beliefs, sexual orientation, or marital or family status. (Not all prohibited bases apply to all programs.) Persons with disabilities who require alternative means for communication of program information (Braille, large print, audiotape, etc.) should contact USDA's TARGET Center at (202) 720-2600 (voice and TDD).

To file a complaint of discrimination, write USDA, Director, Office of Civil Rights, Room 326-W, Whitten Building, 1400 Independence Avenue, SW, Washington, D.C. 20250-9410 or call (202) 720-5964 (voice and TDD). USDA is an equal opportunity provider and employer.



Preface .....	v
Acknowledgements .....	vii
Introduction .....	ix
Chapter 1: Ecological Integrity .....	1
Chapter 2: Impacts .....	9
Chapter 3: How Recreation Impacts Affect Key Characteristics of Riparian Ecosystems .....	17
Chapter 4: Restoration Preparation .....	27
Chapter 5: Restoration Techniques .....	43
Glossary .....	63
Appendixes .....	71
Appendix A: Impacts of Recreation on Developed and Dispersed Sites .....	72
Appendix B: Handling Plant Materials; Harvesting, Storing, and Installing Cuttings .....	76
Appendix C: Waterjet Stinger .....	78
Appendix D: Pest and Weed Control .....	92
Appendix E: Split Rail Fences and Barriers .....	94
Appendix F: Campsite Monitoring Instructions .....	102
Appendix G: Techniques for Plant Establishment in Arid Ecosystems .....	110
Appendix H: Additional Information .....	123



## PREFACE

This guide was written for staff, managers, technicians, permittees, concessionaires, and volunteers—for anyone engaged in activities that could affect the health of a riparian ecosystem. It provides the basic principles and background information needed to carry out a restoration project.

The objectives of the guide are to:

- ◆ Create an awareness of riparian values and ecosystems and how they function.
- ◆ Show common impacts from recreation.
- ◆ Provide examples of planning, design, and restoration techniques.
- ◆ Foster an understanding of adapted management and of monitoring concepts.





## ACKNOWLEDGEMENTS

This publication advocates a team approach. I want to thank my “team”, those who answered all my questions, lead tours, shared photographs, and shared experiences and expertise. They are George Toyama, J. Chris Hoag, John Rieger, John Stanley, Louise Johnson, Sue Fritzke, Sue Beatty, Don Fox, Howard Mueller, Sally Champion, Russ LaFayette, Gary Bentrup, Marti Dodds, Jeffery Halstead, Reggie Fletcher, and Steve Paustian. Special thanks goes to Dexter Meadows for his council and support.



## INTRODUCTION

Riparian restoration is a process that sets the stage to allow natural ecological processes to occur and to continue once the riparian habitat is reestablished. Beschta states that “Riparian restoration [is] the reestablishment of riparian functions and related physical, chemical, and biological linkages between terrestrial and aquatic ecosystems; it is the repairing of the diversity and dynamics of indigenous ecosystems degraded by human impacts. Its goal is to ensure that the dynamics of natural ecosystem processes are again operating efficiently so that both ecosystem structure and functions can be recovered and sustained” (Beschta and others 2000). Continuing these processes is “a necessity for maintaining a [eco]system’s long-term economic and social values” (Ibid).

Two themes—riparian and restoration—are explored. The guide develops the concept of ecosystems as complex systems that are inherently dependent on each other for existence and emphasizes the value of ecology and ecological integrity. It outlines a different approach to setting boundaries for riparian ecosystems and introduces the structural and functional characteristics as keys to understanding them. The supposition is that by understanding the components that give ecosystems form (structure) and the interactions between these components (function), it may be possible to fix (restore) the damaged parts and make them function properly again.

The guide offers tips for investigating existing site conditions to discover what is working well (functioning properly) and what is not. Using the guide will help guard against disturbing natural functioning conditions, when new construction is being planned. To help achieve the desired results, the guide offers recommendations for setting goals and identifies objectives and a set of design principles. Restoration techniques to return wornout, trampled, and dehydrated areas to vibrant, healthy, productive, eco-participants are explained in detail. Photos, charts, graphs, and tables aid in understanding the material presented here, as well as the concepts, planning, and implementation of individual restoration projects. The appendixes list additional sources for information and assistance.

This guide was prepared to assist specialists (soil scientists, biologists, landscape architects, engineers,

hydrologists, botanists, and others) who are involved in day-to-day management of recreation areas and who have the responsibility for protecting the natural environment, while planning for public use. It provides a broad overview of restoration concepts as well as in-depth, how-to assistance.

This Nation’s diverse riparian ecosystems, from mountains to deserts, flourish with bountiful populations of wildlife and diverse plant communities. See figures 1, 2, and 3. Riparian ecosystems serve as classrooms for lessons in the complex ecology of interrelated and interdependent ecosystems. For example, the most innocent or innocuous acts can impact riparian ecosystems and, ultimately, the water we drink. Disruptive acts include fertilizing farmlands; careless logging and mining; mowing lakeshores, riverbanks, and streambanks; removing shrubs and trees; constructing access roads and trails for recreation; fishing from streambanks; camping at the water’s edge; and participating in other recreational activities that can disrupt riparian ecosystems.



Figure 1—Desert riparian.



Figure 2—Midwestern lakeshore riparian.



Figure 3—Grassland riparian.

Careless and irresponsible recreation is as damaging, and has the potential to be more damaging, to plant and animal life as certain types of logging and mining. An array of recreational impacts that often go unnoticed can eventually cause grave consequences in efforts to restore riparian ecosystems.

Riparian ecosystems are the canaries in the coal mine. They give warnings of erosion and pollution problems that threaten forest streams, rivers, lakes, and ocean fronts. When water quality is impacted, the fundamental ecology is deeply disturbed. For example, Manning (1979) notes that “sheet erosion carries away the soil surface preventing accumulation of litter and organic material.” This contributes to water pollution. See figures 4 and 5.



Figure 4—The campground straddles the stream. The riparian vegetation is being destroyed and the soil compacted, thus destroying the riparian ecosystem and the environment that drew people in the first place.

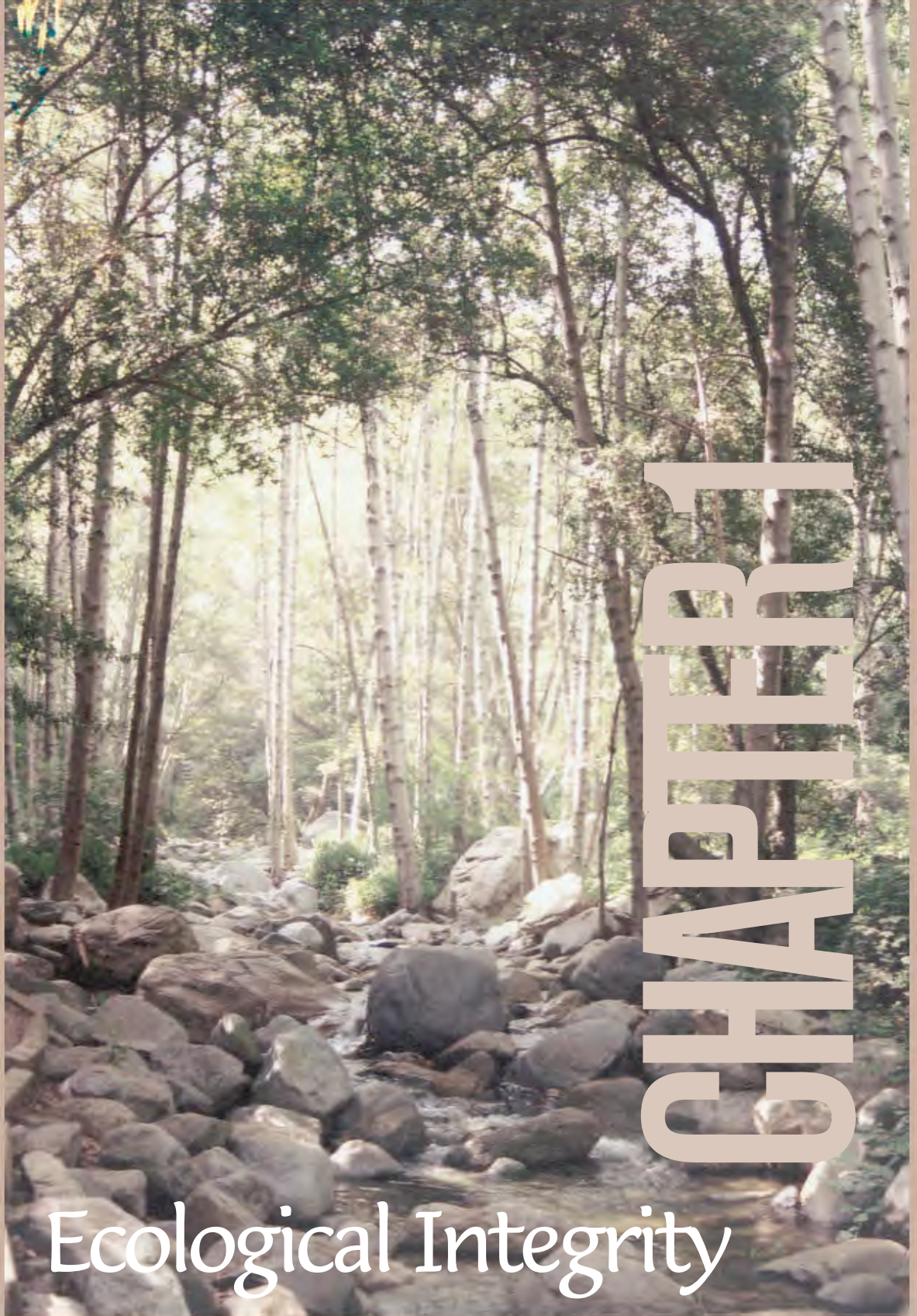

Figure 5—Shrubs and herbaceous vegetation along this stream have been trampled.

Riparian ecosystems are a more valued resource to the general public and to those persons with grazing permits than any other forest environment. They offer unparalleled wildland recreational opportunities. They are important for flood mitigation and water quality

control and for regulating the movement of water, sediment, minerals, and woody debris between terrestrial and aquatic ecosystems. They offer critical habitat and food sources to a diverse population of wildlife, including fish and fowl, plant species, and humans.





# CHAPTER 1

Ecological Integrity

# ECOLOGICAL INTEGRITY

This chapter suggests a broad interpretation of the riparian ecosystem and its influences. Often riparian ecosystems are described as land and vegetated areas associated with lakes, streams, rivers, and wetlands that have complex ecosystems and provide food, lodging, and travel corridors for both aquatic and terrestrial species. It is not limited to delineating riparian ecosystems as being 50 or 100 feet from a river's edge. Readers are challenged to develop an understanding of the structural and functional characteristics of this type of ecosystem and their key roles in maintaining ecological integrity. See figure 6.

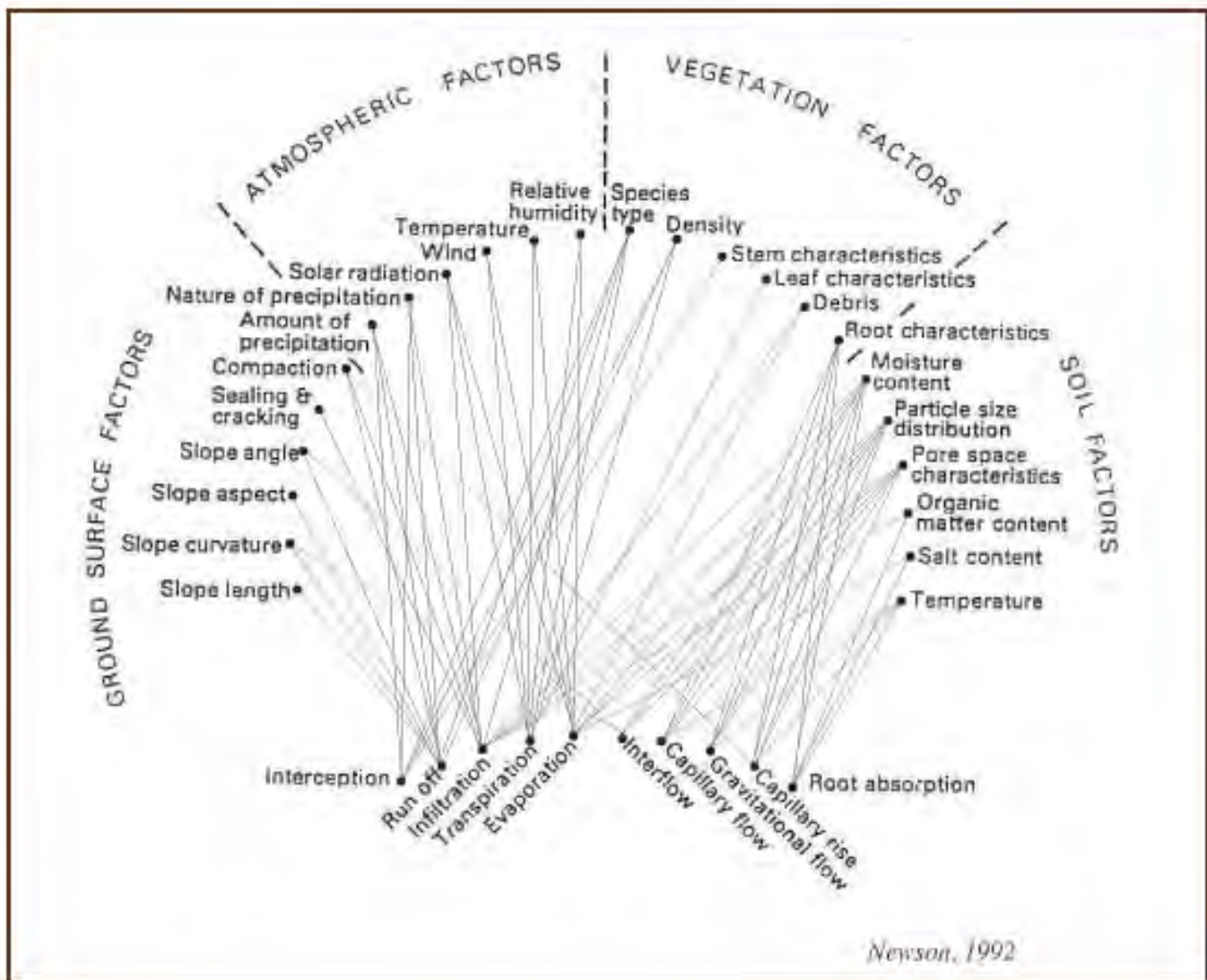

Figure 6—This drawing illustrates how each factor impacts and influences the others, thereby strongly influencing riparian ecosystem health (Ward 1975).



The influences on the riparian ecosystem should be viewed topographically from upstream to downstream, from upslope to downslope, and from subsurface up through the vegetated canopy. This concept is better expressed as the longitudinal, lateral, vertical, and temporal influences. See figure 7.

- ◆ The longitudinal influence extends the length of the stream.
- ◆ The lateral influence begins in the water body and extends through the riparian vegetation, into the upland forest or dry land vegetation, to the point where overland flow (runoff) is initiated.

- ◆ The vertical influence extends below the dry-season water table and through the canopy of mature vegetation. In certain settings, grass may be the naturally mature vegetation; in others, it may be cacti or scrubby trees.
- ◆ Temporal influences are changes to the riparian ecosystem over time. Riparian ecosystems are not tied to a specific distance from the water's edge but rather to changes in vegetation type, soil type and moisture availability, and other ecological characteristics. Structural and functional characteristics combine to create ecological integrity for the riparian landscape. If the structure or function is compromised, the consequences will be apparent in the degradation of the area. See figures 8 and 9.

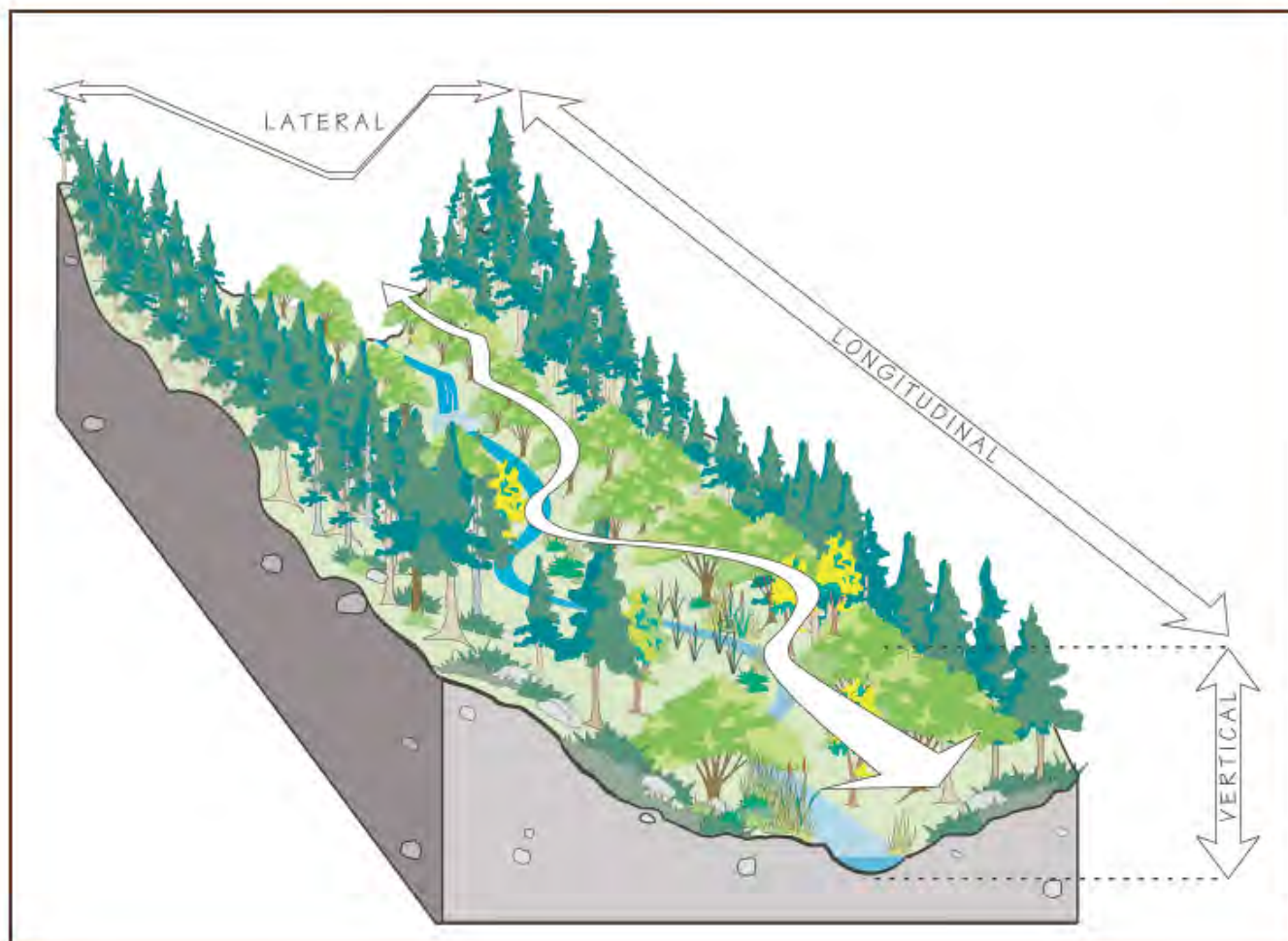

Figure 7—Identifying the riparian ecosystem.

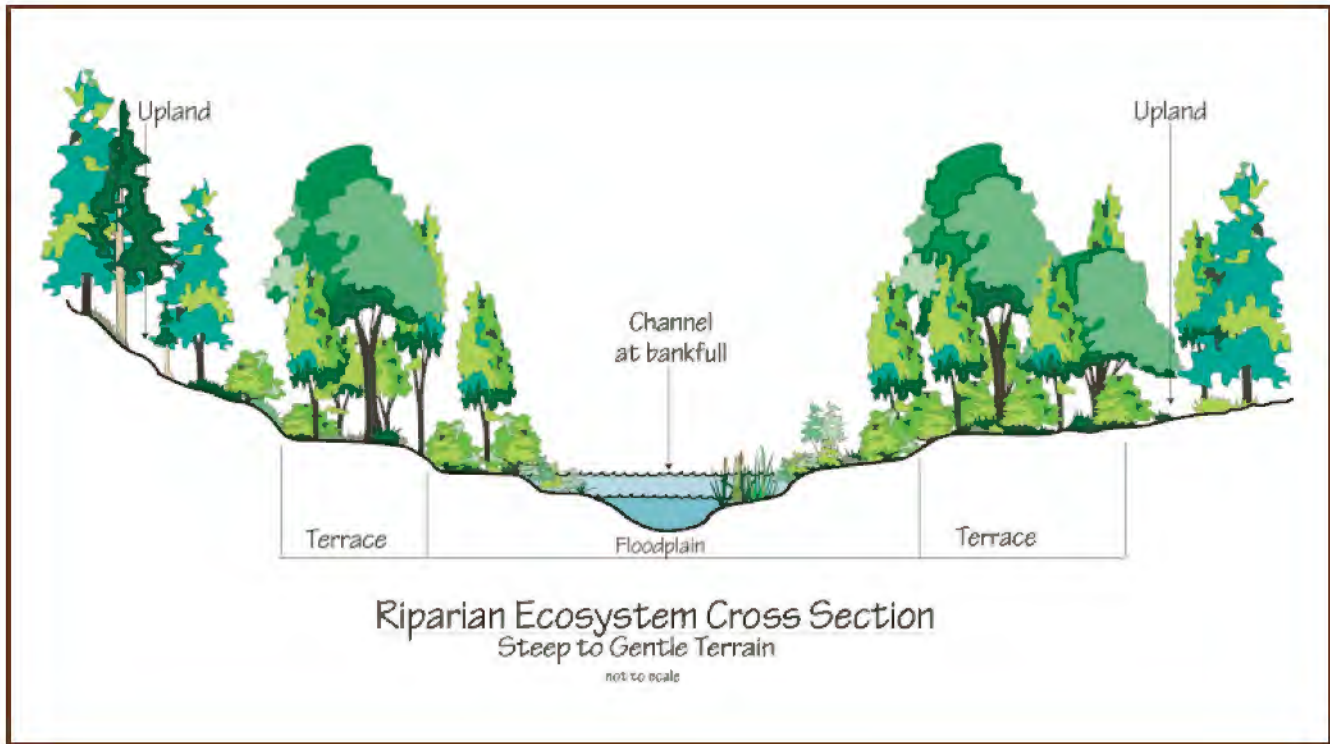

Figure 8—Riparian ecosystem cross section 1.

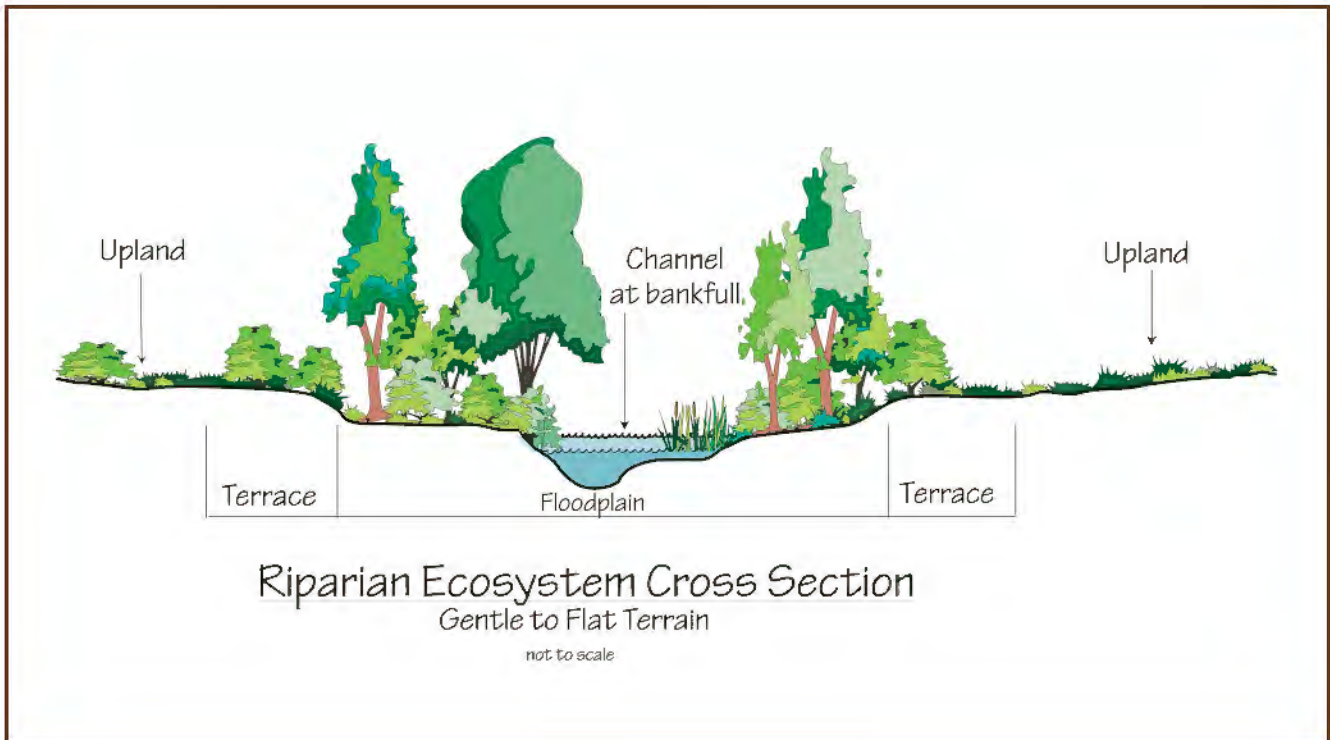

Figure 9—Riparian ecosystem cross section 2.

## Structure and Function

Riparian ecosystems provide the most important link between upland forests and aquatic habitats and have a unique array of functions. See figures 10 and 11.

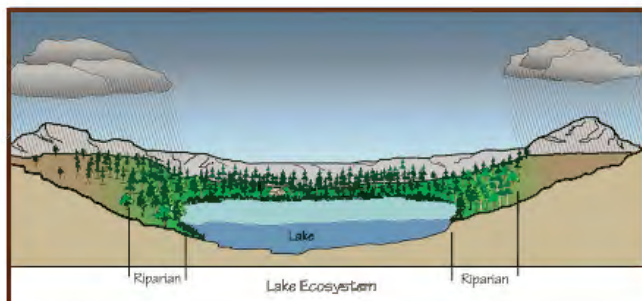

Figure 10—The area that drains into a lake is made up of one or more watersheds. The riparian ecosystem that surrounds a lake protects and promotes water quality, aquatic ecosystem health, and shore stability.

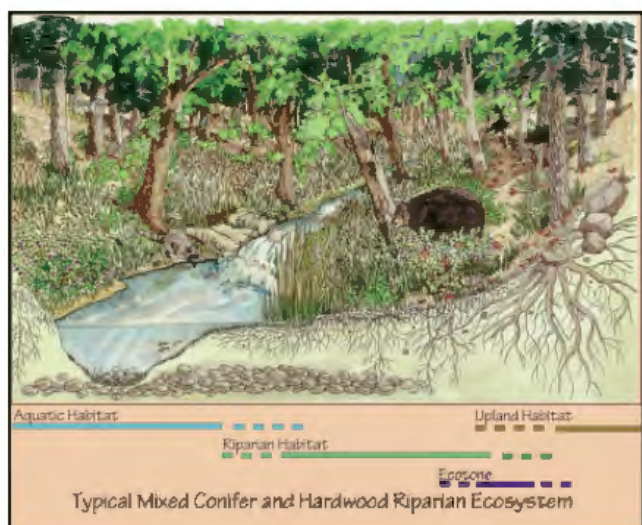

Figure 11—Typical mixed hardwood and conifer riparian ecosystem.

Canopies of large trees (structure) mesh to create a microclimate that functions to cool the riparian ecosystem, lower water temperatures, and shelter wet areas. In the absence of trees, low-growing plants and grasses provide shade as do undercut banks. See figure 12. Canopies of riparian forests produce particulate organic matter, primarily leaf litter, which is an important energy base for replenishing soil nutrients and aquatic food webs.

Palik and others (2000) found that one-third of leaf litter in streams originates from more than 30 meters away. The plant structure (standing and dead and down) of riparian vegetation, leaf litter, and uneven ground captures sediment and slows and detains

runoff and overland flow, providing storage and infiltration areas. See figure 13.



Figure 12—In this example, alders form a canopy over the stream.



Figure 13—Live and dead plant materials contribute to structure and function.

Plants with flexible stems and rhizomatous root systems lie flat against the ground as floodwaters wash over them, shielding the ground from erosion. These plants, upright shrubs, and tree species also slow waterflow and encourage sediment deposition.

Root systems and soil organisms create an interwoven structure that holds soils together, stabilizing streambanks. See figure 14. They catch and hold pollutants, use phosphates adhering to the soil and sediment particles deposited by runoff or floodwater, and hold harmful or toxic substances in place by minimizing soil movement (Ministry 1994).



Figure 14—Healthy soil is essential for plant growth and vice versa.

Litter and standing biomass are also necessary for soil regeneration. Without the cycle of litter and biodegrading, flooding, and plant growth, soil would not be replenished. Without soil, plants cannot grow; without plants, the soil is washed away. When soil is impaired or the topsoil is threatened, plants are less plentiful, have smaller basal areas, and have more space between them (Griggs and Stanley 2000). Such poor vegetation cover leaves the soil even more exposed to raindrop impact, sheet runoff, and erosion. As little or no moisture is held in the ground, the water table drops, water quality suffers, and fewer plants survive. Stream surface flows may decrease or cease.

Large woody debris (LWD) affects the configuration of a stream by diverting waterflow and forming pools. Debris helps regulate storage of sediment and particulate organic matter, and provides aquatic habitat (Murphy 1995). LWD also affects lakeshores by providing aquatic habitat and by forming natural

revetments that shelter the shore, causing beaches to form.

LWD is generated from several sources. See figures 15 and 16. Murphy and Koski (1989) suggest that as much as 50 percent of LWD originates from within 1 meter of the stream. In another study, Murphy indicates that a 30-meter, uncut riparian buffer zone is needed to maintain long-term LWD input (Murphy 1995). In mature and old growth forests in Oregon and Washington, for example, LWD is generated from within 20 meters of the stream (Dolloff 1994).



Figure 15—LWD in a stream.



Figure 16—LWD in a river.

In arid climates, woody debris may be carried from nearby mountains or be generated locally by native shrubs and sporadic stands of trees such as cottonwood or green ash. Debris catches on and piles up against rocks or outcrops.

Flood plains, another important part of riparian ecosystems, trap sediment and particulate organic matter outside the active channel during overbank flows (Swanson and others 1982; Harmon and others 1986, as seen in Gregory and others 1991). See figure 17. Riparian ecosystems regulate not only the movement of water between terrestrial and aquatic ecosystems, but also the movement of nutrients, sediments, and particulate organic matter over flood plains. Riparian vegetation on active flood plains is created by, adapted to, and rejuvenated by flooding. Even-aged stands reflect sporadic natural flooding events that periodically remove trees and shrubs.

“Non-flood plain forests [the riparian ecosystem on terraces and slopes beyond the active flood plain and surrounding lakes and open-water wetlands] trap sediment in overland flows before they enter the aquatic system. Tree boles, coarse woody debris, herbaceous vegetation, and litter all trap sediment in overland flow” (Palik and others 1998).



Figure 17—Flood plain.



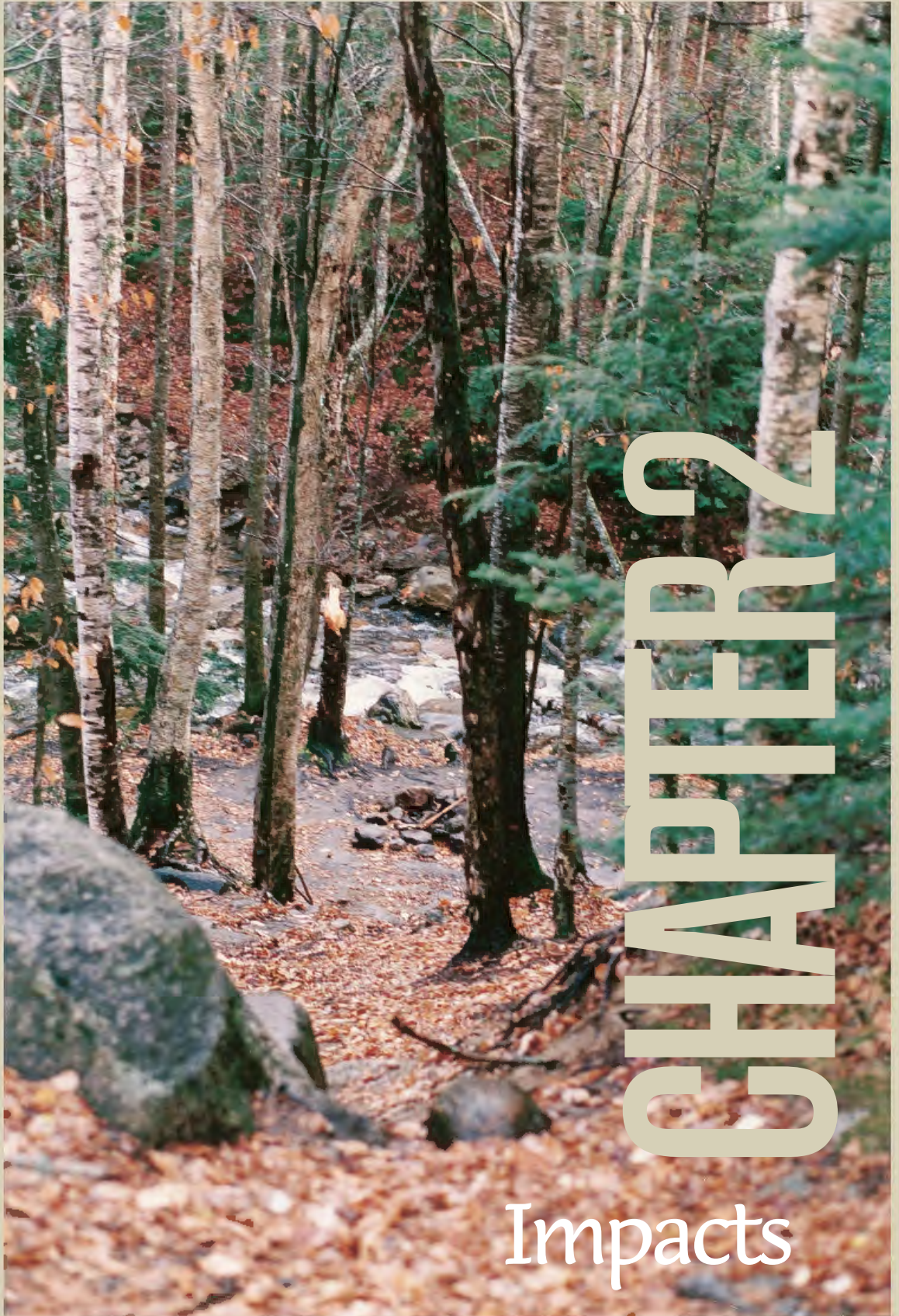

# CHAPTER 2

Impacts

## IMPACTS

Traditional management and engineering practices, coupled with increases in developed and dispersed recreation use, are cumulatively producing a range of effects from damaging to devastating on many riparian ecosystems.

### Traditional Design

Traditionally, designers and engineers have focused on providing recreation experiences through infrastructure and access with little regard for the consequences to natural systems, such as flood plains and riparian forests, and effects on wildlife. They developed sites primarily with regard to how visitors would benefit. See figure 18. The design process did not include a holistic scientific approach with a goal of sustaining riparian and aquatic structures and functions while allowing human use. See figure 19.



Figure 18—This area was filled to build a parking lot (flat area in upper right) and the bank was stabilized using riprap.

Figure 19—This well-used wooden structure was built to facilitate visitors dragging motorboats from one lake to another. Although this was a naturally occurring low area, it was altered when the structure was built; the banks were denuded and not replanted. They continue to erode. As visitors tie their boats to vegetation, they trample the bank, causing more erosion and damaging the riparian ecosystem.

In many cases what made a site attractive was ruined by the development. Designers and engineers overlooked detrimental effects of buildings, parking lots, and roads on riparian ecosystems. For example, they often cut off



flood plains from their streams and lakes by roads, trails, and parking areas. By design, they removed vegetation critical to the health of riparian ecosystems. In the process, wildlife habitat was lost (Knight and Gutzwiller 1995).

**Existing Sites**

In existing developed recreation sites, overuse and mismanagement also contribute to loss of valuable riparian resources. In many campgrounds and picnic areas, individual units become larger as visitors trample edge vegetation and trim branches. Units may serve more people than they were designed to accommodate. Visitors arrive with more and more recreational equipment (separate sleeping and eating tents) to use while camping, expanding campsite boundaries, trampling vegetation, compacting soils, and increasing the potential for runoff. See figure 20.



Figure 20—Many sites were designed for one car and a single tent. Camping habits have changed. It is not uncommon to see two tents at one site, or a recreational vehicle, and other amenities such as hammocks and tiki torches. Trampled vegetation and soil compaction are evident. This site is on the edge of a lake.

The pursuit of shrubs and saplings for firewood, hiking sticks, and so on causes considerable damage. Visitors trample the ground cover and saplings. For example, at a forest campground in Michigan where a portion of the campground had been closed, McEwen and Tocher (1976) found 76 saplings per acre in the open section of the campground and 338 saplings per acre in the closed section. Trampling was the cause for the low number of saplings in the open section (Manning 1979). This condition skews the age

distribution of plants and affects soil and wildlife, that is, it affects the ecosystem.

Recreation impacts are at nodes (gathering points such as campgrounds, trail heads, and rest spots) and along travel routes (Ward and Berg 1973, as seen in Manning 1979). These impacted areas have a tendency to expand over time. Visitors create their own trails (social trails) between companion units or as short cuts to certain attractions. These expansions disturb or fragment riparian vegetation and interior habitats. See figures 21, 22, 23, and 24.



Figure 21—On this social trail, plants are trampled and soil compacted.



Figure 22—This site is becoming larger and larger. There are no site boundaries and the entry is quite wide. A table is just barely visible behind the tree on the left. The grill seems to be a great distance from the table.



Figure 23—This user-made boardwalk, leading from a lake to developed campsites, is a hazard and an intrusion into riparian vegetation.



Figure 24—Riprap, in place of riparian vegetation, alongside a trampled, compacted streambank at a developed picnic site. Alder trees grow at the base of a riprap-covered bank.

### Dispersed Use

Similar damage patterns occur at dispersed-use areas. All dispersed-use areas are minimally managed for recreation but are specifically managed for timber, game habitat, grazing, or other specific resource use. Some areas share grazing and camping, which compounds the impacts to riparian ecosystems. Both activities can lead to trampled vegetation, soil compaction, and destabilized streambanks and shorelines.

Trail use is dispersed-use recreation. Several studies have documented trail erosion in certain soil types to be 1 inch per year in depth and 1 inch per year in width (Katchledge and Leonard 1970, Whitson 1974, and Burden and Randerson 1972, as seen in Manning 1979).

Many of these dispersed-use areas are so popular that visitors repeatedly return to the same spots, developing “improvements” and creating, in essence, developed sites without U.S. Department of Agriculture (USDA) Forest Service-provided amenities and management. Visitors fashion their own camp tables, stools, and privies out of adjacent trees and other nearby natural features. See figures 25, 26, and 27. Heavily frequented dispersed-use sites that lack adequate toilet facilities pose a pollution problem because of improperly disposed-of human feces. (A study in Montana showed that the “cat hole” method

of burying human feces was ineffective; *Salmonella typhimurium* survived through a summer and a winter.) Improperly disposed-of waste is exposed to surface runoff. Pathogens that can cause human diseases end up in streams and lakes and eventually in drinking water supplies (Cole 2000). New visitors attracted to these seemingly developed sites increase impacts upon the sites. Visitors who prefer undeveloped sites go elsewhere and open new areas. See figure 28.



Figure 25—Excessive dispersed use has left the ground bare, soil compacted, and the banks eroding.



Figure 26—Visitors carved steps into the bank of an incised stream.



Figure 27—Toilet seat and box frame are actually in the stream.



Figure 28—The dispersed site is at the river's edge; the ground is compacted by overuse. A broken-off tree is visible. When this area floods in the spring, there is little undergrowth and dead and down material to protect the topsoil from washing away. This is one of several dispersed sites along this stretch of river.

On the Angeles National Forest, compounded wear and boundary extensions are apparent. Every major canyon of the forest empties into Los Angeles County, which has an estimated population of 9.5 million people. (Sixteen million people live in the Los Angeles/Orange/Riverside County area.) Hundreds of persons congregate at dispersed-use sites along shallow rivers and streams, most of which are no wider than 12 feet.

Use in San Gabriel Canyon is excessive. See figures 29, 30, and 31. The riparian ecosystem averages a width of 200 feet. In one 200-yard-long section, more than 200 persons can be counted on hot weekday afternoons, May through October. Weekend use is even higher. The 10-mile-long canyon receives more than 20,000 visitors on any given Sunday during the warm months. District personnel report that, because of soil compaction, the trees are dying, their canopies are deteriorating, and they will not reach maturity. As the canopy thins, the water temperature increases. Little opportunity exists for regeneration of tree and understory growth. The river is episodically very turbid from erosion during spring runoff/flows. Increased sediment load is also caused by visitors walking in the river and stirring up the bottom, and by dust settling on the water from banks denuded by overzealous and careless visitors (Duffy 2001).



Figure 29—A typical group outing in San Gabriel Canyon with hammock, shade structure, water play toys, coolers, and trash.



Figure 30—Highway parking from the air. The stream is to the bottom (San Gabriel Canyon)



Figure 31—Parking at ground level. (San Gabriel Canyon)

At the west fork of the San Gabriel River, which supports native trout, most visitors use the first quarter mile of the river from the road. As a result, most fish are displaced from this high-use area but are plentiful upstream.

Technological improvements in motorized vehicles have also accelerated and intensified the impacts to riparian ecosystems. More powerful off-highway vehicles (OHVs) have allowed visitors easier access to more remote forest areas. For example, the Newport Ranger District on the Colville National Forest in Washington (figure 32), the Lake George Ranger District on the Ocala National Forest in Florida

(figure 33), and the Yakutat Ranger District on the Tongass-Chatham Area National Forest in Alaska have at least two things in common: they have wetlands (that is, meadows and muskegs), and they are losing the wetlands to OHV use.



Figure 32—Mud and tracks on the Colville National Forest.



Figure 33—OHV traffic has run amuck through this wetland on the Ocala National Forest.

These powerful, versatile OHVs churn and tear up the landscape. Users make their own trails, and in drier seasons, camp on wetlands. Vehicle tire ruts destroy aquatic habitat and structural components of the wetlands ecosystem in Florida, and in Alaska, interrupt natural migration patterns for salmon and other fish species on the Yakutat.

At 10-Mile Bog on the Yakutat Ranger District, OHVs have cut one trail down the main stream, leaving multiple ruts in several areas through the bog, which has several salmon-spawning streams. See figure 34. Once hatched, the salmon fry grow in the shallow protected streams before traveling to the ocean. If the fry swim into the tire ruts (many of which are the depth of the stream), they can be cut off from the main channel, become trapped, and die as the water level drops and the tire tracks dry out.



Figure 34—Multiple ATV tracks on 10-mile Bog. (This situation was remedied by providing an ATV trail on high, dry ground and by reestablishing the stream edges using coconut logs, thus blocking access to the ruts.)



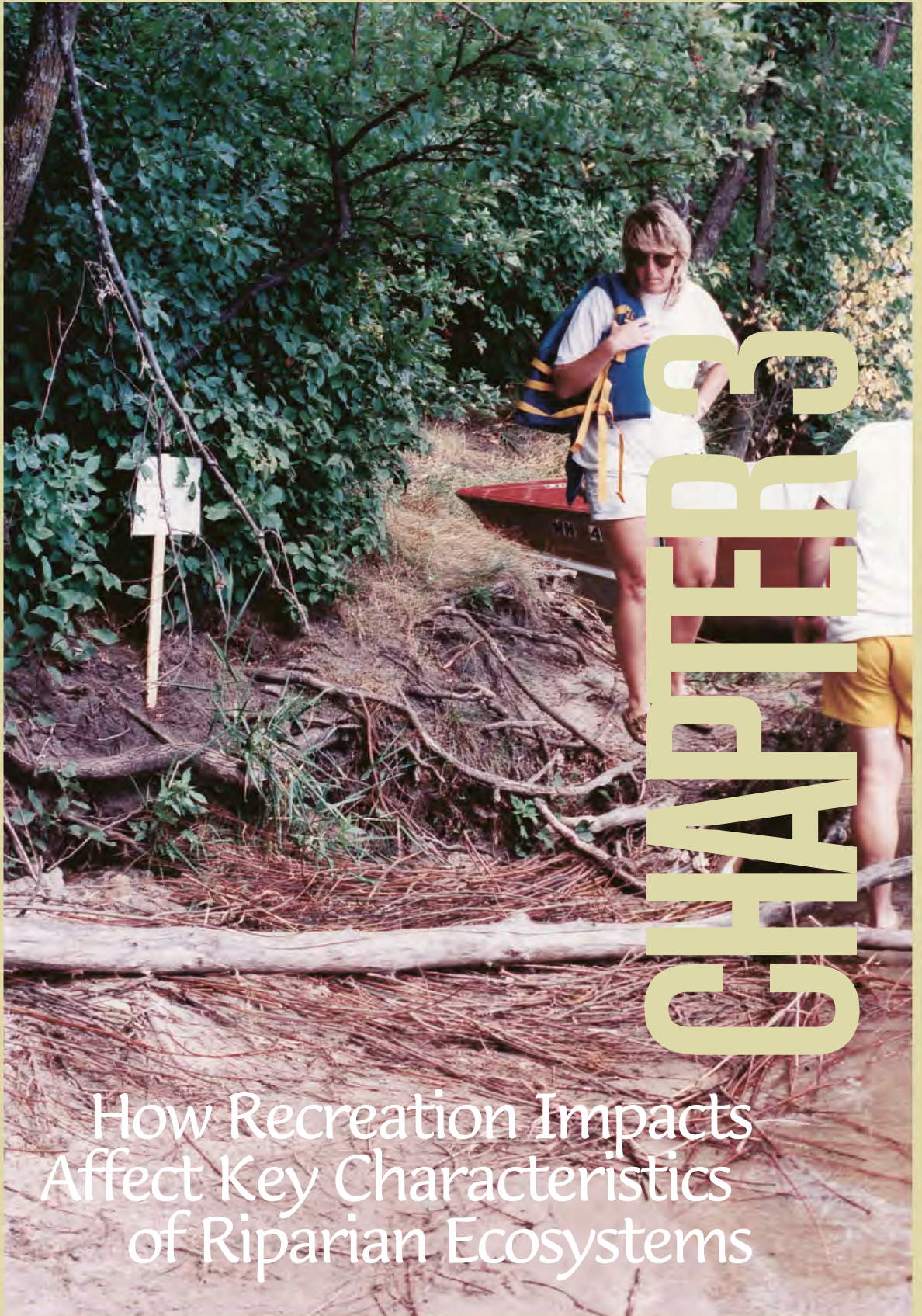

# CHAPTER 3

How Recreation Impacts  
Affect Key Characteristics  
of Riparian Ecosystems

## HOW RECREATION IMPACTS AFFECT KEY CHARACTERISTICS OF RIPARIAN ECOSYSTEMS

The following paragraphs discuss recreation impacts to soil, plant species diversity, aquatic life, and wildlife.

### Soil Moisture

Runoff and percolation patterns of natural areas within a developed site are often changed by recreation development. Abnormally low levels of soil moisture in certain areas and higher-than-normal levels in others, cause plant stress. Roads that are elevated above the natural grade can cut off water bodies from flood plains. Roads adjacent to streams or meadows act as levees, preventing natural flooding or redirecting surface flow movement. Improperly constructed roads may block or reduce water that normally seeps or flows from the upslope to the stream, thus reducing flow to the stream, drying out the soil, and reducing vegetation; that is, negatively affects the riparian ecosystem. Roads constructed across streams or meadows can dam water and drown vegetation on one side, and dry out vegetation on the other side. See figures 35a and 35b.



Figure 35a—Upstream. After this dirt road was built, trees on both sides died. Trees on the upstream side died from too much water and those on the downstream side from too little water.



Figure 35b—Downstream.

Pavement, structures, vehicle use, and barren soils that result from overuse introduce more heat into the riparian ecosystem. Added heat dries the ground, weakens plants, and warms the water, which can have a negative effect on aquatic species. Heat can lead to less and less ground water availability for plants and for recharging streams and lakes during dry seasons and, ultimately, to aquatic and riparian habitat loss.

### Soil and Vegetation Diversity

Human foot traffic in concentrated areas can be as destructive as cattle traffic. Horseback riding and vehicle use, including cars, trucks, OHVs, trailers, and mountain bicycles, also contribute to soil compaction. See figure 36. The potential for damage increases from human to pack stock to motorized vehicles. “A controlled experiment on a sloping mountain grassland (*Poa pratensis* and *Festuca idahoensis*) in Montana found that 200 motorcycle passes removed twice as much vegetation as the same number of passes by a horse and nine times as much vegetation as 200 hiker passes” (Weaver and Dale 1978). Motorized recreation causes “extreme and deeper soil compaction... [and] are (sic) significant agents of erosion” (Cole as quoted in Alexander and Fairbridge 1999).





Figure 36—Damage caused by OHV use on the Ocala National Forest.

Soil compaction begins with trampling and treading, which includes crushing, bruising, breaking, and uprooting vegetation. See figure 37. Manning (1979) lists a seven-step soil impact cycle that includes “the scuffing away of leaf litter and other organic material on the soil surface. Soil litter cover is pulverized when exposed to trampling and is then easily blown or washed away. ... Ordinarily, this surface material serves to cushion layers of soil from trampling and absorbs large amounts of rainfall. Washing [surface runoff] of this surface exacerbates the problems of compaction and runoff, and the cycle continues in this manner” (Manning 1979).

Loss of vegetative cover, duff cover, and the subsequent loss of the organic horizon or topsoil by flooding and/or by continued human disturbance, such as trampling, exposes mineral soils. Furthermore, trampling frequently increases light intensities and temperatures, both above and below the soil surface (Cole as quoted in Alexander and Fairbridge 1999). Increased light intensity and temperature disturb the physical, biological, and chemical characteristics of the soil, resulting in lower productivity and lower water infiltration rates. See figures 38, 39, 40, 41, and 42.



Figure 37—This user-made ATV trail detours around a locked gate. It crosses one of the few salmon-spawning streams in the area and creates edges in the riparian forest.



Figure 38—Use at this dispersed site has isolated young trees. The stump of one is visible.



Figure 39—An ever-expanding dispersed site.



Figure 40—This Alaskan trail is in a rain forest, so it is always wet. Hikers walk on the edges of the trail, trampling plants, ever widening the trail, and exacerbating the problems. The trail is also compacted, muddy, and rutted.



Figure 41—This dispersed parking lot is growing because there are no boundaries. The vegetation is becoming more and more trampled. Angler access to the river has caused a large chunk to erode. High flows eventually will cause further erosion at this vulnerable spot.



Figure 42—Windfall Lake Trailhead. There is no defined boundary and therefore no edge to this parking area. Parking areas with no boundaries expand when they become crowded or as drivers seek to park under shade.

Pore spaces in the soil aerate roots and hold water. Compaction packs the soil particles closer together and eliminates pore spaces (Cole as quoted in Alexander and Fairbridge 1999). Compaction allows less infiltration, which leads to lower soil moisture content, fewer seeds germinating, and lower rates of seedling survival. “Young and Gilmore (1976) found that even when relatively high levels of organic matter and soil nutrients were present, they may be unavailable, perhaps due to high soil compaction and low soil moisture and oxygen content” (Manning 1979). Reduced or eliminated pore space also weakens plant vigor and reduces root penetration. Compaction also decreases soil-building plant litter and the number of arthropods, earthworms, and beneficial bacteria and fungi present (Ferren and St. John 2000).

The following diagram illustrates the cumulative effects caused by trampling and treading as vegetation is weakened and soil is compacted. See figure 43.

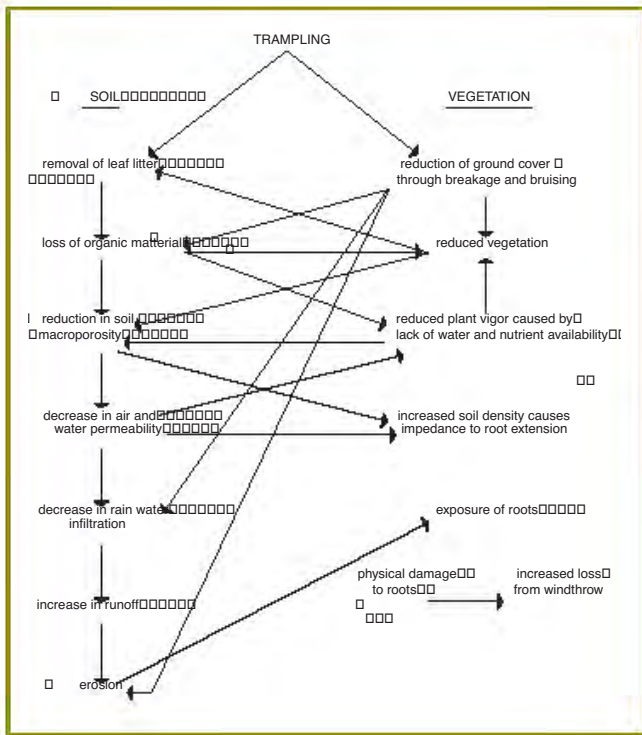

Figure 43–Soil/vegetation impact diagram (Manning 1979).

### Habitat Edges

The edge of a stream or the transition from riparian ecosystem to upland forest creates a natural edge. See figure 44. Plant type and density vary on edges as compared to the interior, an area away from an edge. Trails and ever-expanding camp and picnic units or staging areas increase the exposure of the interior by creating new edges. Roads create their own edge effects and their impacts can be great. Longer roads potentially have a greater impact on the nearby environment. These edges are more open to disturbance by humans and to the influx of nonnative species, both plant and animal, by “...providing pathways for travel and by having newly disturbed areas to colonize in” (Falk 2000). They encourage nonnative wildlife species at the expense of native species that require interior habitat for nesting and shelter. The balance shifts, skewing the ecology.



Figure 44–Stream edges.

### Aquatic Ecosystems

Most aquatic ecosystems depend on adjacent riparian ecosystems for food, shelter, cover, and for maintaining proper water temperature. See figure 45. When riparian ecosystems lose structure, opportunities for erosion and sediment deposition into water bodies increase. See figure 46. Vehicle crossings and pollution from motorized equipment such as boats, jet skis, and gasoline generators used for recreational in-stream mining also impact the aquatic ecosystems.



Figure 45—Aquatic ecosystem. Woody debris is present; trees and shrubs overhang the bank, creating a microclimate that helps keep the water temperature appropriate for that stream; insects on the vegetation drop into the water to feed the fish; and the banks are stabilized by the vegetation.



Figure 46—Trampling and boat wakes are eroding this lakeshore.

Fish productivity is intricately linked to riparian plant composition. Plants provide shade to maintain proper water temperature and shelter fish. Many aquatic insect species spend a part of their life cycles on riparian vegetation before dropping into the water to be eaten by fish and other aquatic species. When riparian vegetation is missing from the water's edge, much less food is available for fish and other aquatic species.

### Wildlife

Complex structure and function, species diversity, and age composition of riparian habitats are essential elements for sustaining healthy wildlife populations (McKee and others 1996). The presence of water and rich plant diversity encourages animal diversity. Less and/or weakened vegetation means less available vegetative matter (structure) for animals and microbes to use for food and shelter (Knight and Gutzwiller 1995). Wildlife also affects plant diversity because it pollinates plants and transports seed. See figure 47.



Figure 47—Mountain goats.

The presence of humans, their paraphernalia, and their machines affects the health of the riparian ecosystem and the welfare of wildlife. Knight and Cole cite four main ways that humans impact wildlife: (1) exploitation (hunting, trapping, collection), (2) disturbance (intentional or not; for example, wildlife viewing, hiking through an animal's territory), (3) habitat modification, and (4) pollution (Knight and Gutzwiller 1995). See figure 48.



Figure 48—Partially hiding used toilet paper under a rock is not only unsightly and unsanitary; it could also attract and sicken wildlife. It may signify ignorance about proper waste disposal procedures and overuse of an area.

“Long-term effects of repeated disturbances range from an increase in the population of one or more species tolerant of human activities to the extirpation of one or more populations” (Stanley 2000). These disturbances affect the diversity and dynamics of the ecosystem. Even seemingly innocuous activities such as picnicking and wildlife viewing can have long-lasting effects on wildlife. Encounters increase the metabolism of animals, causing them to burn more calories and expend more energy (Stanley 2000).

Although the human impact on wildlife is not well researched, some data exists. For instance, wildlife viewing or photography can cause animals to change their normal behaviors. Steve Cain, senior wildlife biologist at Grand Teton National Park, notes that “encounters with humans increase stress on animals that are already struggling to survive. As the fight-or-flight instinct kicks in, some animals may flounder through deep, heavy snow to get away. Even if an animal sits still in an encounter with humans, its metabolism is probably racing and its energy stores are rapidly declining.

Biologists have quantified this effect using heart-rate monitors. By some estimates, an ungulate may expend a week’s worth of energy during a single encounter with a human” (Berwyn 2001).

Other examples of data concerning human impact on wildlife are as follows:

- ◆ Winter recreation can be more detrimental than warm-season recreation for wildlife because animals are weak and stressed in the winter. Compacted snow is deadly for small mammals, such as voles. For example, in meadows snow forms an insulating layer that keeps the ground warm enough for animals to survive the winter. When snow is compacted, it loses its insulating value and causes the ground temperature to drop and the animals to die. Snowmobiles are particularly damaging to frozen shrubby vegetation, which is brittle and snaps off when run over. (Cole as quoted in Alexander and Fairbridge 1999). Winter recreation can cause loss of habitat and food.
- ◆ Klein (1993) found that photographers exited their vehicles and moved closer to wildlife more frequently than other wildlife viewers, causing unforeseen problems such as one that Klein (MacIvor and others 1990) points out: “Predators learn to follow the human scent trails to nest sites” where humans had ventured (Knight and Gutzwiller 1995).
- ◆ Yarmoloy and others (1988) noted that radio-collared mule deer altered their feeding and spatial-use patterns and showed a loss in reproductivity a year following harassment with all-terrain vehicles (ATVs) (Knight and Gutzwiller 1995).

Bears and their habitat are affected by human behaviors, such as recreational-use patterns and habits. Bears have learned to associate humans and camping with food. Rather than spend their time foraging, as nature would have it, they seek out improperly stored food caches for easy meals. As a result, nuisance bears may have to be killed or be relocated from their territories. They and other animals also are susceptible to human disease and can become ill from exposure to trash and food left behind by humans (Cole as quoted in Alexander and Fairbridge 1999). See figure 49.



Figure 49—This campfire is full of nonbiodegradable trash that should have been packed out. It may be a hazard to wildlife.

### **Impact Matrix**

See appendix A for a matrix that summarizes potential impacts of recreation facilities and activities to riparian forests.





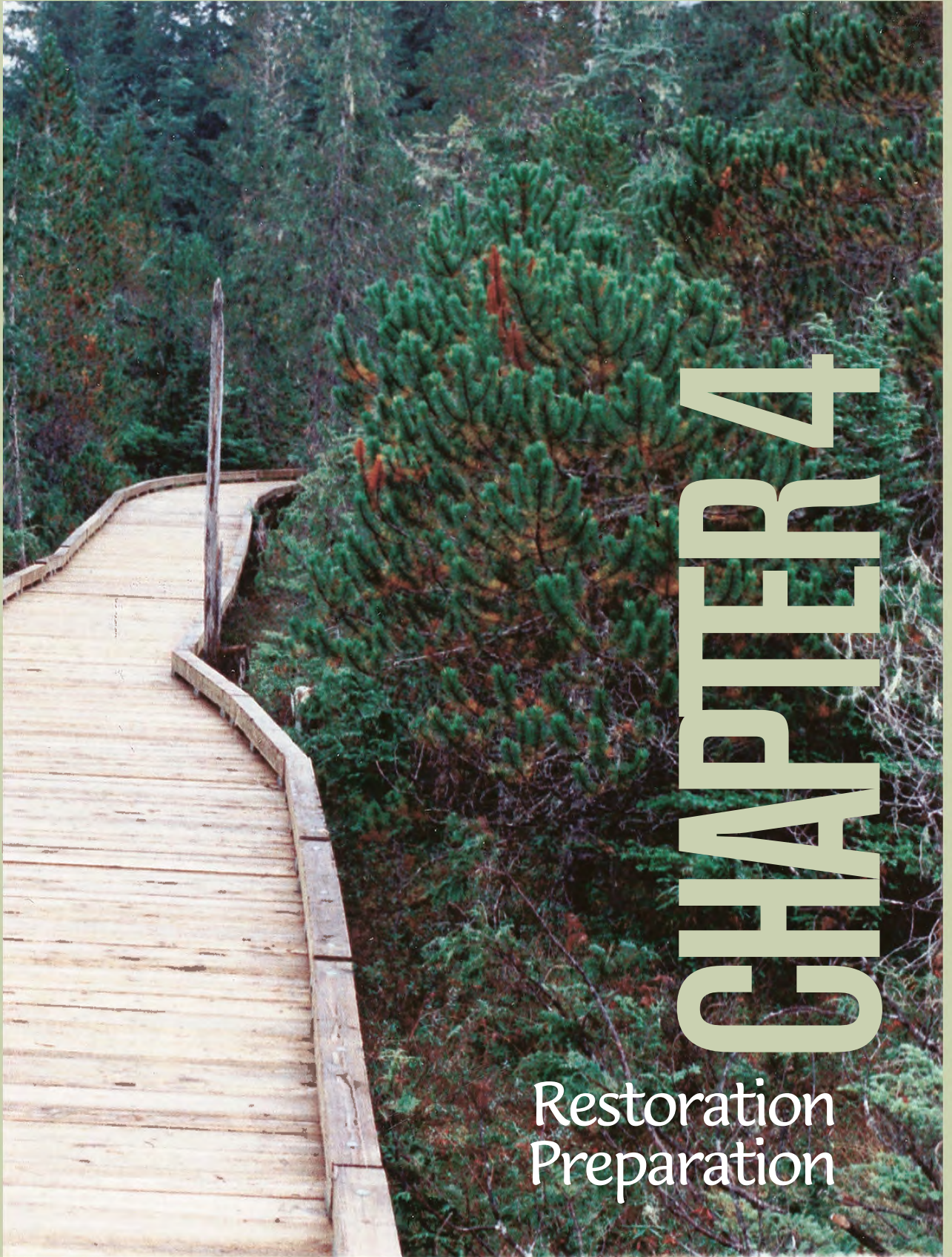

# CHAPTER 4

Restoration  
Preparation

## RESTORATION PREPARATION

The goal of riparian restoration is to set in motion a process that enables natural ecological processes to reestablish themselves and to continue. The essence of riparian restoration is working with nature rather than trying to change or control it. To accomplish this goal requires being acutely aware of the area's natural characteristics, its natural functional and structural elements, including but not limited to climate, soils, weather patterns, hydrology, plants and wildlife, and also being aware of socioeconomic use patterns.

Good planning will make or break any project, especially one as complicated as a restoration project. Planning must encompass any aspects, whether grand or minute, that might impact the site.

An interdisciplinary (ID) team is necessary for a riparian restoration project. It is essential to clearly delineate riparian characteristics through science-based field assessments. The team must gain a thorough understanding of the restoration site, its associated problems, and of how these problems are affecting the site and other natural processes in the watershed. The team also needs to know how current and proposed recreational activities might affect the site and surrounding areas.

When assessing the restoration site (sometimes called a site analysis), the ID team should address the assessment holistically, assessing upstream and downstream conditions, lateral and vertical conditions, conditions of areas surrounding lakes and other water bodies, and their connections to the restoration site. The team should conduct initial planning assessment at a broad watershed scale and graduate to collecting information at a project-specific scale. Such assessments will help determine whether a problem is unique to the site or symptomatic of other problems in the watershed. Planners, designers, and other members of the ID team should seek long-term solutions to the problem rather than using a "quick-fix" that treats only symptoms.

### Understand Existing Conditions

In the early stages of project planning, a field assessment conducted by a team of specialists can clearly identify the riparian ecosystem and the outside influences that contribute to its health or infirmity. This assessment clearly defines which ecological functions and processes must remain undisturbed during and after any potential construction and/or restoration projects. With this approach, protection of riparian structural and functional characteristics automatically becomes part of the planning, design, and construction processes.

To help understand the structure and function the site may have had, the ID team should use a reference site to compare, in the simplest of terms, a functioning, intact site with the project site. The reference site can be adjacent to the damaged site, a short distance away, in the same watershed, or in a different watershed with similar ecosystems. It needs to have characteristics similar to the project site, such as soil type, aspect, topography, geology, stream patterns and profile, weather patterns on lakes, and climate.

To analyze the reference and restoration sites for differences and commonalities, the ID team should consider the following factors:

#### 1. Historical records

- ◆ Historical written records and photographs to the present for analyzing social and economic trends and use patterns, including indigenous peoples, pioneers, and settlers.
- ◆ Aerial photographs for comparing images from different decades or years.
- ◆ Climate data from Government land office surveys, old journals, dendrochronology (tree-ring analysis), pack rat middens, and palynology (pollen analysis).
- ◆ Topographical maps.
- ◆ Land-use patterns including farming, ranching, housing, and recreation.
- ◆ Proper Functioning Condition reports (DOI 1998).

## 2. Adjacent communities and activities

- ◆ Adjacent conditions of upland and riparian habitats and how their conditions may be affecting the reference and restoration sites.
- ◆ Hydrologic responses, such as percolation tests and water storage differences between degraded and natural sites.
- ◆ Depth-to-dry-season water table, which may vary during the day, thus requiring readings at the same test sites morning, noon, and evening to determine water depth. (Water table depth profoundly influences the ability to restore riparian structure and function.)

## 3. Soils

- ◆ Site-specific soil survey to provide site productivity information such as nitrogen, calcium, and phosphorous content; percent of organic matter; and so on; physical properties (for engineering purposes); and water-holding capacities.
- ◆ Soil type variability across the site.
- ◆ Soil moisture variability across the site.

## 4. Hydrology

- ◆ Water quality to determine the presence of toxic chemicals, such as herbicide residues, aquatic macroinvertebrates, and periphytons (communities of microorganisms that are associated with various aquatic substrates).
- ◆ Stream and watershed health (Regional 1995; USDA FS 1989).
- ◆ Annual hydrograph.
- ◆ Flood regime—time-of-year of flooding, length of time of overbank flooding, and frequency of flooding.

## 5. Vegetation

The ID team should use transects of the reference site to inventory the benthic macroinvertebrates, vegetation species frequency (plant species composition), woody species density, and woody species age classes. The team should use references such as DOI BLM1992; USDA FS 1989; Bonham 1989; and Myers 1989.

- ◆ Canopy—coverage and health.
  - ◆ Root structure.
  - ◆ Characteristics such as old growth, even age, and so on.
  - ◆ Dead and downed material.
  - ◆ Litter.
  - ◆ Root zone functioning.
  - ◆ Plant composition—The ID team should note closely the plant variety differences at the water's edge or ecotone where the riparian ecosystem blends with the upland species as compared to the middle of the site and look for the ecotones within the riparian ecosystem. Plant species on terraces, which mark abandoned flood plains, will be different from those on flood plains because soil moisture in the terrace is probably lower than on the flood plains.
  - ◆ Visibility of species during only part of the year; for example, annuals.
  - ◆ Identity of all threatened and endangered species.
  - ◆ Habitat for specific animals—migratory and resident.
- ## 6. Wildlife
- ◆ Bird populations.
  - ◆ Identity of which birds customarily use the project site during breeding season, as a way to gauge riparian health. If birds are absent, the site may have been altered to an extent that makes it uninhabitable.
  - ◆ Identity of all threatened and endangered species and their habitat niches.
  - ◆ Identity of migratory and residential use.

In some areas of the country, it may be difficult to find a reference riparian ecosystem that has naturally occurring processes that support riparian structure and function. For instance, the native vegetation may have been removed for farming and then left fallow.

What grew back may not be native riparian vegetation, nor would it necessarily have a riparian structure to support ecosystem functions. Information gleaned from historical accounts, soil analysis, an adjacent watershed, and the flood regime would indicate what the land was capable of supporting. Local botanists and native plant societies can suggest appropriate plant selections to achieve ongoing ecosystem function.

### **Project Goals and Objectives**

The ID team should determine the project site's future condition (FC) based on its analysis. It should set the FC for what the project site is ideally capable of supporting. Forest plans generally have a broad FC, while a site's FC is specific.

To achieve the FC, the team should set project goals and objectives, which at a minimum should support the proper functioning conditions of the riparian and watershed ecosystems (Prichard 1998). A goal is a general broad statement of purpose and direction that supports or is an element of the FC. For example, a goal might be to restore natural riparian ecosystem processes to the site by reestablishing riparian function. Goals, which deal with distant timeframes, can be achieved but cannot be "done." Objectives, which are more immediate, are a series of steps or activities to be done that lead to the accomplishment of goals (Rieger and Traynor 1998). They are measurable.

The drawings in figures 50 and 51 show how to use a site analysis and good design to sustain riparian structure and function. The same principles are also useful in evaluating current conditions and/or restoring an existing site.



Figure 50-Site analysis.

# Site Inventory and Analysis

When workers survey a site, they should begin with a topographical map that identifies all natural features and how they work in the landscape. They should observe the following:

## Topography

Note contours of slopes and valleys, flat areas, and rock outcrops.

## Drainage

Note drainage patterns from upslope to downslope and across flat areas and their connections to the stream/lake/wetlands.

## Vegetation

Note upland species, species that make up transition (ecotone) areas, aquatic species, keystone species, and threatened and endangered species.

Note the placement and relationships of trees to shrubs and grass, and their relationships to topography and soil types.

Observe the tree canopy, how the light penetrates it, and where shadows (shade) are cast throughout the day. Note which areas are dense with vegetation, and which are open (microclimates).

Observe the way in which plant species function to hold the soil in place; replenish soil with nutrients; and supply food, shelter, and travel ways for wildlife.

Note offsite influences, such as land-use and man-made features that affect the health of the riparian and aquatic ecosystems.

## Weather

Note the prevailing weather patterns, annual rainfall and/or snowfall amounts, number of sunny days, prevailing wind patterns, and solar orientation/sun angles.

Observe where snow drifts from and to.

## Hydrology

Check historical records for flood regime. Find the channel bankfull level. Record the water temperature and analyze macroinvertebrate health.

Find out if there is a dam upstream and/or downstream of the site. Note reservoir high- and low-level readings over the life of the installation.

Do a Proper Functioning Condition survey. Note whether banks appear stable or are eroding or aggrading.

## Down-and-Dead Material

Note whether the ground is bare of debris or has layers of woody debris, leaf litter, and duff layer. Note any woody debris in the channel or lake.

## Soils

Note soil types and whether they are types that compact easily. If soils are disturbed, find the cause. Note erosion due to disturbances. Note wet soils.

## Wildlife

Note keystone and threatened and endangered species. Observe habitat characteristics that attract wildlife to the site. Name the resident and migratory animal species, including birds and fish that use the site.



Figure 51—Design Principles

## Project Design

After studying campgrounds, Orr (1971) found that “design is the second most important variable in relation to site deterioration” (Manning 1979). The design is based on the data gathered and on internal and external influences (social factors). Recreation-use planning is an integral part of site design. When a recreation facility is planned, habitat fragments are likely to be created. The ID team must understand the habitat needs of the resident and migratory wildlife and eliminate as many fragments as possible from the design. The team should consider relocating a facility out of the riparian ecosystem and providing planned access routes to the water and other attractions.

While recognizing that each restoration project is unique, the team should adhere to certain design principles:

- ◆ Design facilities to balance the benefits of access against the effects they will have on riparian processes; that is, structure and function.
- ◆ Use soil-survey information to help site recreation facilities on soils that are likely to be less susceptible to compaction and erosion and more productive and stable (Manning 1979).
- ◆ Use good design to substantially reduce and eliminate deterioration of ground cover and other plant life (function) on new or recovered sites. Install barriers and hardened or mulched paths, delineate camp and picnic sites, and install signs to indicate where forest visitors should or should not go and interpretive signs that explain why. See figures 52 and 53.



Figure 52—A hard surface defines this accessible camping unit.



Figure 53—Path is defined by a low fence and is covered in mulch. It is accessible and the mulch protects the soil.

- ◆ Leave native vegetation, whether alive or dead and down, on the site.
- ◆ Lessen negative impacts to the restoration site by addressing management and restoration of upslope and adjacent areas of influence.
- ◆ Consider fencing off a site, which is sometimes the best and most efficient restoration solution. See figure 54. Yosemite averages 90 to 95 percent compliance in keeping visitors out of restoration sites by using fences and informational signs. (See appendix E.) Fence installations encourage compliance. Cutting corners off potential restoration areas so that visitors can see their destination from the path encourages them to stay on the trails. (Fritzke 2001). See figure 55.



Figure 54—The fence blends with the forest, allowing views of the lake while protecting the riparian vegetation.



Figure 56—Cedars are very sensitive to hydrological changes. The cedars (at right foreground) died because of the road construction and because the subsequent compaction and settling of the roadbed changed the hydrologic regime. The water became impounded around the cedars and they drowned. Their deaths further impacted cedar regeneration because increased deer browsing makes regeneration difficult, if not impossible.

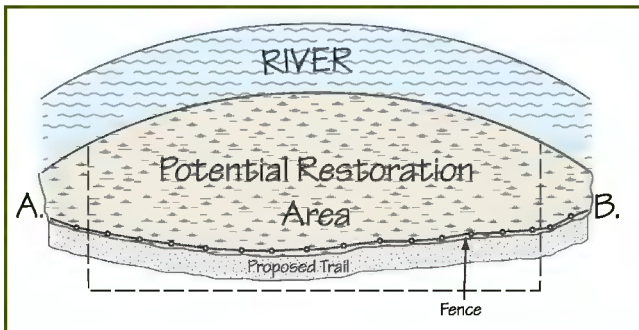

Figure 55—Restoration site with trail.

- ◆ Be aware of the hydrologic connections on the site and the effect that grade changes may have on them, and ultimately on the riparian ecosystem. For example, be sure flood plains remain functional. See figures 56 and 57.



Figure 57—Drainage patterns changed when a road was built across this meadow. The water can drain through only a few culverts, which concentrates the outflow and causes down cutting that has led to an incised stream.

- ◆ Determine whether the channel is stable. If it is not, determine whether it is incising or aggrading. (See appendix H for sources on channel stability.) If it is incising, the water table may be lowered, perhaps beyond the reach of most riparian plant roots. See figure 58.





Figure 58—Incised channel.

- ◆ Design functional elements of the riparian ecosystem, including reconnecting the site to its hydrologic regime, restoring the natural topography, and planting site-specific vegetation. See figures 59 and 60.

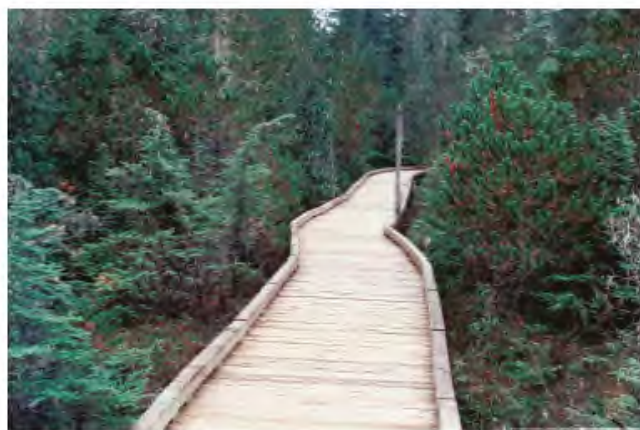

Figure 59—This boardwalk winds over and through a riparian ecosystem, allowing visitors to experience and yet not disturb its structure and function.



Figure 60—A side view of the boardwalk shows plant growth under the boardwalk.

- ◆ Understand the consequences of actions such as cutting and filling; removing vegetation; and placing and constructing facilities, roads, and trails. For instance, because of pollution potential, do not drain parking lots directly into water bodies. See figure 61.
- ◆ Understand which activities can be supported in the area and how they mesh with sustaining natural riparian processes. (See appendix A.) Plan for the separation of conflicting types of recreation. Design according to what visitors want to do, while protecting the resources. “For example, ... visitors want access to the river but this is inappropriate due to channel location (outside meander bend) so fencing and signs are installed to focus access to more appropriate sites both up and downstream” (Fritzke 2001).
- ◆ Plan paths to popular destinations such as restrooms, trash bins, other campsites, beaches, vista points, amphitheaters, trailheads, dispersed fishing and access points, and so on. Control where visitors go by using rustic wood fences (see appendix E); native rock; native thorny shrubs, vines, roses; and hardened paths. “Impacts can also be minimized by controlling the distribution and location of visitor use. Concentrating use and the resultant

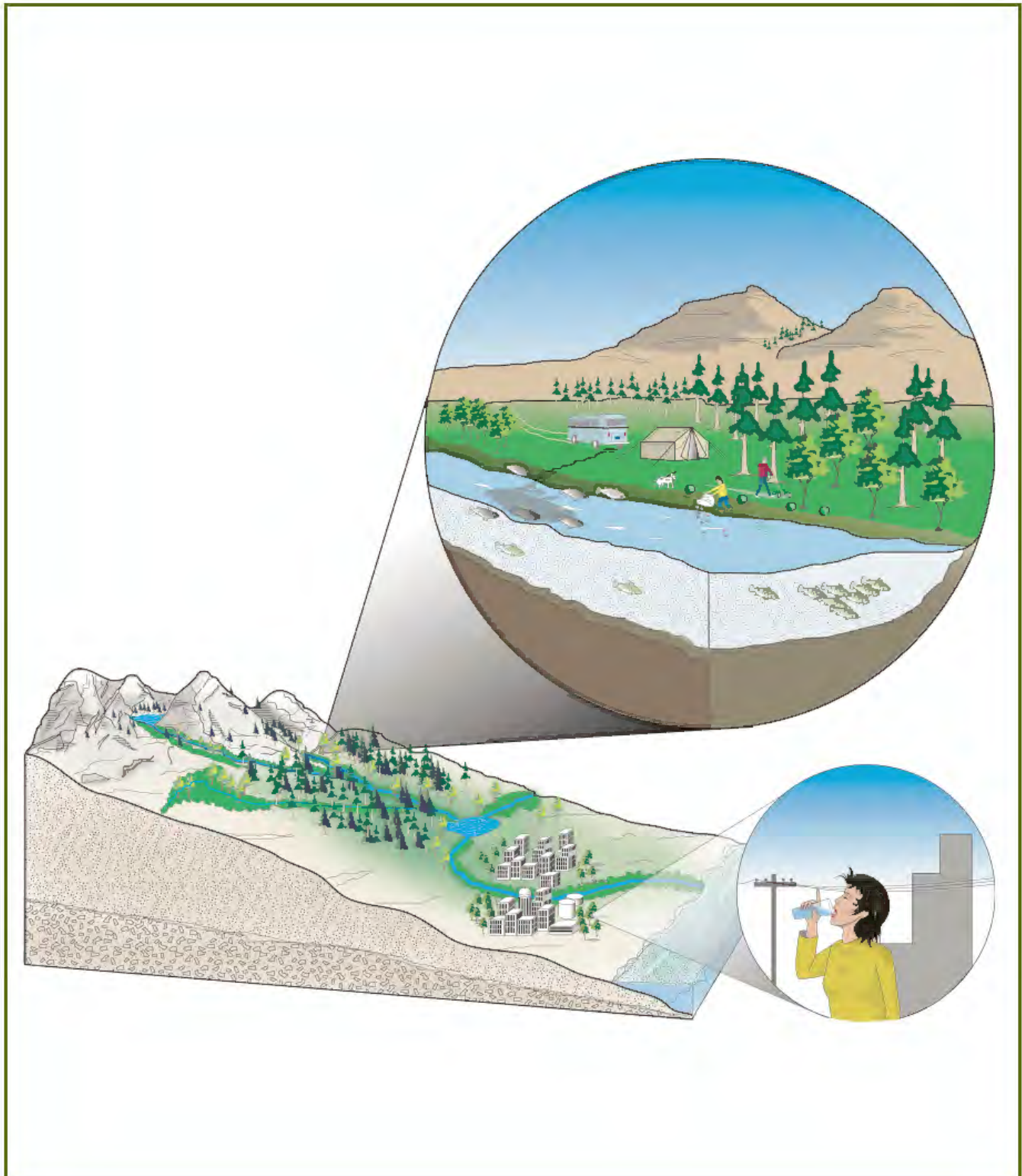

Figure 61—Actions upstream affect water quality downstream.

impacts in a few places will leave most of the area relatively undisturbed” (Cole as quoted in Alexander and Fairbridge 1999). See figures 62, 63, 64, 65, and 66.



Figure 62—A delineated path shows visitors where to go.



Figure 63—This trail allows water to flow through it, preserving the wetland and providing a dry walking surface.



Figure 64—Visitors using this water pump stay on the pavement and off the vegetation.



Figure 65—A fenced and signed path in Florida. The path leads to a beach and keeps visitors off the riparian vegetation.



Figure 66—A fenced path leads to a defined picnic area.

- ◆ Ensure that high-use areas, such as campground trails, roads, and campsites, are inherently durable or have hardened surfaces to prevent deterioration (Cole as quoted in Alexander and Fairbridge 1999). See figure 67.



Figure 67—Site cover material is 1/4 inch and less crushed limestone for accessibility. Each campsite area is framed in timber.

- ◆ Provide education through talks, signs, brochures, and Forest Service personnel. Such efforts are key to keeping visitors informed and ensuring their cooperation in behaving responsibly. See figure 68.

River rafters, canoeists, kayakers, innertubers, picnickers, trail users, snowmobilers, and other visitors need to know the consequences of their actions and what they can do to leave the least imprint on the land. Mandatory ranger talks to users before allowing them on the Colorado River in the Grand Canyon and on the Middle Fork of the Salmon have proven to be very successful (Cole 2000b). See figure 69.



Figure 68—An information sign.



Figure 69—Before their float trip, rafters listen to a brief talk about outdoor skills specific to river, riparian ecology, and ethics.

## Conceptual Design

This is a sample conceptual design illustrating some of the information covered in this publication. Before work begins, understand the affects of grading on existing vegetation, drainage patterns, and streambank stability. Disturb as little of the land as possible; grading for buildings, roads, spurs, and paths is minimal. Allow natural cycles to occur unimpeded. For example, don't alter a stable bank and don't build on the flood plain.

### Restoration and Recreation Planning Objectives

The campground is large enough to be economically feasible without destroying the riparian ecosystem.

Visual quality and natural features, such as rock outcrops and vistas, are inherent in the restoration or new design.

Campground is sited above the flood plain on a plateau.

All visitor-use areas and amenities are designed away from known wildlife-use areas.

Accessible paths lead to the restrooms and to the sandbars so all visitors can experience the site amenities.

### Site Design

Campground loop roads are designed/laid out perpendicular to the stream, which is the attraction. Loops perpendicular to the attraction encourage visitors to walk down the roads to get to the stream instead of walking cross country.

An information kiosk and a pay station are located by the restroom at the bottom of the loop. These common interest areas to most visitors are placed here to encourage people to use the road rather than to trample vegetation.

Paths lead to two sandbars. A low fence runs along the streamside of each path to protect the riparian



ecosystem by preventing visitors from trampling the vegetation between the path and the stream.

A bridge is used to cross the stream. The abutments are set into the bank so wildlife can cross under the road and fish and other aquatic species can move upstream and downstream unencumbered. The bridge is wide enough to accommodate two-way traffic

and a sidewalk, for pedestrian safety. The sidewalk encourages visitors to cross the stream over the bridge instead of trampling the streambanks.

Visitors are directed through a network of hardened paths to access the water via the sandbars.

Sandbars can be used as beaches and offer open

spaces and shade. They are also renewable. Sandbars significantly reduce the impacts to vegetation, soil, and wildlife because access to the water is controlled and not occurring indiscriminately along the streambank.

### Recreation Management

Trail signs lead visitors to the water and other site amenities, and additional signs explain why it is important to stay on paths.

All roads, spurs, and paths are surfaced with 4 to 6 inches of aggregate or paved. Paths can be surfaced with wood chips to reduce erosion and delineate use areas.

A fence runs along the east boundary of the campground to discourage visitors from going beyond the area. The riparian ecosystem is maintained intact by preventing trampling and compaction and by not disturbing wildlife.

### Soil Protection

Construction (restoration or new installation) can cause streambanks to be compacted and left bare. This could lead to destabilization. Soil bioengineering is used to restore vegetation (structure and function) to banks. Hardscape materials such as steel and riprap won't grow and they shift over time. They don't support the riparian ecosystem.

Figure 70—Design Principles

# Example of How Principles are Implemented

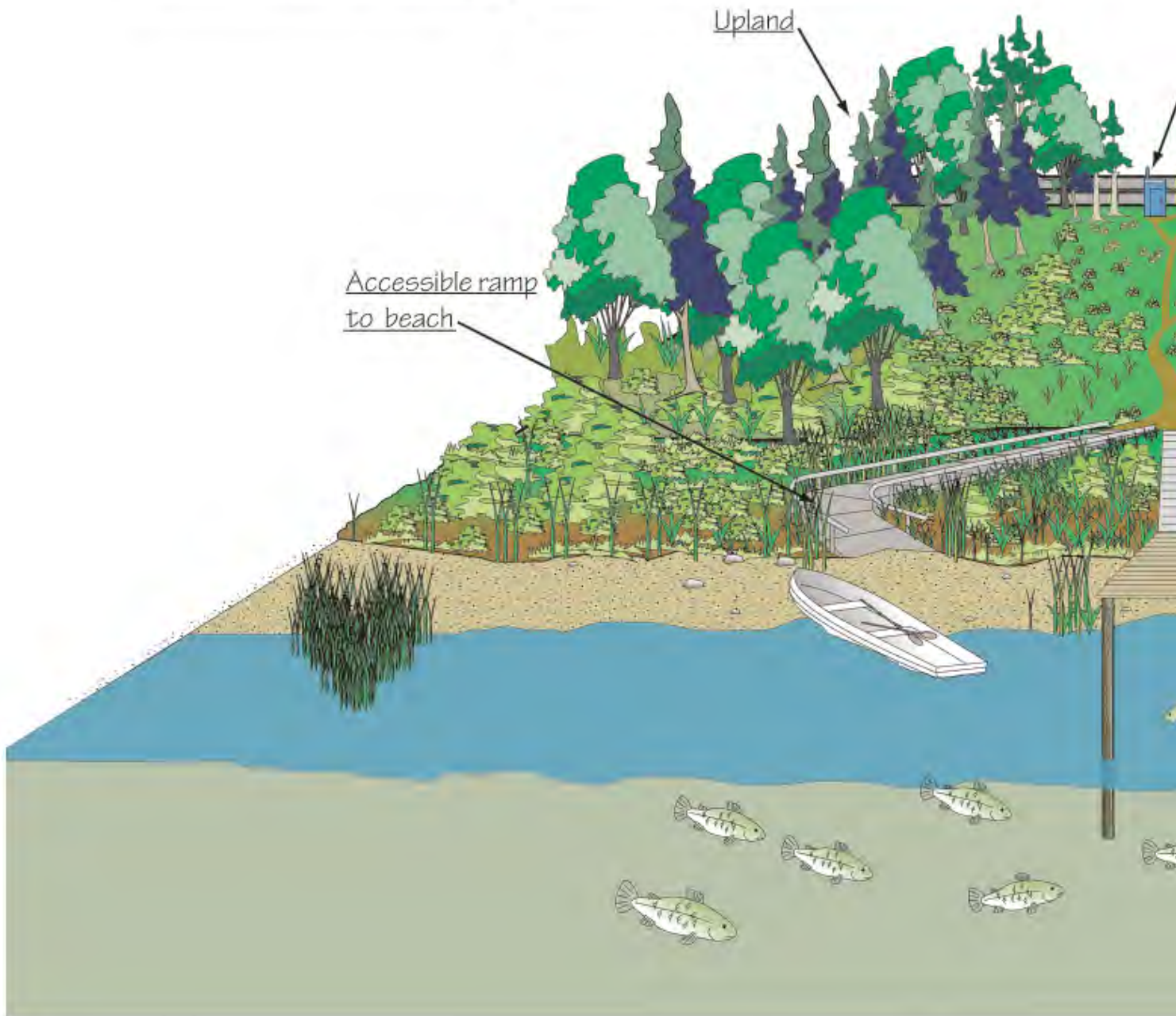
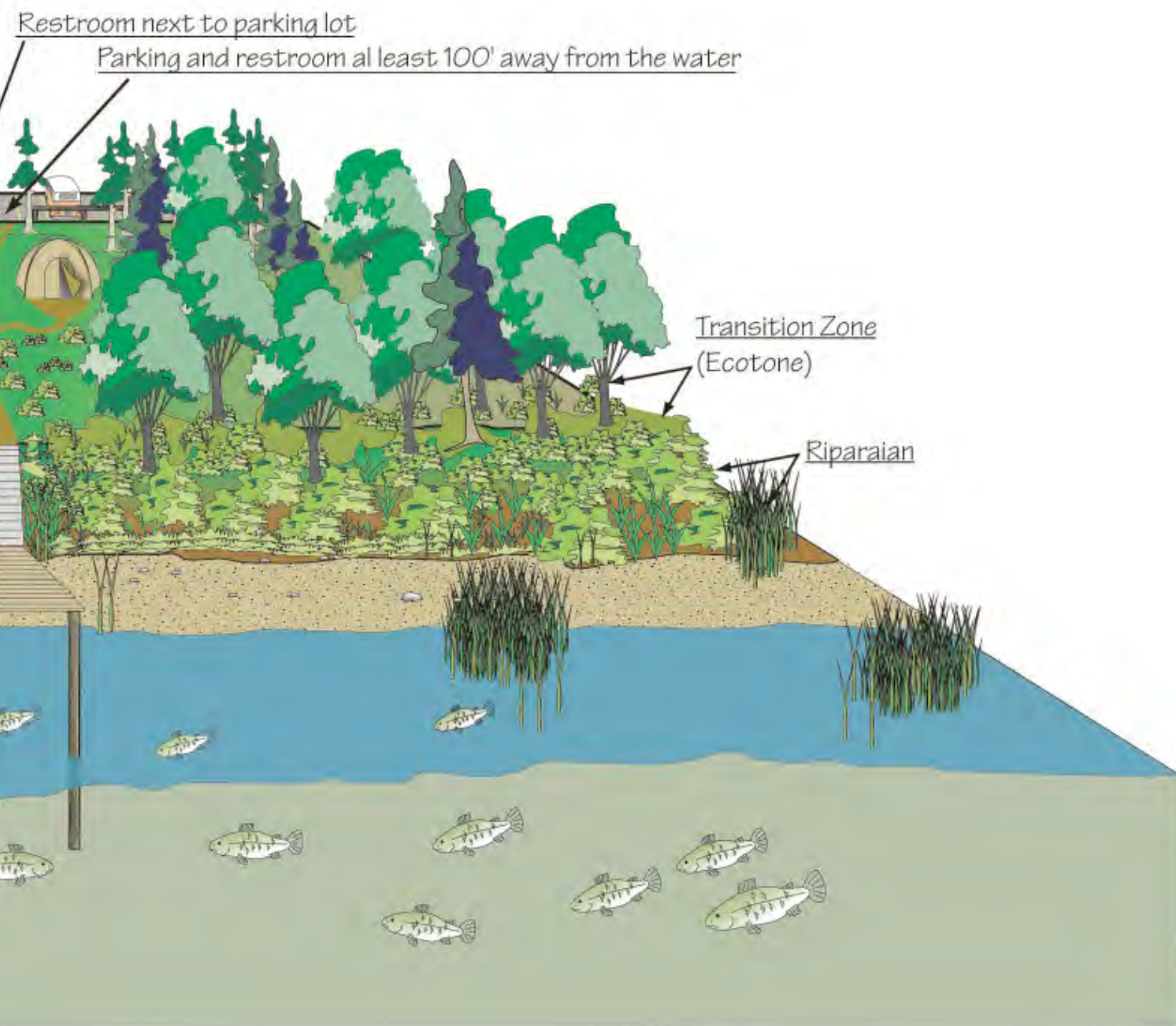
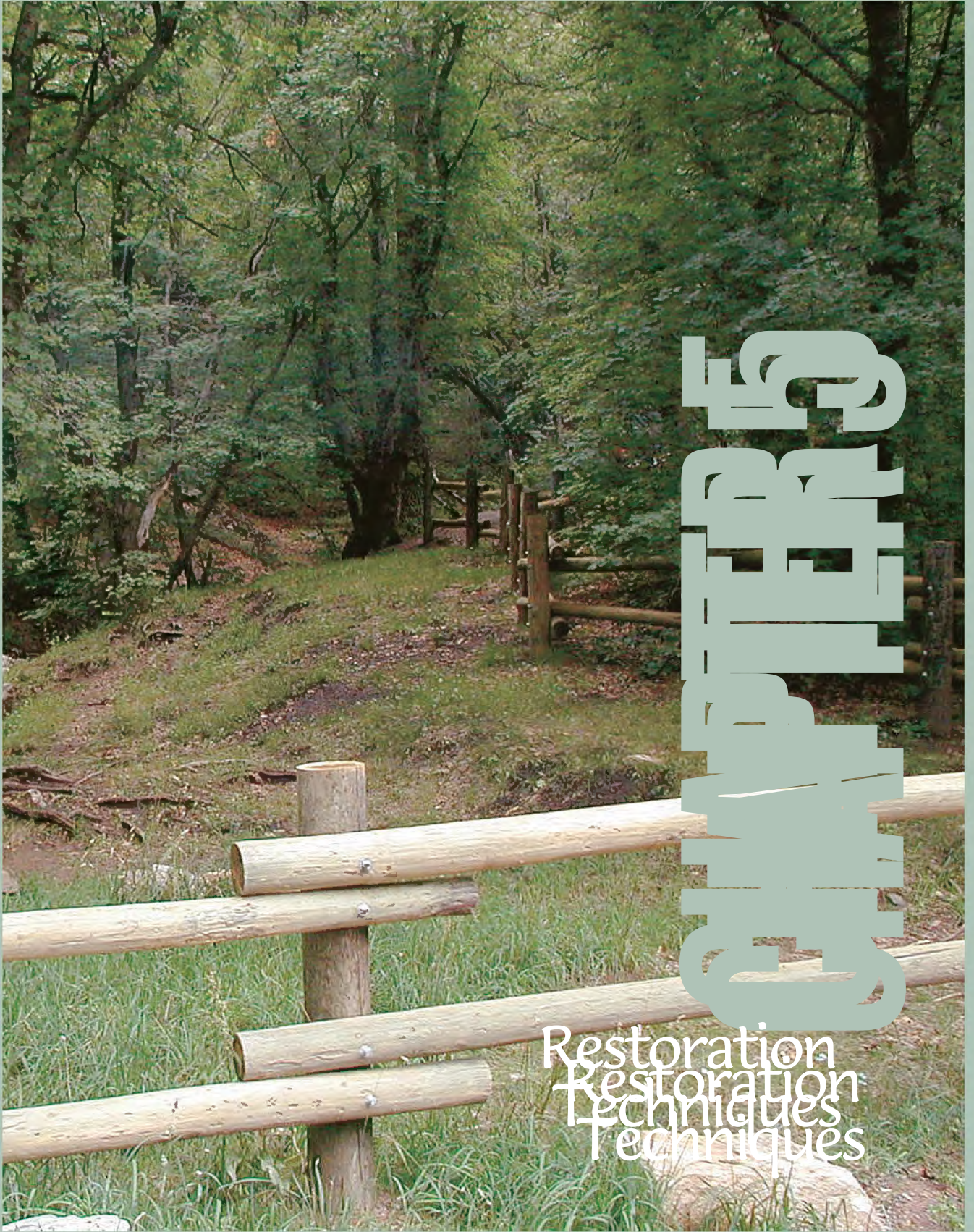

Figure 71—Implemented principles.









# Restoration Techniques

Restoration  
Restoration  
Techniques  
Techniques

## RESTORATION TECHNIQUES

This chapter provides practical approaches for workers involved in restoration.

### Soil

Soil condition is a critical concern in restoration. Soil health is particularly important for success because soil compaction and soil characteristics affect soil permeability and plant vigor. Compaction is site specific. Certain soils, such as sand, might show shallow compaction, while others, such as clay and silt, could compact to 2 feet. Workers should test soil composition and make borings to check for a clay lens (hardpan), for instance. Because soil types vary across a site, workers should take more than one test.

To test easily for soil compaction, workers can use a regular shovel with a rounded edge. Workers should be able to dig easily in moist soil. If, when stepping on the shovel, it slides into the soil, this generally indicates that the soil is not compacted. If the shovel bounces off the soil or the effort requires repeated jumping on the shovel that just chips away at the surface, the soil is compacted. It is important to do this at multiple site locations.

Workers can determine where the compaction stops and what the soil horizons look like by digging a hole at least 18 inches deep. A sharpshooter spade (18 inches long and 4 to 6 inches wide) will penetrate the soil well; another option is using mechanized equipment. After digging the hole, a worker would lie on the ground, reach into the hole, and try to push a knife blade into the dirt down the side of the hole. Eventually, the knife should slide in with little or no effort, indicating where the compaction stops (Mueller 2000). Soil horizons should be visible. Workers should observe layers of deposition and should consult a soil scientist to determine whether the topsoil, or horizon A, is intact and compacted or absent, and whether subsoils B or C are exposed.

Workers should check the soil for the presence of living organisms, which show that the soil is not sterile (Soil and Water 2000). Affected soils may have high salinity, which may reduce riparian plant vigor. Irrigation-caused leaching, agricultural drainage, and dams can cause salt accumulation due to changes in

flow patterns. Workers should test the site's soil pH to determine whether it will support the site's native riparian plants. They should remove contaminated soil.

In complex projects, the team should invest in a site-specific soil survey. The soil survey will characterize the soil and give the chemical properties, the amount of productive elements that might be lacking for plant growth, the physical properties for engineering use in the field, and the water-holding capacities. Forest Service soil scientists can do this work.

Soil compaction can be reversed by providing a way for water and air to saturate the soil. A soil scientist can help decide which of the following decompacting techniques are appropriate to the site:

**Shovel.** If an area is small and not very compacted, a shovel is effective. In general, if the topsoil is deep enough (within the same soil horizon), the soil can be turned over. If the topsoil layer is thin, the soil should not be turned over. In Yosemite National Park, shovels were used to decompact social trails and areas with well-established vegetation (trees and large shrubs). Shovels were driven into the ground and moved back and forth to loosen and decompact the soil without disturbing vegetation (roots) (Cunningham-Summerfield 2000). The soil was not turned over, keeping the soil profile intact and leaving existing vegetation undisturbed.

**Long bar.** A 5- to 6-foot-long metal bar with a footrest punches holes in the ground to increase water infiltration through piping. (It also can create holes for plant cuttings.)

**Auger.** An auger is used in spring or fall to drill 6- to 12-inch-deep holes, depending on the depth of the compaction, at 1-foot intervals. The holes allow water to pipe or drain into the soil. For example, meadows in the Great Basin have been aerated using a  $\frac{3}{4}$  inch power ship auger with a total bit length of 15 inches (Chambers 1999).

**Excavator and backhoe.** The teeth on the bucket of an excavator and backhoe can rip soil 4- to 6-inches deep, or deeper. Unlike other excavators, the Gradall

excavator has a bucket that can be rotated in a wrist-like motion and a telescoping boom that can rotate 360 degrees.

**Dozer with ripper.** A dozer or tractor with a ripper attachment treats large areas. The tines are 12 to 18 inches long. Work from the tree dripline away from the tree and rip approximately 50 percent of the ground surface (Mueller 2000). The attachment is mounted on a three-point lift hitch or a hydraulic system that can be connected into it. A Bobcat also can pull tines.

A subsoiler, a ripper with wing-like blades, can be attached to the dozer to fracture soil strata at depths up to 36 inches. The subsoiler lifts the soil, breaking through the hardpan, “without burying the forest floor or topsoil or bringing unfavorable subsoils to the surface” (Gov. of British Columbia 1997). Using the subsoiler allows moisture to infiltrate to a deeper depth. The subsoiler should be used in the dry season when there is less plant growth. This instrument is appropriate for pastures, some roads, and other wide-open spaces. Rippers or subsoilers may be used in rocky soils, depending on the size and characteristics of the rocks; it does not work with boulders, but does work with large round rocks. See figure 72.

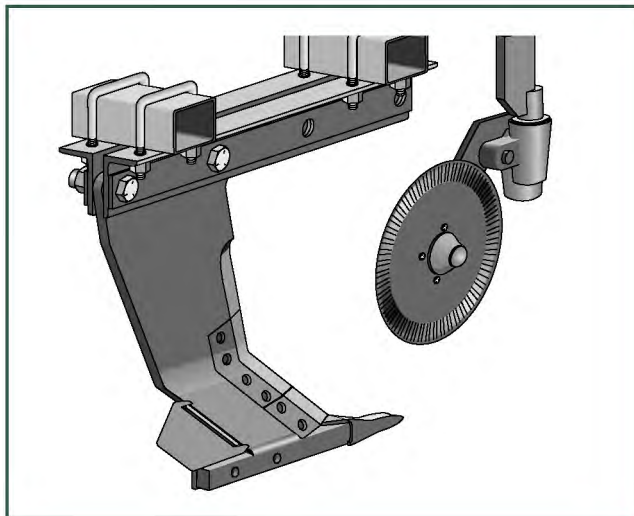

Figure 72—Subsoiler. (Courtesy of Bigham Brothers, Inc., TX)

The ripper or subsoiler requires multiple passes to rip an open area such as a former parking lot or open untreed compacted areas. According to Mueller,

Natural Resources Conservation Service (NRCS), four passes will yield better results. Approach the ripping area from a different direction each time, with the last pass being across the slope to create rough horizontal rows to catch runoff and precipitation (Mueller 2000). It is important to decompact areas that may have been compacted during the recontouring process.

When decompaction is not enough to revive the soil to sustain healthy plants, workers should till in soil amendments or green waste. They should not amend the soils to change the soil type, but rather to rebuild nutrients and the microorganisms that help sustain healthy soils.

Workers can bring in topsoil, but it is expensive. A Forest Service soil scientist, NRCS specialist, or a local nursery employee can provide information. In areas that are totally denuded, grasses or certain other soil-building plants can rebuild the soil. This is a long-term process.

## Hydrology

It is extremely important for workers to reconnect the site as much as possible to its natural hydrology at ground and subsurface levels. Soil temperature and water availability for plants are notably affected by depth of the water table and by growing season conditions such as variable annual rainfall and air temperature. Regrade the site to restore the topography and reconnect contours so natural drainage occurs. The soil should be left rough and not bladed smooth; the roughness slows runoff and enables nooks and crannies (microcatchments) to foster water infiltration and seed germination.

## Riparian Vegetation Recovery

The following are three approaches to riparian vegetation recovery:

1. Remove the persistent degrading agent, humans, goats, sheep, cattle, llamas, geese, and exotic plants, and allow the area to recover on its own. Riparian plants evolved with frequent natural disturbances; this resilience allows them to recover when imposed uses are curtailed. A passive restoration technique is probably most effective in climates and soil conditions that

have an inherent resiliency; for example, when the soil is relatively healthy and in wetter climates. In arid climates, recovery will take longer.

2. Plant a nurse crop of an early successional collection of herbaceous plants and subshrubs (Rieger 2000).
3. Plant a significant amount of the species found in the transects. See figure 73. Plant seeds, cuttings, and rooted stock of the same species; if the seed does not sprout, the plants and cuttings may grow or vice versa. Seeds and rooted stock/cuttings used together provide stability and permanence. If species are dioecious, use a ratio of one male to five female plants/seeds (this may vary with the species). [Both genders are planted to achieve cross-pollination, and more females are planted for increased seed generation.] (Evans, as seen in Griggs and Stanley 2000). Also, a mixture of seeds and rooted stock is less expensive than rooted stock alone. Note that moisture availability, soil health, and a microclimate specific for certain plants can be limiting factors to success (Zabinski and Cole 2000).



Figure 73—A restored riparian ecosystem in San Diego.

Evans suggests that the “life strategy” of a plant (or its place in ecosystem development) helps determine what form to plant it in; for example, plant an annual from seed. His plant categories are as follows:

1. Soil Builders—Early successional (mostly fast annuals from seed)
2. Opportunistic pioneers—Early successional (mostly herbaceous perennials and semiwoody subshrubs). Plant annuals from seed; plant perennials from seed and from containers.
3. Climax community—Late successional (mostly permanent woody shrubs and trees). Plant rooted stock or cuttings. (Griggs and Stanley 2000).

The combination of seeds with cuttings and rooted stock is good for flower and seed production, wildlife habitat, and microclimate development. Rooted stock and cuttings quickly provide shade, shelter, moisture retention, and leaf mulch (a microclimate) for seeds and smaller plants that might need these conditions to survive. Plants that require shade should be planted at a later date, if necessary, although they may come in on their own once site conditions are favorable. Seeds that germinate, whether they mature or not, will provide soil-building nutrients.

Workers should always pay attention to how the plant variety and density varied in the reference site. Over time, soil variability and natural mortality will create gaps (Rieger 2000).

### Stimulate the Growth of Native Plants

In order to grow, all plants need “live” soil; it is as important as water. Fungi, bacteria, arthropods, protozoa, and nematodes form a soil food web. Many of these organisms are missing from severely disturbed soils. Mycorrhizal fungi, for example, form associations with plant roots that remarkably enhance the plant’s uptake of nutrients. Different plants like different fungi (Soil and Water 2000). Plants can be inoculated with the fungi before they are planted. Although products are available for such inoculations, this field of study is relatively young.

One way to amend soils and give plants a good start is to use leaf litter, duff, or soil from an adjacent healthy riparian area or the reference site. When gathering media, workers should be as specific as possible by taking leaf litter, duff, and soil from the

same plant-community type that they are trying to reestablish. They should add the medium to the hole that is dug for a plant or till it into the soil.

It is important not to fertilize. In addition to stifling growth of beneficial nematodes, fertilizers add a “blast” of nitrogen that stimulates weed growth more than native plant growth. To achieve a slow release of nutrients, workers should use green waste (compost created from yard waste within a local municipality) or native duff.

### Weed Control

Generally, weeds outcompete plants by using the soil moisture (Lardner 1999). One of the objectives in weeding is to shift the balance to more native plants and fewer weeds, allowing the native plants a chance to grow and take over. Mulching is a good way to suppress weeds without resorting to herbicides, although some weed growth always will occur while the plants are becoming established. Such weed growth can hide the new plants from browsing animals.

Workers should rid the soil of weeds before work begins on the site. If there are only a few weeds, they should dig them out; otherwise, they should use the herbicide Rodeo® where appropriate. Rodeo® breaks down faster than other herbicides and has been approved by the U.S. Environmental Protection Agency (EPA) for use near water; Roundup® has not. Weeding should begin (when no crust is present on the soil) as soon as weeds appear. It is important to find the source, if possible, and eradicate it. Workers should know when weeds will drop their seeds and avoid disturbing them during this period. Disturbance may cause seeds to disperse farther than usual. Before the seedpods have opened, workers should cut off seed heads and place them in a plastic bag. The State weed abatement office can advise on destroying weed seeds.

Soils that have a crust layer are also important for weed control. If a crust exists, it is important not to pull the weeds out; this will break up the crust and make it easier for weed seeds to sprout. The weeds can be killed by cutting them off at the ground or by applying an herbicide (where permitted).

The Bradley Method of eliminating exotic plants advocates pulling errant weeds and those on the edges of a mixture of native and exotic plants (Bradley 1971). It is labor intensive. This proven technique is outlined in appendix D.

### When, What, and How To Plant

This section addresses climate considerations and approaches to planting seeds, transplants, cuttings, and rooted stock.

Local weather conditions dictate when to plant. Consult a botanist, a soil scientist, a native plant horticulturalist or local horticulturalist (nurseryman), a landscape architect, or a NRCS employee for the best times to plant. Geographic location and soils will dictate planting season and whether or not irrigation is needed. In some places, cold weather is a limitation. If planting is done in early spring, roots have time to become established before winter. On the other hand, drought or dry summers and mild winters may necessitate fall planting when there is a better chance for precipitation. Mancini (1989), for example, reports, “Winter is the best time to plant in desert riparian areas due to low evaporation rates and thus greater saturation of soil from surface to water table.” Ask for local advice about when to plant.

To preserve genetic integrity workers should gather seed and plant material from an adjacent site, or at least from the same watershed. If seeds or plants are purchased from a nursery, the nursery should maintain records that show where the materials came from to ensure a genetic match. If a nursery is hired to do the collection, workers must tell nursery personnel where to collect what species.

Restoration companies will gather seeds and cuttings and grow plants for projects and/or help set up a nursery to provide an ongoing stock of the genetically correct plant materials. Where plant material is in short supply, avoid repeatedly taking cuttings because it will negatively affect the structure and function of an area. If workers need an ongoing supply of cuttings, they can establish a nursery or orchard of specific species for harvesting purposes. Specifics for harvesting, storing, and planting cuttings are in appendix B.

Spacing for rooted stock, cuttings, and seed broadcast amounts vary with species and planting densities desired. Placing cuttings and rooted stock too close together can cause too much competition, which leads to plant mortality. When possible, workers should plant trees instead of shrubs and vines because they generally form the dominant element of the riparian ecosystem (Stanley 2000).

Workers can use a waterjet stinger or power auger to bore a hole to the dry-season water table before inserting the plant cuttings. The waterjet stinger does more than create a hole for the cutting. It saturates the soil the length of the hole, and “liquefied soil settles around the cutting eliminating air pockets around the root zone that prevent root growth” (Hoag and others 2001). Details about the waterjet stinger and its uses are in appendix C.

## Planting Considerations

### Seed

Seeds have a higher degree of failure than do rooted stock. Workers should—

- ◆ Seed large areas to provide a quick grass cover. Protect the seed with a layer of hydromulch and tackifier to reduce seed loss during precipitation (Fritzke 2001). Hydroseeding is also an option. See figure 74.
- ◆ Order pure live seed (PLS), if possible, when using a commercial grower. PLS stipulates that the order shall be only seed and no incidental debris or weed seed.
- ◆ Look for local seed mixtures already being gathered by local, native-plant nurseries (there are several in the Prairie States).
- ◆ Use seedpods. Cut the stem and stick it in the ground so the pods are held upright above the ground. The pods will open and disperse the seeds. (See figure 75.)
- ◆ Remember that seeds may require time in the ground for germination to occur.



Figure 74—Seeds were used to begin restoring riparian vegetation on this flood plain.



Figure 75—Seed pods on a stem.

### Transplanting

Workers should—

- ◆ Dig up a native plant, transport it to the restoration site, and replant it. Keep earth around the roots intact.
- ◆ Trim plants back before moving them, leaving several 2-foot tall stems.
- ◆ Trim vines to 9- to 12-inch lengths before transplanting.

### Cuttings

Workers should—

- ◆ Cut cuttings from plants that will root well from a cutting. Consult a native plant nursery in the area to be sure (USDA NRCS 1996).
- ◆ Cut dormant material for live stakes 3/4- to 1-inch in diameter and straight. It is not unusual for a willow cutting to be 4 to 6 feet long (Hoag and others 2001).
- ◆ Plant all cuttings, using the waterjet stinger or other methods that have similar results, into the dry-season water table. Note: Workers in Yosemite Valley are using a waterjet stinger and nothing but cuttings on their riparian restoration projects and are seeing 90 percent survival rates. (Fritzke 2001)
- ◆ Cut dormant material for live posts 4 to 6 inches in diameter. Saw off the side branches. It is not unusual for a cottonwood cutting to be up to 10 feet long. Cuttings can be up to 20 feet long, with one-third of the length extending above the ground (USDA FS, Boise 1998). Tall live posts are especially good when cattle are still on the land (Rieger 2000). See figure 76.

Cuttings can be inserted horizontally into channel and lake banks for stability.



Figure 76—Live cutting.

**Rooted stock**

Rooted stock has a higher degree of success than do seeds. Nurseries may have rooted stock from the project area. They or the workers can collect native cuttings and/or seeds and grow the stock. See figure 77. It may take 2 years or more for plants to produce enough woody growth to survive in the wild. Workers should—

- ◆ Use hardwood seedlings that have a minimum of four or five large lateral roots (Tjaden and Weber ND). Ask the horticulturalist when the plants are large enough, then take one out of the pot and check its root system.



Figure 77—Rooted willow stock.

- ◆ Use 1-gallon sizes. The root mass and its moisture-holding ability will support the plant (Rieger 2000). Loosen any tightly entangled roots.
- ◆ Use 5-gallon sizes, or ball and burlap stock the equivalent of 5 gallons, if the site may be subject to sedimentation, so the entire plant is not completely covered up (Rieger 2000). With ball and burlap plants, the ball is measured in inches. The size of the ball should be large enough to support a tree with a certain caliper (trunk diameter). A rule of thumb is 1 foot of ball diameter for each 1 inch of caliper (Fazio ND).
- ◆ Use 4-inch pots on small jobs, and be sure adequate moisture is available to the plant’s small root system (Rieger 2000). This size is not recommended for arid climates.

- ◆ Use rooted stock in sandy soils where soil moisture is ensured. (Cuttings generally do not do well in this type of soil (Fowler 2000).)

**Planting Specifics**

Workers should—

- ◆ Plant woody species rooted stock and transplants with their crowns 0.5 to 2 inches above the soil surface. Build a water retention basin around each plant. On a slope build a crescent basin, leaving the uphill side open. The berm of soil on the downhill side will capture runoff. Fill the basin with water. Tamp the soil to squeeze out air bubbles and add more soil, if necessary. Be sure the crowns are exposed. See figure 78.

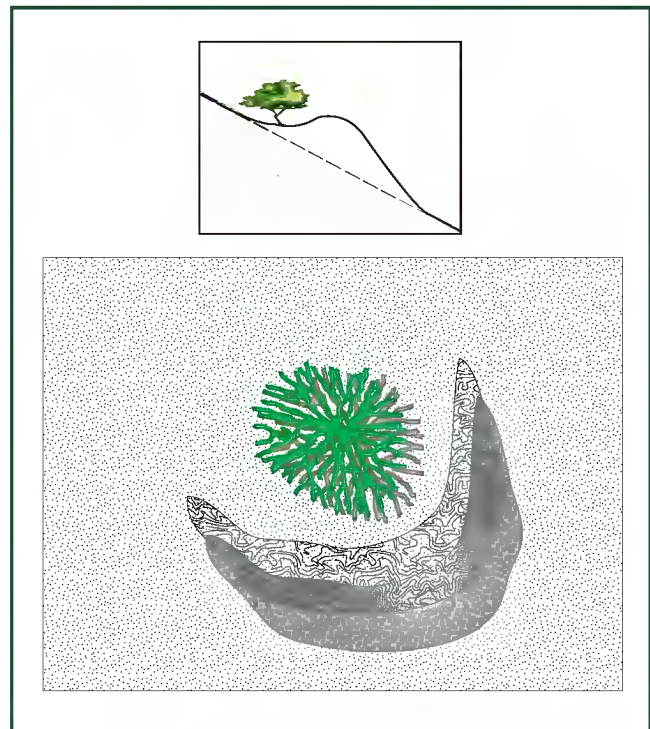

Figure 78—A water retention basin will catch water to help keep soil moist.

- ◆ Plant herbaceous plants with their crowns even with the ground level.
- ◆ Consult with specialists on planting times and irrigation needs.



## Pests

The following methods are used to combat pests. (See appendix D.) Workers should—

- ◆ Overplant a bit and lose a few plants to browsing and gophers. (Do not do this if there is an overpopulation of animals, deer for instance.)
- ◆ Install a plastic or cardboard weed mat at the base of plants to lessen weed competition.
- ◆ Install a chicken-wire basket around plant roots to protect against rodents. Be sure baskets are large enough to avoid restricting roots. Be sure the soil has a high enough mineral and water content to rust the cages (ask the soil scientist), or they will end up girdling the roots and the plants will die. Do not use stainless steel wire. (If an area floods near planting time, rodents may not be a worry for a while. Flooding kills some rodent populations.)
- ◆ Use wire cages to protect individual plants from browsing, if possible. Use planting collars to protect seeds, seedlings, and cuttings during the first year of growth.
- ◆ Use 4-foot plant collars or tubes on trees and shrubs if browsing and rodents are a problem. Tubes are made of translucent material or mesh.
- ◆ Install raptor perches and/or barn owl boxes, if these birds are native to the site, to encourage the presence of rodent-eating birds.

## Mulch

Mulch holds moisture in the soil, helps prevent wind and rain erosion and rain compaction of soil, and helps control weeds. Workers should mulch up to 2 inches deep. Seed size may dictate mulch thickness. A larger seed, such as an oak, benefits from thick mulch. The mulch hides the seeds from birds and squirrels, so more seeds germinate. A thin layer of mulch would promote the germination of a different type of seed at the expense of the oak, for instance (Dunmore 2000).

Mulch can be clean, weed-free rice straw; clean, shredded hardwood from the forest; or leaf litter and humus (duff) from adjacent sites. Leaf litter may be

the best mulch because it is native to the site and contains native seeds. Some of these seeds will germinate and provide more plants in the restoration site. Humus provides organic matter to promote plant growth and soil regeneration. Bark chips are not recommended because they decompose slowly, robbing nitrogen from the soil, and they have a tendency to float away and do not knit together (LaFayette and others 2001).

In high mountain projects, scarification and adding organic matter and compost before planting and seeding did result in higher success rates than just scarification or scarification and organic matter. Test plots showed that mulch resulted in greater canopy development and a smaller increase in height (Cole and Spildie 2000).

## Irrigation

In many parts of the United States where rain is plentiful or the ground water is high, irrigation may not be necessary. When irrigation is necessary, workers should use sprinklers and avoid drip systems; drip tubing is quickly eaten by wildlife. They can pump water from an adjacent channel or lake using a portable generator, or use a water truck. In general, workers should water during the dry months of the first year after installation.

Water until the soil is deeply saturated to enhance deep root growth and survivability. A Yosemite National Park publication had two examples: One site was irrigated for a 24-hour period once per month; another was irrigated for 8 hours twice a month. Both had similar survival rates despite extremely porous, sandy-to-cobbled soils (Tucker 1998). These sites were watered during the dry months for the first year after installation. It is important to check the saturation level on the site; one watering per month may be too little and the soils may be different, dictating a different watering profile. Workers should consult a soil scientist, local botanist, landscape architect, native-plant society, or nursery about irrigation frequency and duration.

Recently, staff at Yosemite revised its irrigation ideas. If a restoration site is in full sun and precipitation has been limited for 1 month, plants are irrigated using

the above saturation method. July, August, and September are the dry months. If the cuttings are in the shade, they receive no irrigation. Cuttings are planted using the waterjet stinger, so it is assumed that their roots will be at the dry-season water level. The irrigation is to ensure survival when there is little precipitation (Fritzke 2001).

## Management

Most project success comes from good management. Genesis of projects can also come from good managers who notice problems and seek solutions.

Studies sponsored by the Carhart National Wilderness Training Center have shown the following management strategies to be successful:

- ◆ Minimize visitor impacts by controlling distribution and location of visitor use (Cole as quoted in Alexander and Fairbridge 1999).
- ◆ Tell visitors what fees are used for; this has produced positive responses.
- ◆ Close and restore campsites. This strategy is seen as active management and has strong visitor support (Cole 1997). A closed site may take 10 years or longer to restore (Cole 2000c). Many factors affect recovery time, including climate, soil conditions, and inherent resiliency of an ecosystem.
- ◆ Involve the public through education and information. “Educating our visitors [and potential wildland visitors] about proper behavior on public lands and communicating effectively with them will be the foundation for making them partners in management, not passive recipients of authoritarian regulation and control.” (Lucas 1986) The nonprofit organization, Leave No Trace, Inc. (LNT), has a partnership with the USDA Forest Service and has developed many information packets. LNT will also assist, at no cost, in developing new information sheets (National Outdoor 1996).
- ◆ To be effective, recreation management depends on simultaneous consideration of both social and physical-biological goals. Management of recreation impacts is largely management of people’s perceptions, behaviors, and needs

(Cole as quoted in Alexander and Fairbridge 1999).

- ◆ Intensified site management to protect natural resources is a good strategy. “The ultimate goal of the programs would be to minimize the areal [of, relating to, or involving the area] extent of physical impacts by channeling traffic and rehabilitating some portion of existing damaged sites. Certain trails, day-use areas, and campsites would be designated for use, while others would be closed off and restored. Visitors would be asked to use open trails and to stay off closed trails and areas.” (Cole 1997)

## Adaptive Management

Once the site is restored, adaptive management ensures the integrity of the site. Adaptive managers use original project objectives. They must be measurable. These monitoring objectives, which support the natural processes of the restoration site, are used as management guides. For example, if a section of the site is being misused, the management makes changes to address this misuse and to ensure the continued health of the riparian ecosystem. In other words, management techniques are changed or adapted to continue to meet the project objectives.

In some cases an objective may seem unachievable, making it easy to dismiss it and dash off a new objective, which is not good management. To dismiss an objective, a manager needs to describe what method was used to determine that the objective could not be met. In other words, the manager should document the decision using scientific evidence. When new objectives are forged, the manager should describe how they will be measured, a timeline for attainment, and a method for discerning when they are not achievable.

## Monitoring and Maintenance

Monitoring and maintenance are intertwined; monitoring may lead to maintenance and vice versa. Both are critical for project success.

## Monitoring

Monitoring is a way to ascertain a project’s success. Workers should monitor a project for at least 5 years to see that growth is occurring. It is important to

monitor the vegetation's growth and its functions. Workers might ask, for example, how animals are using the area or whether erosion has lessened. They might also monitor appropriate and inappropriate uses by visitors, site managers, maintenance crews, and other personnel.

The project objectives, which are really performance objectives, can serve as monitoring objectives. Two examples of such objectives are—

- ◆ Native vegetation will increase in density by 50 percent, as one indicator of riparian functional and structural characteristics, in 5 years. When the 50 percent density level is achieved, the site should continue to be monitored to ensure that native plant density does not dip below 50 percent.
- ◆ Resident bird species will increase by 20 percent in 3 years.

Riparian ecosystems are subject to flooding, so plant growth may not be steady, and drought, flooding, wind, normal streambank erosion, sediment deposition, and so on will affect plant growth and survival. Note whether the riparian structure and function are returning and whether the vegetation is becoming a self-perpetuating riparian plant community. A self-perpetuating riparian plant community equates to restoration. To compare what is happening on the restoration site to the reference site, use the same sampling techniques to gather information on both sites.

Photographs can help monitoring efforts by showing changes over time. Workers should establish set photo points to use before restoration, immediately after restoration installation, and at set intervals into the future. They can use survey or global positioning system (GPS) coordinates to site photo points accurately to consistently photograph the same area from the same point; this makes comparison possible. If the photo point changes, it is difficult to track the same spot's progress. If workers pound a rebar or survey marker into the ground below ground surface as a reference point, they can use a metal detector to locate it later.

Workers should also monitor the project by doing the following:

- ◆ Note which plants are doing well and which did not survive.
- ◆ Observe whether a correlation exists between the growth rate of certain cuttings and the “mother” plants. Keep track of where seeds, cuttings, and plants were harvested.
- ◆ Determine whether the installation is functioning as designed.
- ◆ Note which areas are maturing more rapidly than others and why.
- ◆ Note which seeds germinate in various locations.
- ◆ Determine which native plants have returned to the site through natural succession.
- ◆ Observe what has sprouted in the second season. Some plants may have died after the first year and some plants may have just come alive.
- ◆ Note which areas are experiencing difficulty and why. This may be natural for a small area that has a different soil type, for instance.
- ◆ Observe whether streambanks and lakeshores are stabilizing or are washing away and why.
- ◆ Note if something is occurring that is a surprise.
- ◆ Determine which planting techniques are succeeding and which are not.
- ◆ Observe whether an increased number of shrews, deer mice, voles, gophers, and earthworms are present in the soil. (Their presence is good.)
- ◆ Note what wildlife is using the area and for what purposes.
- ◆ Observe whether macroinvertebrate levels have changed. If they have, determine whether the change is for better or worse.
- ◆ Note whether the water temperature is changing.
- ◆ Note whether the soil moisture is changing. If it is, determine whether the change corresponds to a certain decompaction method used.

### Monitoring for use

Adaptive management cannot take place unless the restored site is monitored. Monitoring can catch a problem before it is out of control, and adaptive management enables managers to change management to address problems.

Indicators, which are characteristics that change in response to use, are part of monitoring/managing objectives. Loss of woody debris in and around campsites and bare mineral soil both indicate that structure and function may be threatened. Absence of expected wildlife might also be an indicator (Elzinga and others 1998).

“Visitors will use the hardened beach path 90 percent of the time” is a project management objective. Managers can monitor this by looking for social trail development and trampled vegetation. (Social trails need to be blocked immediately upon discovery, vegetation replanted, and further use discouraged.) If visitors are not using the hardened path, managers need to find out why and take action. They might ask if the path is in the wrong place, or if it is a matter of visitor education.

Managers should monitor for the following:

- ◆ Are individuals—
  - ❖ Staying on the trails?
  - ❖ Taking shortcuts?
  - ❖ Trampling vegetation?
  - ❖ Cutting down vegetation?
  - ❖ Trampling banks?
- ◆ Is the site overcrowded?
- ◆ Are inappropriate uses occurring; if so, what are they?
- ◆ Has the area been trampled, grazed, or driven over?
- ◆ What is working as planned; what is not working as planned?

It is important to determine whether campsite dimensions are expanding by using “Campsite Monitoring Instructions” in appendix F.

### Maintenance

Maintenance of a newly installed project is absolutely necessary during the first few years after installation or until the vegetation becomes established. Site maintenance is critical to giving the project every chance to be effective over a long period. Project partners may be willing to assist in maintenance. Workers should—

- ◆ Repair fences, replant and reseed as necessary, and remove weeds and excessive debris that may shade and compete with cuttings and new plants.
- ◆ If a flood occurs days after installation, not an uncommon occurrence, replant and rebuild structures as necessary.
- ◆ Inspect the project every other week for the first 3 months after installation, then once per month for the next 6 months, and every 2 months for at least 2 years. Inspect after heavy precipitation, flooding, snowmelt, drought, or an occurrence that is out of the ordinary.
- ◆ Check for damage from the following:
  - ❖ flooding
  - ❖ wildlife
  - ❖ grazing
  - ❖ a fetch
  - ❖ boat wakes
  - ❖ trampling
  - ❖ drought
  - ❖ high precipitation

Table 1 is a sample monitoring form. Use it or your own version to fit your projects. Be sure that monitoring and maintenance are part of each project.

Appendix G contains techniques for establishing plants in an ecosystem.

Appendix H includes publications and internet sites.

Table 1.

<b>Riparian Restoration Site Monitoring Worksheet</b>		
Location Name: _____ Date: _____		
Forest & District: _____		
GPS Reading: _____		
Quad Map Coordinates: _____ Photo Pt. Coordinates: _____		
Check If Done	Monitor	Results
	Percentage of seeds that sprouted.	
	Percentage of cuttings that sprouted	
	Percentage of cuttings that survived into the second growth season	
	Which plants are doing well?	
	Where did they come from?	
	Which plants did not sprout?	
	Is there a diversity of plants?	
	Are certain areas growing faster than others? Why?	
	Which and how many invasive or exotic plants are present?	
	Is weeding program needed?	
	Is the weeding program working?	
	Which techniques appear to be most successful?	
	How deep are the roots after the first two years?	
	Has soil moisture changed?	
	Has the water temperature changed?	
	Are wildlife using the area? For what?	
	Is the soil improving?	
	Is the bank or shoreline stable?	
	Are there problem areas? Why?	
	Is there a browsing or gopher problem?	

### Examples of Restored Riparian Recreation Sites

The following sites are examples of riparian restoration. Photographs depict each site.

#### Fourth of July Campground on the Cibola National Forest

See figures 79 and 80. Visitors used to walk right on the streambed. Foot traffic has been redirected to outside the fence. These photographs were taken 3 years apart; two were drought years. The streambank shows recovery.



Figure 79—Trampled streambank.



Figure 80—Recovering streambank.

### **Las Huertas Picnic Area on the Cibola National Forest**

See figures 81 and 82. The photos were taken at the same spot several years apart. A stream is now accessed via a trail. Restoration efforts included removing the picnic tables, adding fill, and seeding and planting with native shrubs. Now there is no evidence of erosion.



Figure 81—Picnic site with eroding and compacted soil.



Figure 82—Trail leading through restored site.

### **Las Huertas Picnic Area on the Cibola National Forest**

See figures 83 and 84. The first photo shows degradation that occurred during a construction project. The second shows the recovered area. It was graded and seeded, vehicles were restricted, and pedestrians were discouraged from using the area.



Figure 83—A muddy mess.



Figure 84—A helping hand and resilience allowed recovery.



### **Las Huertas Meadow Area on the Cibola National Forest**

See figures 85 and 86. This meadow was a maze of paths. The first photo shows the boardwalk immediately after construction. The second photograph was taken 6 years later. Pedestrians use the boardwalk, and the riparian vegetation is coming in on its own. The gravel path in the foreground is on dry land and leads to a parking area.



Figure 85—A newly built boardwalk through a trampled meadow.



Figure 86—Boardwalk and new vegetation.

**Devil’s Elbow Picnic Area, Yosemite Valley, Yosemite National Park**

See figures 87, 88, and 89. This was a popular picnic area on a meander bend on the Merced River. Until 1984 it was also a concessionaire raft takeout spot. Madej and others (1991) estimated that since 1919 approximately 50 feet of bank retreat had occurred at the site because of human impacts. This study documented the extent of soil compaction, bank erosion, and tree die-off and caused the U.S. Department of the Interior, National Park Service, to take action.



Figure 87–Devil’s Elbow Picnic Area, 1993.



Figure 88–Spring flooding in 1996 and winter flooding in 1997 left sediment deposits on the flood plain. There was no erosion.



Figure 89—Signs on this fence along the road explain the project to visitors and provide directions to river access.

Riparian restoration efforts began in 1993. Picnic tables, fire rings, two pit toilets, and an asphalt parking area were removed, and visitors were directed away from the eroding bank. The soil was ripped 6 inches deep using the tines of an excavator, which achieved soil decompaction and aeration. Installing brush layering and vertical cuttings stabilized the banks. This created a subsurface of stems and roots, which increased the tensile strength of the bank. The bank and the terraces were seeded with native seeds. Terraces were planted with cuttings and live posts. Plant choices were based on surrounding plant communities and the site's soils. Mulch was collected from Yosemite Valley, and plants were irrigated during the first summer.

According to Fritzke (2001), “there was a 90 percent survival rate of cuttings on the bank. Flooding in Spring 1996 and Winter 1997 resulted in deposition of silts along this outer edge of the meander bend due to the effects of the young willow and cottonwood plants slowing the flood waters.” This deposition helped to rebuild the bank.

A zigzag fence was installed to deter trespassers. Informational signs were installed to direct visitors to access points that lead to sandbars upstream and downstream from the site.

In 2001, “the willows and cottonwoods on the bank are nearly 25 feet tall, and the oaks on the terrace are 4 to 5 feet tall. The bank continues to build out into the river at a rate of about 2 to 3 inches per year, slowly recovering some of the area that had undergone such severe retreat since the early topographic maps of 1919” (Fritzke 2001).



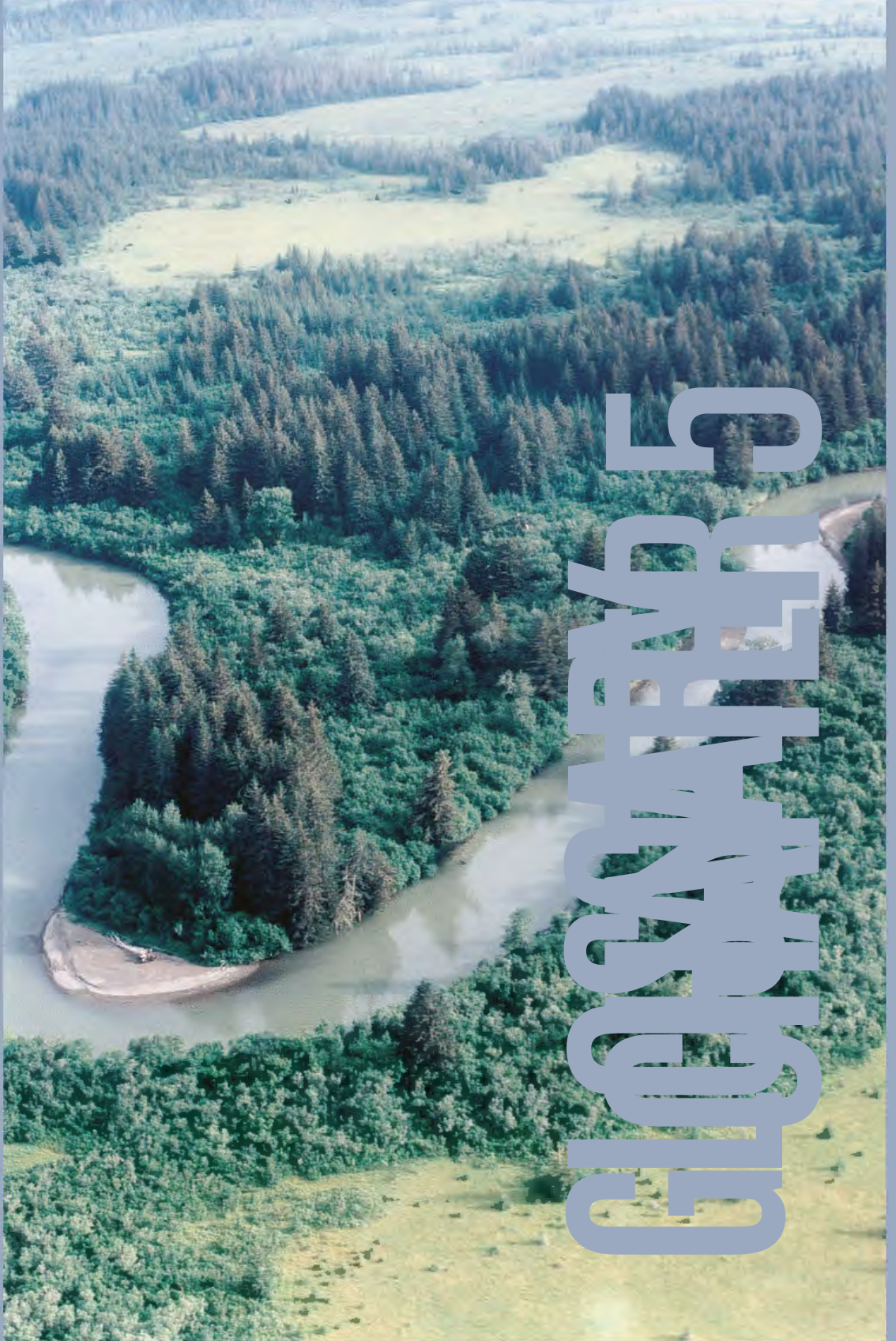

# Сельское хозяйство

## GLOSSARY

### **Aggraded**

The filling or raising of the streambed level caused by sediment deposition.

### **Aquatic ecosystem**

The stream channel, lake or estuary bed, water, and biotic communities, and the physical, chemical, and biological features that occur therein, forming a system that interacts with associated terrestrial ecosystems.

### **Bank failure**

The collapse of a mass of bank material.

### **Bankfull**

In natural streams, the discharge that fills the channel without overflowing onto the flood plain, as typically defined by the mean annual high flow.

### **Basal area**

In a tree, the cross sectional area of a tree trunk measured in square inches, square centimeters, and so on; basal area is normally measured as 4.5 feet above ground level and is used as a measure of dominance. The most commonly used tool for measuring basal area is a diameter tape or D-tape (then converted to basal area). In a plant, the cross sectional area of the stem or stems of a plant or of all plants in a stand. Herbaceous and small woody plants are measured at or near the ground.

### **Benthic**

Of or pertaining to animals and plants living on or within the substrate of a water body.

### **Bioengineering**

See soil bioengineering.

### **Biomass**

The total mass or amount of living organisms in a particular area.

### **Bog**

Waterlogged ground or marshland (also known as a wetland).

### **Bole**

The trunk of a tree.

### **Brush layering**

Live branch cuttings laid in crisscrossed fashion on benches between successive lifts of soil then buried; branches act to hold the soil in place, to absorb momentum from water flowing over the area, and to trap sediment.

### **Canopy cover**

The percentage of the ground covered by a vertical projection of the outermost perimeter of the natural spread of the foliage of the plants. Small openings within the canopy are included. It may exceed 100 percent (Society for Range Management 1999). It is expressed as a percent of the total area.

### **Channel**

A stream, river, or artificial waterway that periodically or continuously contains moving water. It has a definite bed and banks that confine the water.

### **Connectivity**

Unbroken linkages in a landscape, typified by streams and riparian areas.

### **Corridors**

Linear spaces that connect the various areas of an animal's habitat; links between feeding, watering, rest, and breeding places.

### **Cover**

Any material that provides protection for fish and/or wildlife from predators or that ameliorates adverse conditions of stream flow and/or seasonal changes in metabolic costs. It may be instream structures such as rocks or logs, turbulence, and/or overhead vegetation or any material that provides areas for escape, feeding, hiding, or resting.

### **Cutting**

Portion of a stem, root, or leaf cut from a parent plant for the production of a new independent plant by inducing it to form roots under favorable environmental conditions.

**Debris**

Any material, organic or inorganic, floating or submerged, moved by a flowing stream.

**Density**

The number of organisms or items per unit area or volume; the number of individuals per unit area.

**Dioecious**

Having male and female flowers borne on separate plants.

**Diversity**

The distribution and abundance of different plant and animal communities.

**Dominance**

The spatial extent of a species; commonly the most abundant species in each vegetation layer. Dominant species: Plant species or species groups, which by means of their number, coverage, or size have considerable influence or control upon conditions of existence of associated species (Society for Range Management 1999).

**Duff**

A spongy layer of decaying leaves, branches, and other organic materials covering the forest floor.

**Ecosystem**

An ecological community considered together with nonliving factors of its environment as an environmental unit. A community of interacting animals, plants, and microorganisms and their environment.

An area of any size with an association of physical and biological components so organized that a change in any one component will bring about a change in the other components and in the operation of the whole system (Bailey 2000).

**Ecosystem function**

(a) The process through which the constituent living and nonliving elements of ecosystems change and interact, including biogeochemical processes and succession. (b) A role of an ecosystem that is of value to society.

**Ecotone**

A relatively narrow overlap zone between two ecological communities.

**Erosion**

Detachment and movement of soil or rock fragments by water, wind, ice, or gravity; the land surface worn away by running water, wind, ice, or other geological agents, including such processes as gravitational creep (Society of Range Management 1999).

**Exotic**

Not native to a given area; either intentionally transplanted from another region or introduced accidentally. Synonym: nonindigenous.

**Fish habitat**

The aquatic environment and the immediately surrounding terrestrial environment that meet the necessary biological and physical requirements of fish species during various life stages.

**Flood plain**

Any lowland that borders a stream or river and is inundated periodically by its waters.

**Function**

The collective interactions of the animal and plant life of a particular region. The interactions between organisms and the physical environment, such as nutrient cycling, soil development, water budgeting, and flammability.

**Green waste**

Compost created from yard waste by a municipality or native duff.

**Habitat**

A place where a biological organism lives. The organic and inorganic surroundings that provide life requirements such as food and shelter.

**Herbicide**

Selective or nonselective chemicals that kill plants.

**Hydrology**

The study of the occurrence, circulation, properties, and distribution of water and its atmosphere.

**Hydroseed**

To spray land with a mixture of seeds, water, a virgin wood fiber (slurry) or recycled paper mulch, and a tackifier (a binding agent made from plants so the slurry will stick to the ground).

**Incised**

A stream that through degradation (lowering of the streambed) is cutting its channel into the bed of the valley.

**Indigenous**

The plant and animal species native (as opposed to exotic) to a site.

**Keystone species**

A keystone is the stone at the top of an arch that supports the other stones and keeps the whole arch from falling. A keystone species is a species on which the existence of a large number of other species in the ecosystem depends.

**Large woody debris (LWD)**

Any large piece of woody material, several inches in diameter and equal to or greater in length than the average bankfull width, that intrudes into or is embedded in the stream channel.

**Litter**

The uppermost layer of undecomposed and decomposing plant and animal material found above the duff layer on a forest floor.

**Macroinvertebrate**

An invertebrate large enough to be seen with the naked eye; for example, most aquatic insects, snails, and amphipods.

**Mowing**

The cutting of grasses and forbs mechanically or manually.

**Mycorrhizal**

The symbiotic relationship between the mycelium (mass of interwoven hyphae) of a fungus with the roots of a higher plant in which the hyphae (threads growing from the fungus) form an interwoven mass at the root tips or penetrate the parenchyma (thin-walled living cells) of the root.

**Organic matter**

Living plant tissue and decomposed or partially decomposed material from living organisms.

**Overland flow**

Water flowing over the surface of the land, as in runoff or overbank flows.

**Pattern**

The plan view of the various patterns a stream or river might take—straight, meandering, braided, and so on.

**Plant community**

Any assemblage of populations of plants in a common special arrangement.

**Pollutant**

Something that is harmful, destructive, or deadly.

**Pool**

A topographical low in the stream that is produced by scour or cleared by flushing that generally contains fine-grained sediments.

**Profile**

Slope of water surface and dominant channel features, e.g., riffle, pool, or rapids (Rosgen 1996).

**Proper functioning condition**

“A riparian-wetland area is considered to be in proper functioning condition when adequate vegetation, landform, or large woody debris is present to:

- ◆ dissipate stream energy associated with high waterflow, thereby reducing erosion and improving water quality;
- ◆ filter sediment, capture bedload, and aid flood plain development;
- ◆ improve flood-water retention and ground-water recharge; develop root masses that stabilize streambanks against cutting action;
- ◆ develop diverse ponding and channel characteristics to provide the habitat and water depth, duration, and temperature necessary for fish production, waterfowl breeding, and other uses;
- ◆ support greater biodiversity” (Prichard 1998).



**Pure live seed (PLS)**

Pure live seed has no incidental debris or weed seed mixed with it.

**Regrade**

To intentionally reconfigure the elevations and slopes on a parcel of land by means of surveying technology and construction equipment.

**Riparian vegetation**

Vegetation specifically adapted to grow along banks of streams, rivers, and other water bodies tolerant to or more dependent on water than plants further upslope.

**Scarification**

The act of breaking up and loosening the soil surface.

**Sediment**

Soil particles that have been transported and/or deposited by wind or water action.

**Sediment load**

The sediment transported through a channel by stream flow.

**Seedling**

Young plant, grown from a seed.

**Site**

The spatial confines of a particular project.

**Soil amendment**

Organic matter made of decaying plants. Used to improve or maintain a soil's texture and encourage healthy root growth.

**Soil bioengineering**

An applied science that combines structural, biological, and ecological concepts to construct living structures for erosion, sediment, and flood control. It is always based on sound engineering practices integrated with ecological principles.

**Soil survey**

The systematic examination, description, classification, and mapping of soils in an area. Soil surveys are classified according to the kind and intensity of field examination (Soil Science 1997).

**Species composition**

The proportions of various plant species in relation to the total on a given area. It may be expressed in terms of cover, density, weight, and so on (Society of Range Management 1999).

**Streambank**

The sideslopes of a channel between which the stream flow is normally confined.

**Stream channel**

A body of running water moving over the Earth's surface in a channel or bed (also river).

**Structure**

The spatial arrangement of the living and nonliving elements of an ecosystem.

**Succession**

The development of a plant community from its initial stage to its climax stage.

**Terrace**

Abandoned flood plain that marks where a stream once existed.

**Transect**

Specifically shaped sample units. Items with a transect may be counted, cataloged, and so on.

**Transition**

A shift in plant composition as reflected in composition and structure. A shift can occur naturally or as a result of human actions.

**Tree dripline**

The outer edge of a tree's growth. An imaginary vertical line from the farthest reaching horizontal branch to the ground delineates a dripline.

**Undercut bank**

A bank that has had its base cut away by water action causing the bank to overhang the stream.

**Watershed**

An area of land surface defined by a topographic divide that collects precipitation into a stream. Sometimes referred to as a drainage basin.

**Water table**

The depth or level below which the ground is saturated with water.

**Wetland**

An area of land that is saturated at least part of the year by water. Usually found in depressions, low-lying areas or along flood plains, or in coastal areas.

**Wildlife habitat**

An area that provides a water supply and vegetative habitat for wildlife.

**Woody debris**

Coarse woody material, such as twigs, branches, logs, trees, and roots, that falls into streams.





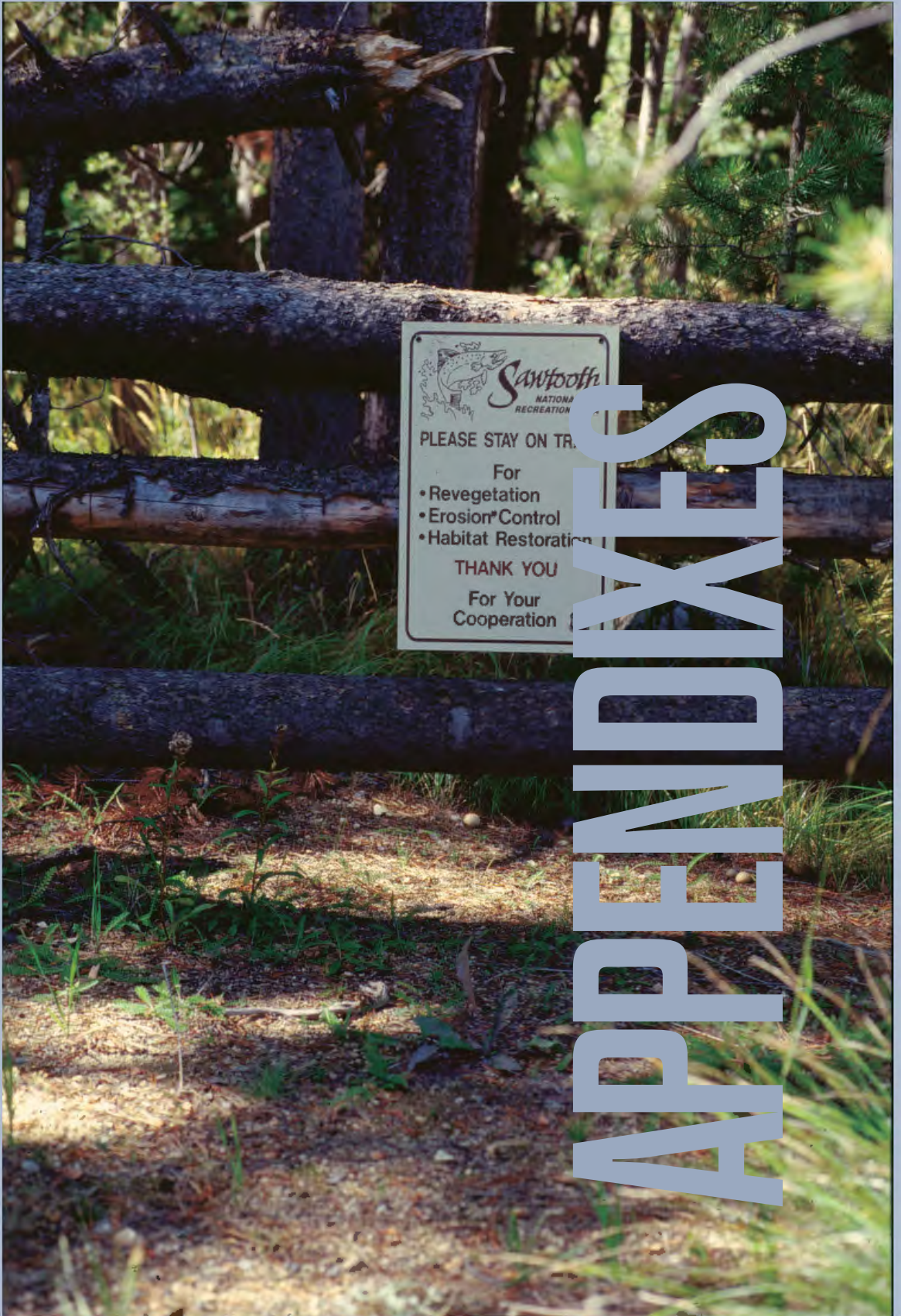

# APPENDICES

# Impacts of Recreation on Developed and Dispersed Sites

## Recreation Activity

Impacts	Camping	Picnicking	Hiking	Hiking & Biking Around Obstacles	Mountain Biking	Equestrian Use	Wood Gathering	Plant Harvesting	Use of Staging Areas	Use of Scenic Overlooks
Soil compaction		X	X	X	X	X	X	X	X	X
Puddles		X		X		X				
Ruts		X		X	X	X	X	X		
Runoff		X		X		X				
Rills & gullies		X		X		X				
Changes in distribution of runoff		X		X	X	X				
Flood plain isolated from flooding										
Loss of soil moisture	X	X		X		X	X	X		
Addition of water to site/stream										
Extraction of water from stream/site										
Erosion	X	X		X	X	X	X	X	X	X
• Petroleum products	X	X							X	X
• Septic-visitors & pets	X	X	X		X	X			X	X
Wastewater discharge										
Vegetation manipulation	X	X		X		X	X	X	X	X
Edge affects	X	X	X	X	X	X	X	X	X	X
Loss of plant vigor	X	X		X			X	X		
Loss of plant biomass	X	X		X			X	X		
Trampling	X	X		X	X	X	X	X	X	X
Loss of soil cover	X	X		X			X	X	X	X
Loss of riparian structure and function	X	X		X		X	X	X	X	X
Destabilization of streambanks & lakeshores			X	X	X	X	X	X		
Loss of shelter	X	X	X	X	X	X	X	X		
Loss of breeding habitat	X	X	X	X	X		X	X		
Loss of forage	X	X	X	X	X	X	X	X		
Disturbance or loss of aquatic habitat			X	X	X					
Exposure of wildlife to foreign disease	X	X	X	X	X	X	X	X	X	X
Noise	X	X	X	X	X		X	X	X	X
Dust, smoke, exhaust	X	X	X	X	X	X			X	X

# Impacts of Recreation on Developed and Dispersed Sites

## Recreation Activity

Impacts	Combat Fishing	Water Play	Boating: Motorized & Non	Portage of Canoes, Rafts, Kayaks	Snow-mobiling	Snow-mobiling Off Trail	OHV Use On Authorized Trails/Roads	OHV Use Off Trails/Roads	Unauthorized User-made Trails	Parking Outside Designated Areas
Soil compaction	X	X	X	X	X	X	X	X	X	X
Puddles	X			X				X	X	X
Ruts	X	X		X				X	X	X
Runoff	X	X		X				X	X	X
Rills & gullies	X	X		X				X	X	X
Changes in distribution of runoff	X			X				X	X	X
Flood plain isolated from flooding										
Loss of soil moisture	X	X		X				X	X	X
Addition of water to site/stream	X	X		X				X	X	X
Extraction of water from stream/site										
Erosion	X	X	X	X				X	X	X
Petroleum products			X		X	X	X			X
Septic-visitors & pets	X	X	X	X	X	X	X	X	X	X
Wastewater discharge	X			X				X	X	X
Vegetation manipulation	X	X		X		X		X	X	X
Edge affects	X	X		X	X	X	X	X	X	X
Loss of plant vigor	X	X		X		X		X	X	X
Loss of plant biomass	X	X		X		X		X	X	X
Trampling	X	X		X		X		X	X	X
Loss of soil cover	X	X		X		X		X	X	X
Loss of riparian structure and function	X	X		X		X		X	X	X
Destabilization of streambanks & lakeshores	X	X	X	X		X		X	X	X
Loss of shelter	X	X		X	X	X		X	X	X
Loss of breeding habitat	X	X		X	X	X		X	X	X
Loss of forage	X	X		X	X	X		X	X	X
Disturbance or loss of aquatic habitat	X	X	X	X	X	X		X	X	X
Exposure of wildlife to foreign disease	X	X		X	X	X	X	X	X	
Noise	X	X	X	X	X	X	X	X	X	X
Dust, smoke, exhaust	X	X	X	X	X	X	X	X	X	X

# Impacts of Recreation on Developed and Dispersed Sites

## Support Facilities and Construction & Maintenance Activities Related to Recreation

Impacts	Roads & Trails	Buildings	Parking Lots	Picnicking & Camping Sites	Mowing Streambanks & Lakeshores	Trash Accum. & Collection	Snow-making	Filling Floodplain	Realignment of Stream/River Channel
Soil compaction	X	X	X	X	X	X		X	
Puddles	X	X	X	X				X	
Ruts	X	X	X	X				X	
Runoff	X	X	X	X				X	
Rills & gullies	X	X	X	X	X	X		X	
Changes in distribution of runoff	X	X	X	X	X			X	X
Flood plain isolated from flooding	X	X	X	X				X	X
Loss of soil moisture	X	X	X	X	X			X	X
Addition of water to site/stream	X	X	X	X	X		X	X	X
Extraction of water from stream/site							X		X
Erosion				X	X	X		X	X
Petroleum products	X		X	X	X				
Septic-visitors & pets				X					
Wastewater discharge		X							
Vegetation manipulation				X	X			X	X
Edge affects	X	X	X	X	X			X	X
Loss of plant vigor				X	X			X	X
Loss of plant biomass				X	X			X	X
Trampling				X	X	X		X	
Loss of soil cover				X	X			X	X
Loss of riparian structure and function	X	X	X	X	X		X	X	X
Destabilization of streambanks & lakeshores				X	X		X	X	X
Loss of shelter	X	X	X	X	X		X	X	X
Loss of breeding habitat	X	X	X	X	X		X	X	X
Loss of forage	X	X	X	X	X		X	X	X
Disturbance or loss of aquatic habitat	X	X	X	X	X		X	X	X
Exposure of wildlife to foreign disease				X	X	X	X	X	
Noise	X	X	X	X	X		X		
Dust, smoke, exhaust	X	X	X	X	X		X		





## APPENDIX B

### Handling Plant Materials; Harvesting, Storing, and Installing Cuttings

#### Handling Plant Materials

- ◆ Collect plant materials and seeds within the watershed or local drainage basin at roughly the same elevation as the restoration site. Do not introduce nonnative or native plant materials and seeds from different gene pools.
- ◆ Know the genus and species of deciduous plants that grow well from cuttings before cutting.
- ◆ Collect cuttings when the plants are dormant.
- ◆ Plant dormant cuttings the same day or within 2 days after harvesting. Store cuttings in water or moist soil in a shaded area to prevent dehydration. (See Harvesting and Storing section.)
- ◆ Track where plant material was collected, the vigor of the material, and its survival rate. Manage good collection sites. Let personnel in other program areas know that this is a harvest area and that the plants have special uses.
- ◆ Transplant herbaceous plants from nearby banks immediately. Be careful not to take too much from any one spot.

#### Harvesting and Storing

Cuttings can be used within a day or two or stored through the winter.

- ◆ Harvest cuttings from branches that are at least 1 year old, but not older than 12 to 15 years. Do NOT cut branches with old, heavily furrowed bark, diseased or insect-infected growth, dead or broken branches, basal shoots, or suckers (Hoag 1994).
- ◆ Preserve the esthetics of the plant when taking cuttings. Do NOT cut off more than one-third of a single plant's branches. Avoid public-use sites, such as campgrounds, picnic areas, fishing sites, roadways, and so on (Hoag 1997).
- ◆ Cut dormant material for live stakes  $\frac{3}{4}$ - to 1-inch in diameter and straight. It is not unusual for a willow cutting to be 4 to 6 feet long (Hoag and others 2001).
- ◆ Shield cut branches from the sun at all times and keep them as cool as possible.
- ◆ Remove the apical bud at the top by cutting.
- ◆ Dip the top 1 to 3 inches of each post in a mixture of equal parts latex paint and water or paraffin to seal it. This decreases desiccation and identifies which end is the top (Hoag 1992).
- ◆ If necessary, store cuttings in a cool, dark place, such as a walk-in refrigerator, at between 34 and 45 degrees Fahrenheit, for several months. Wrap cuttings in burlap or peat to keep them damp.
- ◆ Move cuttings outside and soak the basal ends for at least 24 hours, and up to 14 days, before planting. This leaves cuttings well hydrated and causes the root buds to swell. Keep them moist and in the shade.

#### Installing Live Cuttings

- ◆ Install the basal end, not the top; the buds always angle upward.
- ◆ Insert the cutting into the ground without tearing the bark. The bark shields the cambium layer, the vascular system for the plant. The cutting will not survive if it is damaged when the bark is torn.
- ◆ Use a hydrodriller, or waterjet stinger, to install the cutting (live stake or live post) into the dry-season water table. A dead blow hammer can be used to install the cutting 3 to 5 feet deep if the soil is soft. Avoid splintering or mashing the top of a cutting with the hammer. There are several advantages to using the waterjet stinger (see appendix C). The waterjet saturates the soil so the cutting has moisture; the soil settles around the cutting, eliminating air pockets; and its use ensures that the bark and cambium layer on the cutting remain intact.
- ◆ Ensure good soil-to-stem contact or the cutting will dry out and fail to sprout.
- ◆ Work with a soil specialist to better understand limits and opportunities within the project area. Soil types and textures determine what vegetation will thrive in a particular area.

## Resources for Appendix B

Hoag, J. Chris. 1992. *Use of willow and cottonwood cuttings for vegetation shorelines and riparian areas*. Riparian/Wetland Project Information Series No. 3. Aberdeen, ID: U.S. Department of Agriculture, Natural Resources Conservation Service, Plant Materials Center.

Hoag, J. Chris. 1993. *Selection and acquisition of woody plant species and materials for riparian corridors and shorelines*. Riparian/Wetland Project Information Series No. 2. Aberdeen, ID: U.S. Department of Agriculture, Natural Resources Conservation Service, Plant Materials Center.

Hoag, J. Chris. 1994. *How to plant willows and cottonwood dormant pole cuttings for riparian rehabilitation*. Riparian/Wetland Project Information Series No. 4. Aberdeen, ID: U.S. Department of Agriculture, Natural Resources Conservation Service, Plant Materials Center.

Hoag, J.C. 1997. *Planning a project*. Aberdeen, ID: U.S. Department of Agriculture, Natural Resources Conservation Service, Plant Materials Center; Riparian/Wetland Project Information Series No. 2. (ID# 1194). 13p.

Hoag, J. Chris; Simmonson, Boyd; Cornforth, Brent; St. John, Loren. 2001. *Waterjet stinger: a tool to plant dormant unrooted cuttings of willows, cottonwoods, dogwoods, and other species*. Riparian/Wetland Project Information Series No. 17. Aberdeen, ID: U.S. Department of Agriculture, Natural Resources Conservation Service, Plant Materials Center.

## APPENDIX C

### Riparian/Wetland Project Information Series No. 17

June 2001

### Waterjet Stinger: A tool to plant dormant unrooted cuttings of willows, cottonwoods, dogwoods, and other species

**J. Chris Hoag**, Wetland Plant Ecologist

**Boyd Simonson**, Biological Technician

**Brent Cornforth**, Biological Technician

**Loren St. John**, PMC Team Leader. U.S. Department of Agriculture, Natural Resources Conservation Service, Plant Materials Center, Aberdeen, ID 83210

*[Used with permission.]*

### Introduction

Opportunities for riparian revegetation around the nation are numerous. Planting dormant unrooted cuttings often called pole plantings, post plantings, or live stakes is one technique that is often recommended for streambank stabilization and riparian buffer planting. This method is limited to species that can easily sprout from hardwood cuttings, such as: willows, cottonwoods, and dogwoods. There are other species that will sprout from hardwood cuttings, but do not root as readily. [See figure C1.]

Dormant unrooted cuttings are used because they are easy to harvest, easy to plant, inexpensive, and effective. In the arid and semi-arid West, it is extremely important that any plant that is installed in a riparian zone have its roots in the lowest watertable [sic] of the year. This is often difficult when using bareroot [sic] or containerized plants especially when the riparian zone has been dewatered to the point that the water table may be several feet below the soil surface. Unrooted cuttings have been planted as deep 12 ft (average depth is about 5-6 ft) by the Riparian/Wetland Plant Development Project at the Aberdeen PMC using a long bar attached to a backhoe (Hoag and Ogle 1994). Most riparian and stream protection projects require planting depths of 3-6 ft. The biggest problem we faced was finding a method and developing equipment that could dig a hole more than 3-4 ft deep quickly and efficiently. The Waterjet Stinger is the result of this equipment development effort.



Figure C1—Waterjet Stinger.

To plant unrooted cuttings successfully, the bottom of the cutting should be placed about 8-12 in into the lowest watertable [sic] of the year. The top of the cutting should extend out of the ground at least 10-12 in or high enough to be out of the shade cast by surrounding vegetation such as grasses or forbs. This allows the bottom of the cutting to act like a straw and pull water up the cutting keeping the roots, stems and leaves hydrated. In some riparian zones, the lowest water table of the year can be several feet deep.

### Waterjet Stinger

The Waterjet Stinger [figure C2] was specially designed to use high-pressure water to hydrodrill a hole in the ground to plant unrooted hardwood cuttings into riparian revegetation. This is not new technology, in fact, it has been around for a long time. Oldham (1989) described a water drill that he used to drill holes in the ground to plant stem and pole cuttings 4-5 ft deep. His hydrodriller was a steel pipe that was beveled at the bottom and was hooked up to a “water tank (spray rig) or portable pump.” Drake and Langel (1998) reported using a water jet tool to plant willow cuttings. They designed a nozzle that is made out of stainless steel welded to a steel pipe. They used a high-pressure pump and the nozzles to plant cuttings over 2 meters deep. An engineering technician in Manitoba, Canada (Andrews, personal communication) described working with a water jet to drill holes for geotechnical test holes ten years ago. He indicated that they had taken a steel pipe and pounded the end flat to increase the water pressure. These earlier jets did not last very long because the pounding tended to weaken the steel.



Figure C2.

The advantages of using the waterjet stinger to drill a hole for planting unrooted willow and cottonwood cuttings are: [figure C3]

- 1) simple to operate and transport
- 2) little training necessary to operate
- 3) hydrodrilling the planting hole is fast
- 4) plant large number of cuttings in a short period of time
- 5) allows cutting to be planted directly into a wet environment
- 6) allows for saturated soil conditions to surround the cutting for a longer period of time
- 7) liquefied soil will settle around the cutting eliminating air pockets in the rooting zone [sic]



Figure C3—Waterjet nozzle.

Based on a request from Scott Henderson, an Idaho NRCS Field Office employee, and others, Boyd Simonson, PMC Biological Technician, used the paper written by Drake and Langel (1998) and attempted to modify their design to better fit the coarse soils in the Intermountain West. He started with the actual probe itself. A local machinist used the detailed drawing to build the nozzle out of stainless steel and welded it to a ½ in steel pipe. Boyd added a T-handle at the top to help with the planting operation and a ball valve at the handle to turn the water on and off (see appendix A). [See figure C4.]

After testing in the field, we decided to add a set of vanes to be [sic] bottom on one of the probes. Three vanes were welded to the probe pipe directly above the stainless steel tip. The individual vanes were



Figure C4—Handle with ball valve.

about four inches long, tapering down to the nozzle, and about 5/8 inch tall. The vanes provide several benefits. They open the hole up all the way down to accept wider diameter cuttings. This is especially true in compacted layers like clay. They also allow the user to nudge rocks slightly out the way in the hole. With the smooth pipe, it is almost impossible to get any leverage on rocks. For silt soils, the vanes are a real help. With cobbly soils, it does not provide a major advantage. We work in a combination of silts and gravels so we put vanes on one probe and left the other without vanes. [See figure C5.]



Figure C5— Garden hose quick coupler manifold.

It took quite a bit of research to come up with the right size pump. Drake and Langel (1998) describe a “cube” pump, but we had difficulty finding anything with that name. We determined that the basic specifications for the pump were:

- 1) gasoline powered
- 2) small enough to fit on the back of an ATV
- 3) output of at least 80 psi or higher
- 4) 120 gallons/minute output
- 5) vertical lift of at least 18 ft

There are many different pumps that meet these specifications available on the market.

We did try a 1,600-psi pressure washer thinking that it was ready made for this type of application. The main problem is that pressure washers do not put out enough water volume for this application. The pressure washers typically put out about 2-3 gpm while the high-pressure pump puts out 120 gpm (about 12-15 gpm at the nozzle). Pressure washers have more than enough water pressure, but they tend to blow all the soil out of the hole for the first couple of inches making it pretty messy. After the hole is drilled, there is very little water left in the hole to hydrate the willow cuttings. We do not recommend using a pressure washer for this application.

Next, Boyd felt that for safety’s sake, a pressure relief valve should be installed so when both waterjets were shut off, the water from the pump would bypass back into the stream or other water source. This would decrease the pressure on the pump and eliminate turning the pump on and off. A manifold was designed to fit on the pump to allow the water to flow from the stream to either the waterjet stingers or to the bypass hose. When a certain internal pressure is reached inside the manifold, the water will divert to the bypass hose and back into the stream automatically. An additional benefit to the pressure relief valve was that it allows one to release air out of the system. This made the priming go much faster.

The garden hose quick coupler manifold allows two waterjets to run simultaneously. [See figure C6.] It is attached to the main manifold just past the pressure relief valve. Quick couple attachments (available at



Figure C6.

most lawn and garden stores) are used to keep the connections simple, reduce the possibility of stripping the treads on the hose ends, and to allow the hoses to be hooked up in either direction. Water is delivered through heavy-duty  $\frac{5}{8}$  in garden hoses with a pressure rating of 100 psi that are 100 ft long. The hoses run from the garden hose quick couple manifold to the waterjets.

At the planting site, the hoses are laid out parallel to the stream channel. The two waterjets can be operated with two separate crews. One crewmember runs each waterjet and the other crewmembers transport the cuttings and push them into the holes after they are hydrodrilled. As the holes are hydrodrilled and planted in the 200 ft length, the ATV with the waterjet stinger pump is driven further down the streambank and the process starts all over again. If the streambank is too high and the lift is too great to get water from the stream to the pump, the pump can be dismounted from the ATV and placed on a flat shelf that is cut right into the streambank. This way the pump is placed closer to the water, lift is reduced, and pressure increased at the nozzles.

## Planting Process

Once the pump is set up and pushing water to the waterjets, hydrodrilling holes can begin. Planting sites with vegetation are scalped down to mineral soil to get rid of competing above ground biomass. The waterjet is placed in the center of the scalp and the ball valve is turned on. At this point most beginning users get nervous about being splashed with water. [See figure C7.] We have found that water rarely

splashes up, rather it tends to bubble as it liquefies the soil. Splashing might occur if the hydrodrilling is attempted on soils that are crusted or have a hard layer. However, as soon as the waterjet goes through the surface layer of soil, the splashing is eliminated (except in rocky soils).



Figure C7.

After turning on the ball valve and the water starts jetting out of the nozzle, the waterjet will slowly start sinking into the ground. If a hard layer is encountered, the waterjet will stop. If the user leaves the waterjet in place and let the water work on the layer, eventually it will go through it. We have demonstrated this with several demonstration projects from a site with a 6 in hard calcic layer to a site with a 2 ft thick layer of decomposed granite. If medium sized rocks (with lots of fines around them) are encoun-

tered, the user must wiggle the jet back and forth until the water can find a way around it. This does make a larger hole below the surface, but the liquefied soil will normally settle back into place after the cutting has been installed. [See figure C8.]



Figure C8.

As the waterjet liquefies the soil, it will continue down until it hits something it cannot cut through, the T-handle hits the ground, or the user stops. We have held the waterjet at a stationary point to have the water cut further into the soil. We have been able to duplicate Drake and Langel's (1998) depth of 6.6 ft (2 m). The depth the waterjet will penetrate depends mainly on the soil texture and the length of the probe.

As the user pulls the waterjet back up out of the hole, the nozzle should be rotated back and forth to increase the size of the hole. The rotation should continue the entire length of the hole from the bottom to the ground surface. The waterjet probe is  $\frac{1}{2}$  in diameter and the user should be planting at least  $\frac{3}{4}$  in diameter or larger cuttings (Bentrup and Hoag 1998, Hoag 1993). In order to get larger diameter cuttings in the hole, the soil needs to be liquefied all the way to the soil surface.

Once the hole has been hydrodrilled, the single cutting or a bundle of three to four cuttings can be pushed into the hole. The longer one waits to shove the cutting into the hole, the higher the chance there is to [sic] for the suspended sediment to settle to the bottom of the hole. This will limit the depth that the cutting can be pushed to.

An alternative option is to start the hole with the waterjet and then place the cutting or bundle right next to the waterjet pipe and push both the waterjet and the cuttings into the hole at the same time. [See figure C9.] If done properly, the cutting or bundle will go down as the waterjet liquefies the soil. If the cutting hits a tight spot, the operator will immediately know it and he can spiral the nozzle around a little to loosen the obstruction. A word of caution—make sure that the cutting does not extend past the nozzles or the pressurized water will cut the bark off.

One problem that we have observed is that if there is a coarse soil layer under a layer of fine textured soil, when the waterjet drills into this coarse layer, the water in the hole will drain out into the coarse layer. This will defeat the purpose of planting the cuttings into a slurry to eliminate air pockets. Pulling the waterjet nozzle up to just above the layer will allow sediment to settle back into the bottom of the hole and seal it again.

We have found that a three-person team per waterjet works very well for the planting process. One member of the team runs the waterjet, the other two members haul the cuttings and shove them in the holes. The



team members can rotate jobs through the planting day to keep everyone fresh and interested in the planting job. An extra person to transport the cuttings from the soaking location to the planting location with another ATV will speed the process up. The speed of the entire planting process will depend upon the soil, the labor force, and the cutting or bundle sizes. Once the cutting is shoved into the hole to the depth of the low water table, the sediment will start to settle around the stem. It is important that the operator not allow significant amounts of sediment to bubble up out of the hole while drilling. The more sediment that is allowed to bubble out, the more sediment that will have to be replaced after the water moves out into the surrounding soil. After planting, the planting team needs to return to each of the stems and replace soil that bubbled out and created a depression around the stem. The depression is caused [sic] by the sediment settling in and compacting around the stem. By replacing soil around the stem, it is possible to provide more opportunity for root development in the upper part of the soil profile. When replacing the soil, use a mud slurry or tamp shoveled soil around the stem to prevent air pockets.

In cobbly soils, the waterjet stinger has the same problems as most of the other techniques that one would use to plant hardwood cuttings. In our experience, the waterjet stinger will cut down through the [sic] silt layer on top of the cobble layer and stop as it hits the cobbles. In some cases, when there are a lot of fine soils around the cobbles, the waterjet will liquefy the soil around the cobbles and allow the cobbles to shift slightly so the user can get the probe around the side of the cobble. In most cases however, it is very difficult even with the waterjet to go very deeply into a cobbly soil profile. Several other methods can be successful on cobbly soils. See “The Practical Streambank Bioengineering Guide” (Bentrup and Hoag 1998) for detailed instructions on how to install these treatments.

## Safety

We would be remiss if we did not mention safety. Before the start of each planting session, safety concerns should be discussed with the planting team members. This ensures that proper safe working conditions are fresh in everyone’s mind before starting to work. Potential safety problems that might occur can be discussed. The proper response to these problems can then be considered. This helps everyone know what to do if problems actually occur.

The water coming out of the waterjet nozzles is concentrated and under extremely high pressure. If the waterjet nozzle were ever pointed at a foot or hand, it could cut through a boot or glove and into the skin. Severe damage could occur if the nozzle were pointed at the face, eyes, or any unprotected part of the body. The waterjet stinger is not a toy and should always be operated by, or at least supervised by, an experienced, mature adult. Caution should always be exercised around the pump. Inspect the hoses regularly to ensure that they are not kinked, cut, or abraded. The quick couple hose attachments should be tested several times during the operation of the waterjet stinger to ensure they are firmly attached. If for some reason the hoses are disconnected from the waterjets, shut the pump down immediately to ensure the metal tipped ends do not whip around and hurt one of the team members. It is much better to anticipate and discuss safety concerns than to heal the wounds caused by a mistake or faulty equipment.

## Summary

The waterjet stinger is easy to operate and transport. Very little training is necessary to operate the waterjet stinger. The pump intake should be placed in a fairly sediment free location in the streambed to operate properly. Hydrodrilling a planting hole with the waterjet stinger is fast and relatively splash-free. A large number of cuttings can be planted in a short period of time with very little effort compared to conventional planting methods. Planting into a hole filled with water allows each cutting to be planted directly into a wet microenvironment. The liquefied soil will settle around the cutting eliminating air pockets in the rooting zone that prevent root growth. In addition, the waterjet stinger creates saturated soil conditions around the cutting for a longer period of time. This means the cutting is in the best microenvironment to produce the largest and most desirable root mass possible, which in turn means that the establishment success rate will increase.

Overall, the waterjet stinger is relatively inexpensive when compared to other planting methods. The PMC prototype waterjet stinger costs about \$1,000 for parts (see appendix B) and labor to build it was about \$500

for a total of about \$1,500. The design layout was planned to make the entire piece of equipment as simple as possible to build and operate. The most complicated part is putting the manifold together and this only takes about a half-hour. All of the parts can be ordered or purchased locally, except the pump. An experienced machinist can build the waterjet nozzle in a couple of hours with the plans provided in this paper. Once the parts are purchased and delivered, the entire waterjet stinger can be assembled in less than a day.

The waterjet stinger is not new technology, but we have taken it to another level. We have included all the information necessary for a person to build one. After it has been built, it will take some experimentation and experience in your particular soils and conditions to figure out the best way to hydrodrill your planting holes.

More information can be obtained by calling Chris Hoag at 208-397-4133 or Boyd Simonson at 208-397-4501. For those people who have access to the Internet, e-mail messages can be sent to [choag@id.usda.gov](mailto:choag@id.usda.gov) (See figure C9.)



Figure C9—Brent Cornforth demonstrates the waterjet stinger at a training session.

## Acknowledgements

The development of the Waterjet Stinger would not be possible without the support and the generous financial assistance provided by the South Bingham Soil and Water Conservation District, Gem Soil and Water Conservation District, Squaw Creek Soil and Water Conservation District, the Camas Soil and Water Conservation District and Dick Scully (Regional Fisheries Biologist), Southeast Region, Idaho Department of Fish and Game.

### Literature Cited

Andrews, D. 1999. Personal Communication. Denis Andrews Consulting, Manitoba, Canada. Bentrup, G. and J.C. Hoag. 1998. *The Practical Streambank Bioengineering Guide — A User's Guide for Natural Streambank Stabilization Techniques in the Arid and Semi-Arid Great Basin and Intermountain West*. USDA NRCS Plant Materials Center, Interagency Riparian/Wetland Plant Development Project, Aberdeen, ID.

Drake, L and R. Langel. 1998. Deep-planting willow cuttings via water jetting. ASCE Wetlands Engineering & River Restoration Conference, Denver, CO. March 22-27, 1998.

Hoag, J.C. and D. Ogle. 1994. *The Stinger, a tool to plant unrooted hardwood cuttings of willow and cottonwood species for riparian or shoreline erosion control or rehabilitation*. USDA Natural Resources Conservation Service, Idaho Plant Materials Technical Note No. 6, Boise, ID. 13 pp.

Hoag, J.C. 1993. *How to plant willows and cottonwoods for riparian rehabilitation*. USDA Natural Resources Conservation Service, Idaho Plant Materials Technical Note No. 23, Boise, ID. 12 pp.

Oldham, J.A. 1989. The hydrodriller: an efficient technique for installing woody stem cuttings. Society of Ecological Restoration and Management annual meeting, Oakland, CA. Jan. 16-20, 1989. 6 pp.



## APPENDIX C-A

### Detailed Drawing of the Waterjet Nozzle Tip From Drake and Langel (1998).

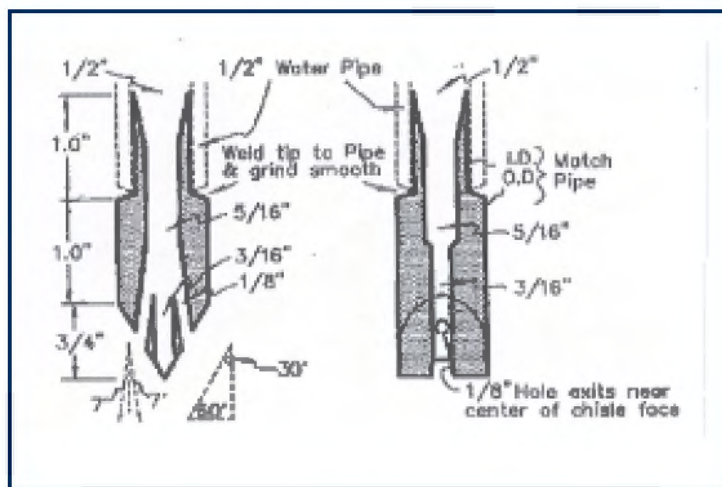

Figure C10.



Figure C11.



Figure C12.

Pictures of the stainless steel nozzle that was welded to 1/2-in steel pipe. [See figures C10, C11, and C12.] The stainless steel is expected to increase the life of the waterjet. A machinist built the pipe, handle, and nozzle as a single unit. The ball valve is added by the end user.

## APPENDIX C-B

### List of Materials for the Entire Waterjet Stinger.

[Prices updated periodically; check Web site] [See figures C13 and C14.]

Name of item	Location	Number	Cost
<b>Manifold parts</b>			
1½-in. pressure relief valve	Manifold	1	\$120.00
2-in. galvanized metal tee	Manifold	1	7.00
1¼-in. galvanized metal tee	Manifold	1	4.00
2- to 1½-in. galvanized metal reducer	Manifold	1	1.64
3-in. long, 1½-in. galvanized metal nipple	Manifold	1	1.59
3-in. long, 1¼-in. galvanized metal nipple	Manifold	1	1.19
2- to 1¼-in. galvanized metal reducer	Manifold	1	3.00
1¼- to 1-in. galvanized metal reducer	Manifold	2	5.00
2-in. male pipe to 2-in. male coupler nipple	Manifold	1	4.75
1½-in. male pipe to female cam lok coupler	Manifold	1	8.00
1- to ¾-in. brass pipe to hose adapter	Manifold	2	6.58
¾- to ¾-in. male hose to male hose adapter	Manifold	2	1.89
		<b>Total:</b>	<b>164.64</b>
<b>Suction and Bypass parts</b>			
1¼-in. plastic hose for discharge	Bypass	20 ft	30.00
1½-in. female cam lok to 1¼-in. male hose shank			
2-in. male pipe to male hose coupler	Screen	1	5.80
2-in. plastic hose for suction for intake	Intake	20 ft	40.00
2-in. male hose to female king nipple hose cam lok coupler			
2-in. hose clamps for plastic hose	Intake	3	2.70
		<b>Total:</b>	<b>120.20</b>
<b>Waterjet parts</b>			
¾-in. ball valve	Probes	2	10.00
¾- to ½-in. elbow reducer	Probes	2	3.00
½- to ¾-in. metal reducer	Probes	2	2.00
1- to ¾-in. brass pipe to hose adapter	Probes	2	6.58
¾-in. male hose to ¾-in. male hose adapter	Probes	2	2.00
Female brass garden hose quick couplers	Hose	4	11.00
Heavy duty ¾-in. garden hose (100 psi-rated)		200 ft	120.00
Waterjets, manufactured by machinist		2	180.00
		<b>Total:</b>	<b>334.58</b>
<b>Waterjet pump</b>			
2-in female pipe to male hose king nipple	Pump	1	5.30
2-in female pipe to female hose-cam lok coupler Pump		1	15.00
Pump and Motor (excludes freight)		1	495.00
Roll cage for pump		1	65.00
		<b>Total:</b>	<b>595.30</b>

**Total cost of parts (as of March 2001) \$1,199.72**



Figure C13—Waterjet Stinger manifold.



Figure C14—Garden hose quick coupler manifold.

## APPENDIX C-C

### High Pressure Gasoline Powered Pump Specifications (See figures C15 and C16)



Figure C15—Note: Metal cage around the pump and motor was purchased separately.

#### Specifications

- ◆ 5-HP Gas powered High pressure pump
- ◆ 7,200 GPH, 200-foot head, 88 psi max
- ◆ Vertical lift 18 ft
- ◆ Self priming pump with 2-inch NPT suction and discharge ports
- ◆ Aluminum closed impeller
- ◆ Cast aluminum housing
- ◆ Cast Iron volute
- ◆ Built-in check valve
- ◆ Water and trash pump strainer, 2 inch, included
- ◆ 64 pounds

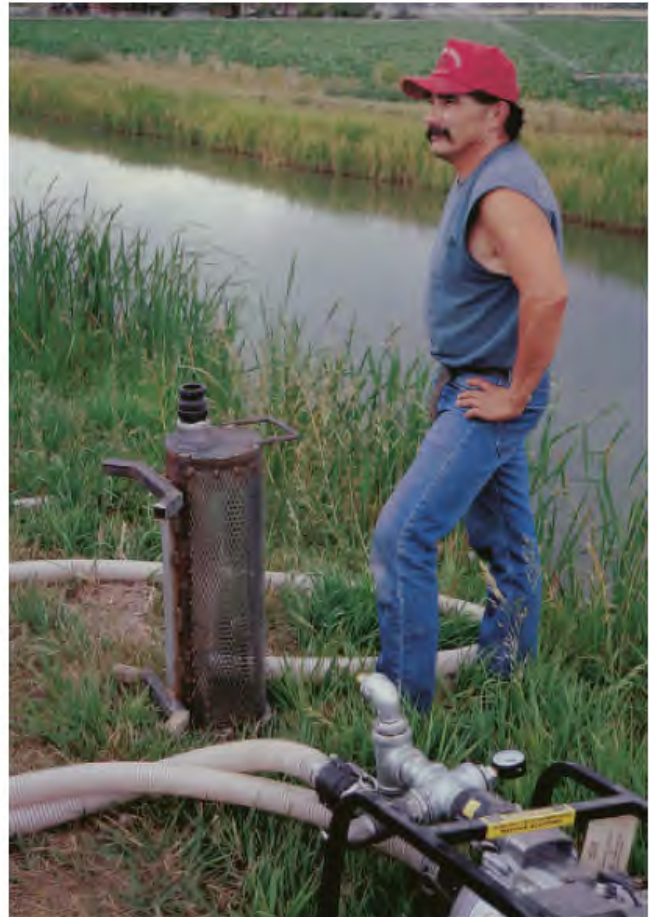

Figure C16—Boyd Simonson with large trash strainer

**Note:** Trash Strainer shown was built for large stream systems so it could be perched above the stream bottom and was heavy enough not to move with the stream current. The pump was shipped with a small strainer that attaches to the end of the suction hose for use on smaller stream systems (Not shown).



## APPENDIX C-D

### An Illustrated Diagram of an Operating Waterjet Stinger

The waterjet stinger [figure C17] is sitting on a large 6-wheel ATV during a workshop in Lapwai, ID, on Little Lapwai Creek. The 6-wheel ATV is larger than what is necessary to transport the waterjet stinger. The track option for the ATV is not necessary.

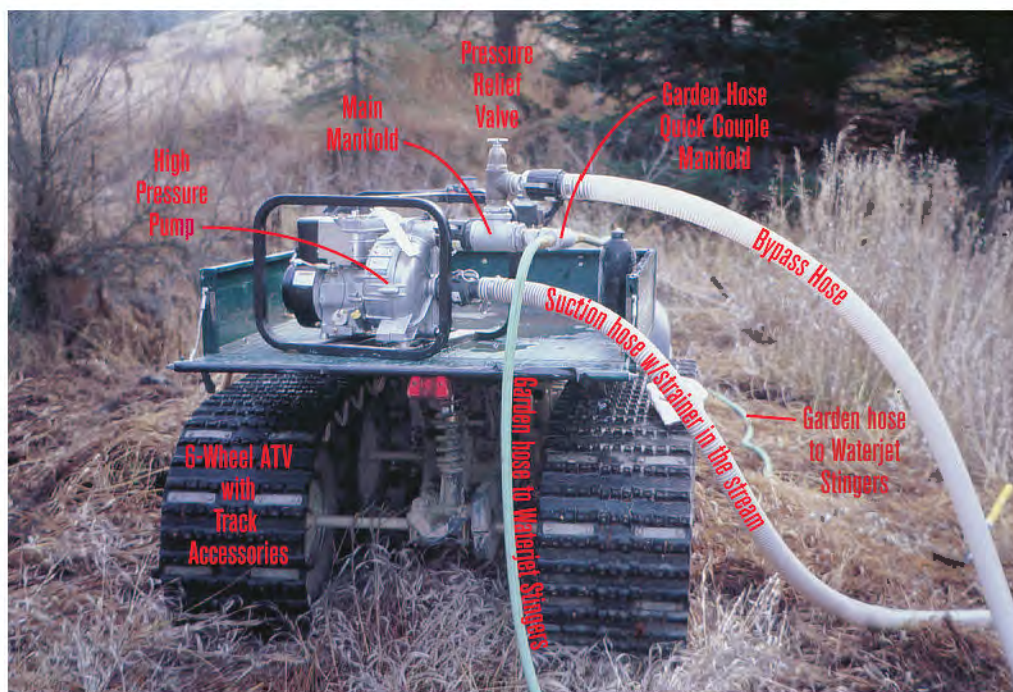

Figure C17-6-wheel ATV with track accessory

# APPENDIX D

## Pest and Weed Control

### Pests

A number of products on the market can protect seedlings from being eaten by mammals and insects. Screen will keep some insects away. Plastic tubes and/or wire will prevent or discourage browsing. Tree mats and brush blankets® are both designed to cover the ground directly around the plant to discourage competing weed growth. Mats or blankets may be crafted of cardboard. See figure D1.

Products can be found on the Web through a search engine; use the following key words to search: tree mat, tree guard, brush blanket, tree shelter.

Use 3- to 4-foot plant collars or tubes on trees and shrubs if browsing animals and rodents are a problem. See figure D2. Tubes are made of translucent material or of mesh. Growing tubes generally should not be taller than 3 to 4 feet. The tree becomes very spindly when a taller tube is used. If the tree still needs protection, construct a 6-foot-tall wire cage for the plant that is wide enough to avoid interference with its branch structure. See figure D3. At some point, the tree will have to be without protection. Depending on the species, it may not matter that it is browsed when only 3 feet tall.

The “planting collar” was developed at the University of California, Davis. See figure D4. A description from Pacific Gas and Electric says, “The planting collar is used to aid establishment of adapted woody plant species in non-irrigated extensive natural and landscaped areas. It is most effective at difficult [to reach] disturbed sites with well-drained soils where plants are to

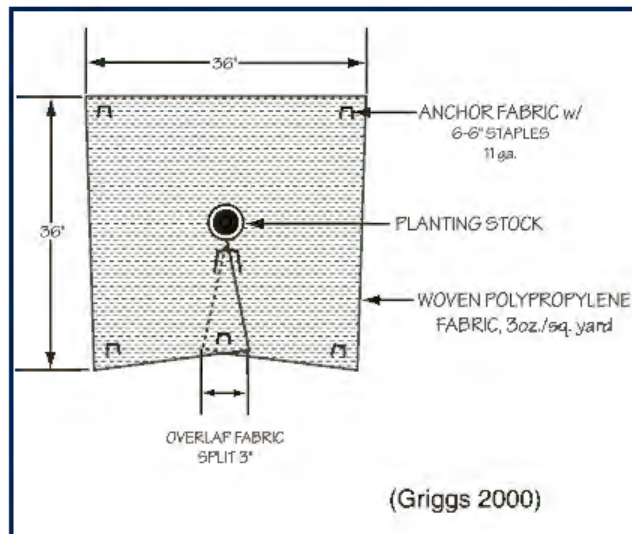

Figure D1—Plant or tree mat

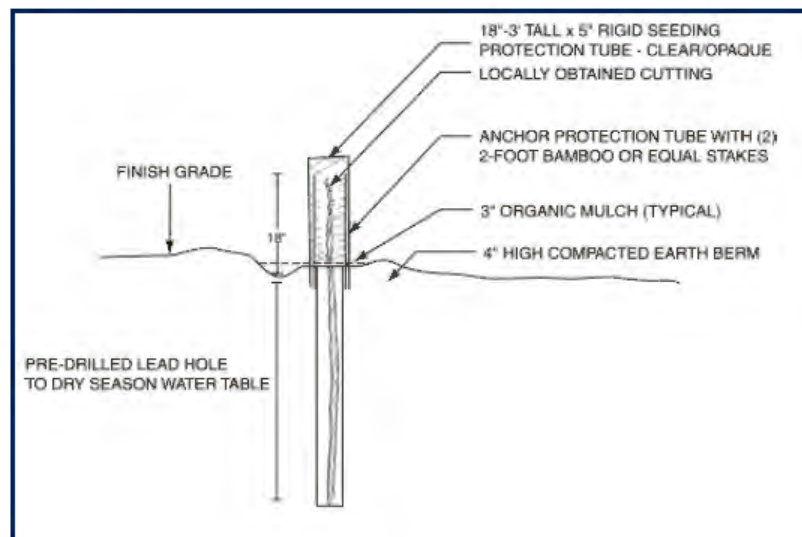

Figure D2—Plant tubes

survive and grow under the existing environmental conditions” (Griggs and Stanley 2000). The collar increases the soil temperature to promote root growth and protects roots. It also concentrates moisture at the root zone. The attached screen protects against browsing and insect infestation during the first growing season. The collar is not appropriate in clay soils because of frost heaving or on flood plains (Griggs and Stanley 2000).

A chicken-wire basket can be installed around the roots of a plant to protect against rodents. Be sure the soil has a high enough mineral content to rust the baskets or the baskets will girdle the plants and kill them. Do not use stainless steel wire. (Flooding kills some

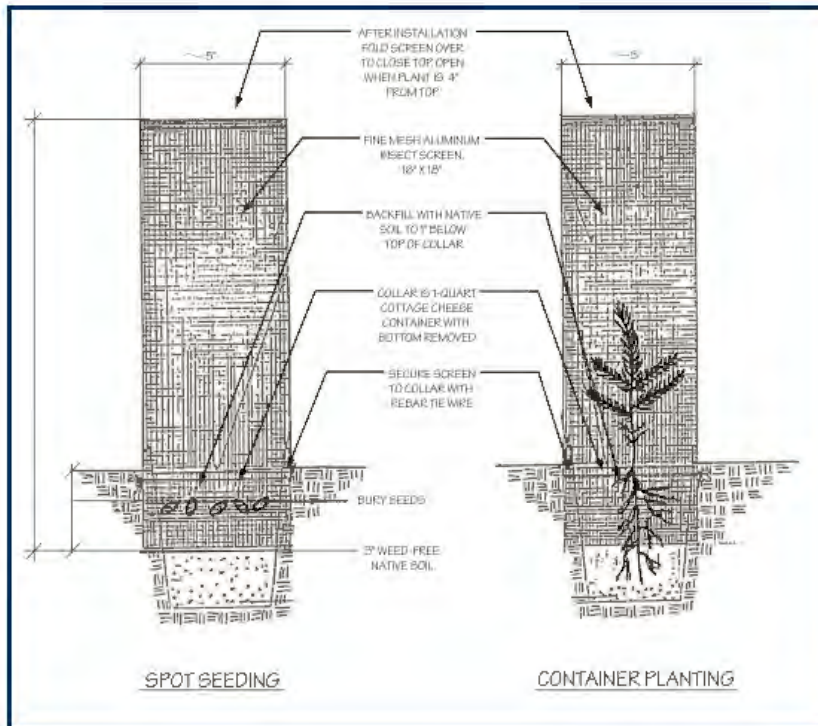

Figure D3—Collar and screen method

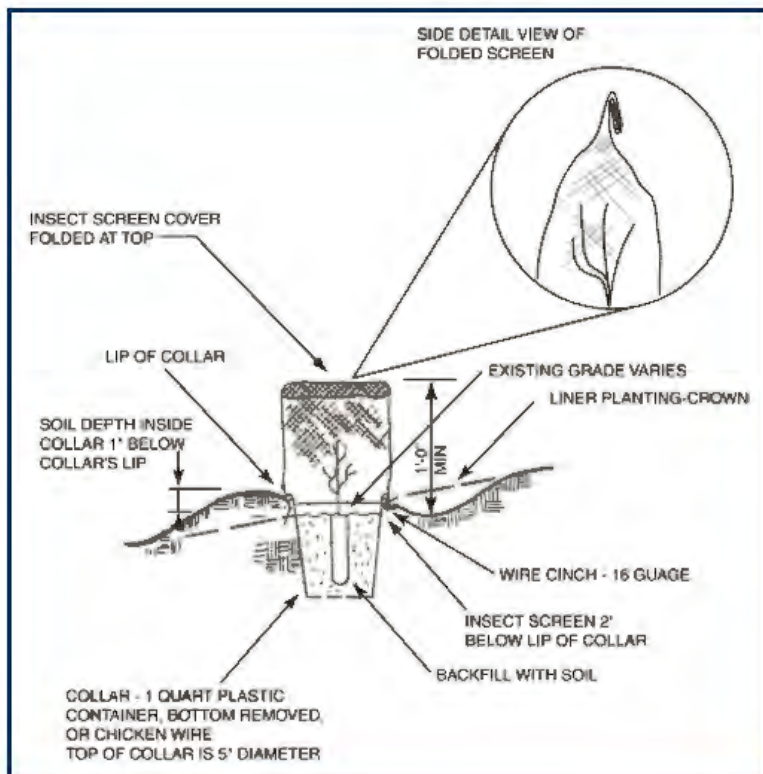

Figure D4—Liner planting with planter and screen

rodent populations. If an area floods near planting time, rodents may not be a problem for a while.)

## Weeds

Generally, weeds outcompete plants by using the soil moisture (Lardner 1999). One of the objectives in weeding is to shift the balance to more native plants and fewer weeds. This shift allows native plants a chance to grow and to take over. Mulch is a good medium to suppress weeds without resorting to herbicides; there will always be some weed growth while the plants are becoming established. Some weed growth can hide the new plants from browsing animals.

Weed before site work begins. If there are few weeds, dig them out; otherwise use the herbicide Rodeo® where appropriate. Rodeo® breaks down faster than other herbicides, and it has been approved by the EPA for use near water (Roundup® has not). Begin weeding (when no crust is present) as soon as the weeds appear. If possible, find the source and eradicate it.

If you choose to pull up weeds, know when they will drop their seeds and avoid disturbing them during this period. Disturbance may cause seeds to disperse farther than usual. Before seed heads have opened, cut them off and place them in a plastic bag. Ask your State's weed abatement office for advice on destroying weed seeds.

The Bradley method for eliminating exotic plants advocates pulling errant weeds and those on the edges of a mixture of native and exotic plants. Although labor intensive, this technique has been successfully used. For more information see: <http://www.edgehill.net/bradley.htm>

# APPENDIX E

## Split Rail Fences and Barriers

From memo to Park Superintendent written by Kari Bown 1990.

The National Park Service [NPS], at Yosemite National Park published the following split rail fence designs in 1990. The fences were to be made from hazard incense cedar trees to keep the costs down, but fences may be made from whatever is appropriate on a particular forest. The split rail and post diameters may vary depending on the timber available and on information in The Built Environment Image Guide.

[A caution was included in the design:] . . . concern was raised that this fence might get disassembled for firewood in campground areas. It might be worthwhile to build a pilot fence near one . . . to examine the feasibility of this application.

The National Park Service has built some fences out of recycled plastic lumber. [A number of companies manufacture plastic lumber out of recycled plastic. Post size can be customized, fabricated in a wood grain, and dyed to match other lumber. Yosemite and Yellowstone National Parks use plastic lumber for posts on their post-and-rail fences. The Walt Disney Company uses plastic lumber throughout its theme parks to simulate many different woods and bamboos.

Plastic lumber has some advantages. It does not rot, stain, or make good firewood, and it is not attacked by bugs. Make sure the plastic lumber is 100 percent plastic with no wood additives. One company guarantees it for 50 years. It costs more initially, approximately \$53 for one 4 by 4-inch by 6-foot piece. If plastic lumber is a viable option, seek a partnership with a company to eliminate or reduce the initial investment.]

For instructions and drawings for building a buck-and-pole fence, see [www.fs.fed.us/r6/uma/asp/buckandpole.htm](http://www.fs.fed.us/r6/uma/asp/buckandpole.htm)

### Double Post/2 Rails

This fence looks like the rails are stacked between posts. They [sic] rails are “pinned” to the posts with rebar. Two feet of each post is buried. [See figure E1.]

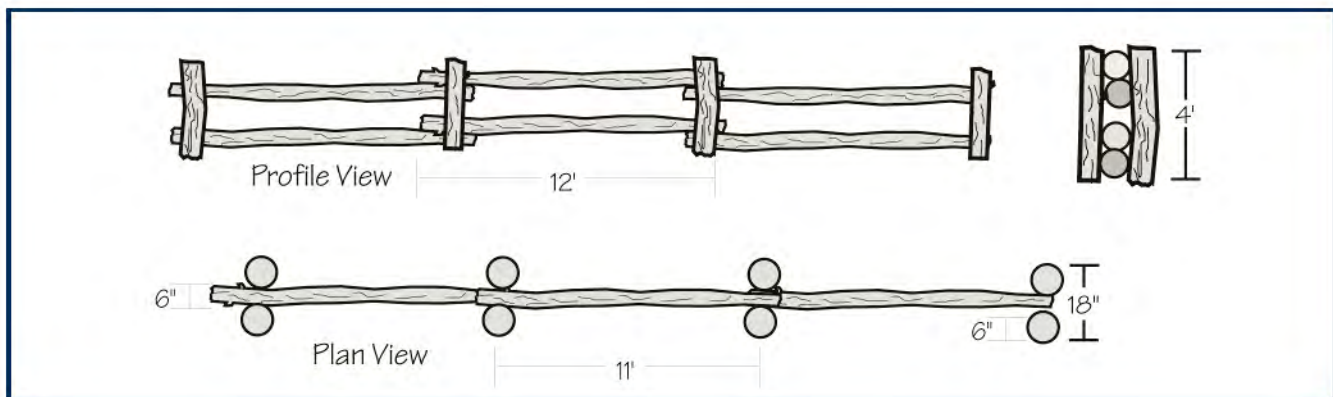

Figure E1—Double post 2-rail fence.

Materials Required: 6-ft posts  
12-ft rails  
9 by ½-in rebar “pins” [spikes]

Tools Required: portable generator, drill motor with 12-in long ½-in bit, posthole digger, level, line, hand sledge, tape measure, hatchet, pick

### Double Post with Stacked Rails

The rails are stacked between two posts. The rails are “pinned” to the posts with rebar. Two to 3 feet of each post is buried. [See figure E2.]

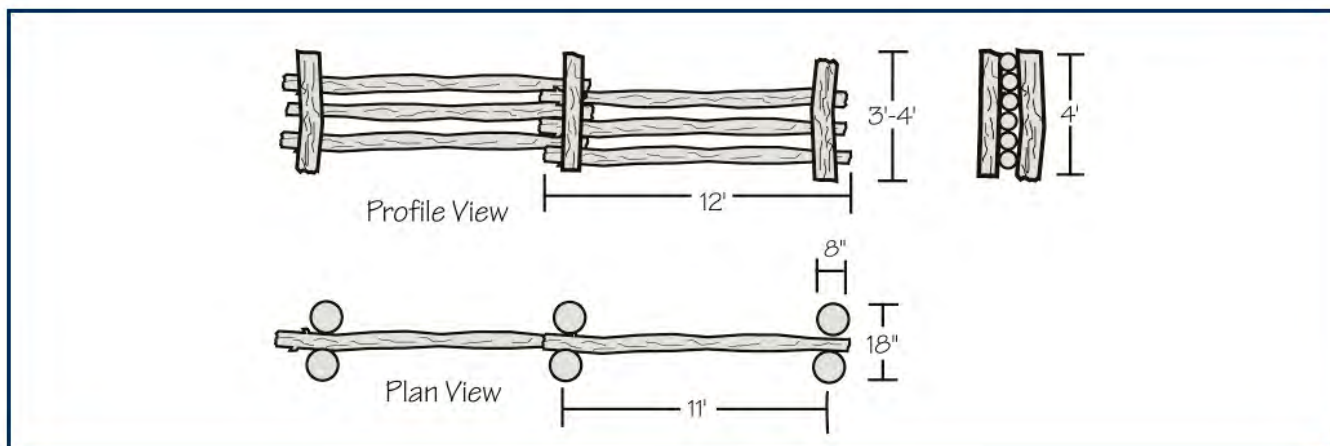

Figure E2—Double post with stacked-rail fence.

Materials Required: 6-ft posts  
12-ft rails  
6-in spikes

Tools Required: portable generator, drill motor with 12-in long ½-in bit, posthole digger, hatchet, hand sledge, level, line, tape measure, pick

### Over/Under and Parallel Zigzag

There are two types of zigzag fences. They are differentiated by how the rails are stacked.

This fence takes a 4-foot swath. Because it does not require any fenceposts, it is perfectly designed for archeological sites. Depending on the message desired, it could be two, three, or four rails high. This is an easy fence to build well, requiring minimal skills.

A wide range of rail size and quality can be used. It is not appropriate on steep slopes or where only a narrow swath is available. [See figures E3, E4, and E5.]

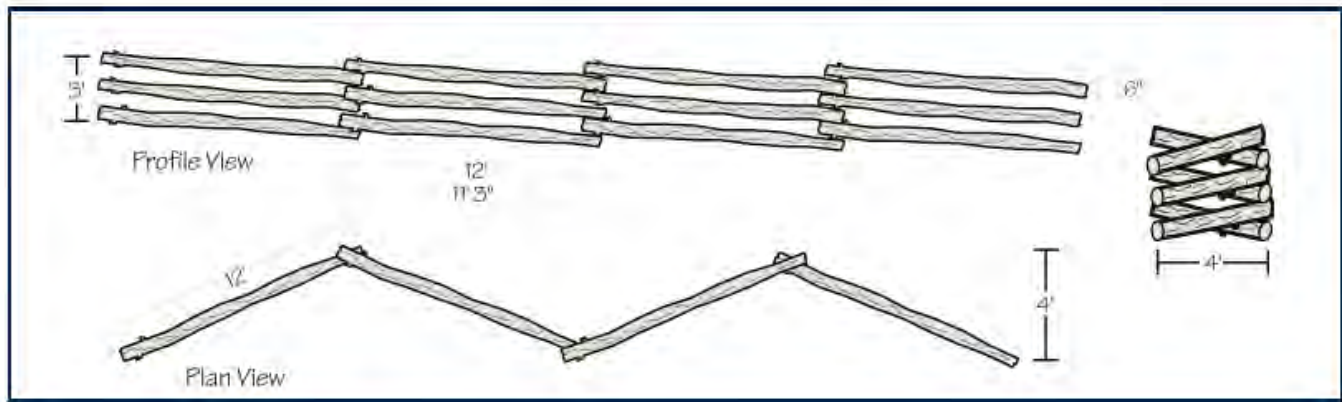

Figure E3—Under/over zigzag fence.

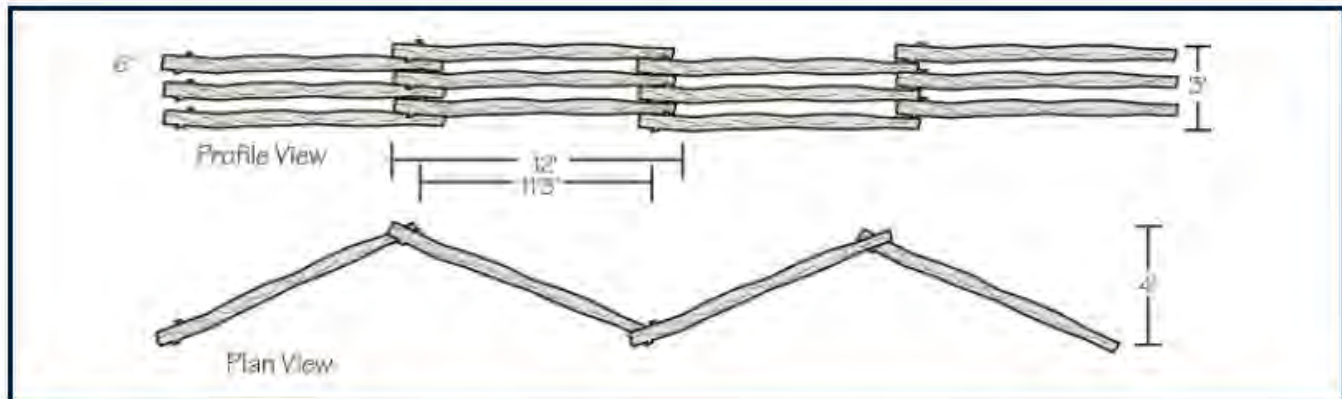

Figure E4—Parallel zigzag fence.

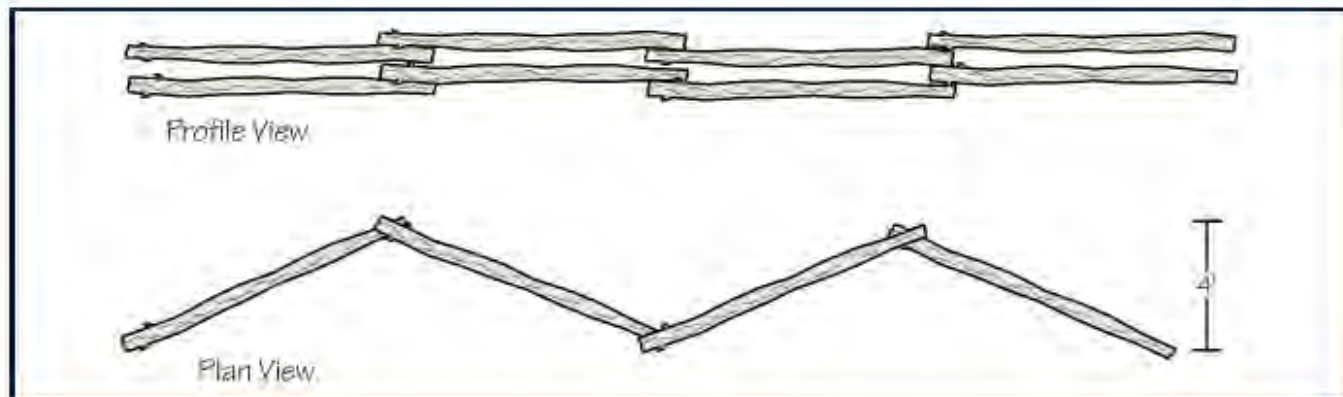

Figure E5—Short zigzag fence.

Application criteria: oak woodlands  
 fern understory areas  
 riparian areas  
 archeological sites

Materials required: 12-ft rails  
 6-in spikes  
 3-ft rebar

Tools required: hand sledge, tape measure line, drill with a long ½-in bit

The design is securely spiked together, but concern was raised that this fence might be disassembled for firewood in campground areas. It might be worthwhile to build a pilot fence near one campground to determine the feasibility of this application.

## Hetch Hetchy Design

Written by Yosemite staff.

This style is a single post-and-rail construction using hand-split cedar. The hand-split treatment gives it a rustic appearance and cedar will hold up for many years due to its rot resistance. It is sturdy, low-maintenance fencing that is relatively easy to install.

The specifications for the split rails and posts are important to attaining a quality finished product. A minimum rail size of 4 by 5 inches and 6 by 8 inches for the posts is essential for the sturdy construction required at high visitor-use areas and or heavy snow-load locations. The posts should be 60 inches long with approximately 29 inches in the ground for optimal stability in varying soil types. The ideal rail length is 12 feet where snow loading is not an issue. This minimizes the posts required, however, it increases the material costs due to higher prices for 12- versus 10-foot rails. When snow loading is present, the ideal rail length is 6 to 8 feet, depending on snow depth. The materials should have a minimal amount of rot or bug damage.

The posts and rails are purchased without any tapering or holes for fitting the fence together. The finish work for the rails is done with a small chainsaw to taper the ends. The posts have rectangular holes to allow the rails to fit snugly. To fabricate the posts this way requires some specialized tools. Use a Milwaukee 3-foot self-feeding drill bit with a 5½-foot extension and a drill press capable of a 9-inch boring depth. The drill, a Milwaukee electro-magnetic portable drill press, is ideal for field use with sufficient power to go through 8 inches of wood. Specialized sawhorses for chain saw work on the rails and a custom-built stand for the drill press is also necessary. A 2-inch wood chisel will square up the notches left from drilling. [See figures E6 and E7.]

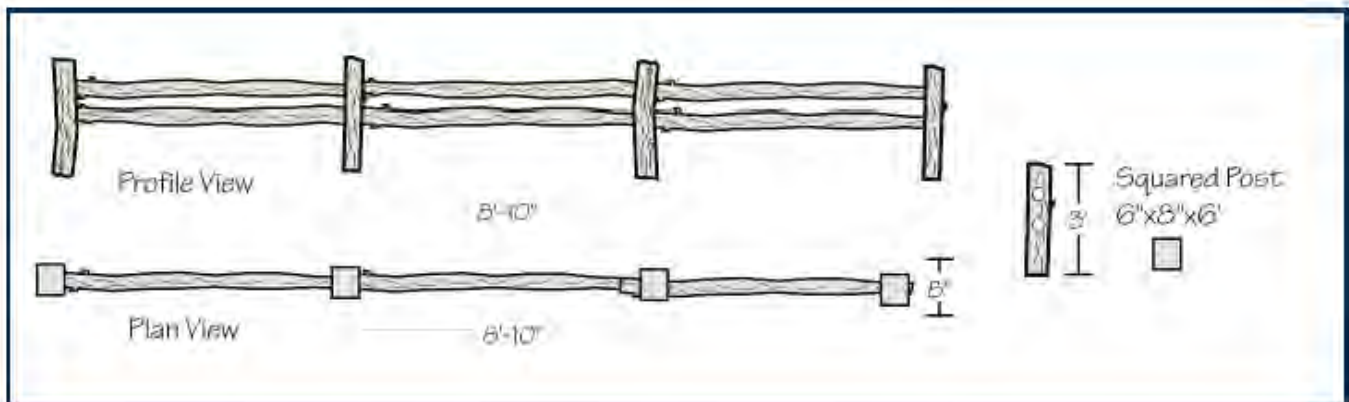

Figure E6—Hetch Hetchy fence.

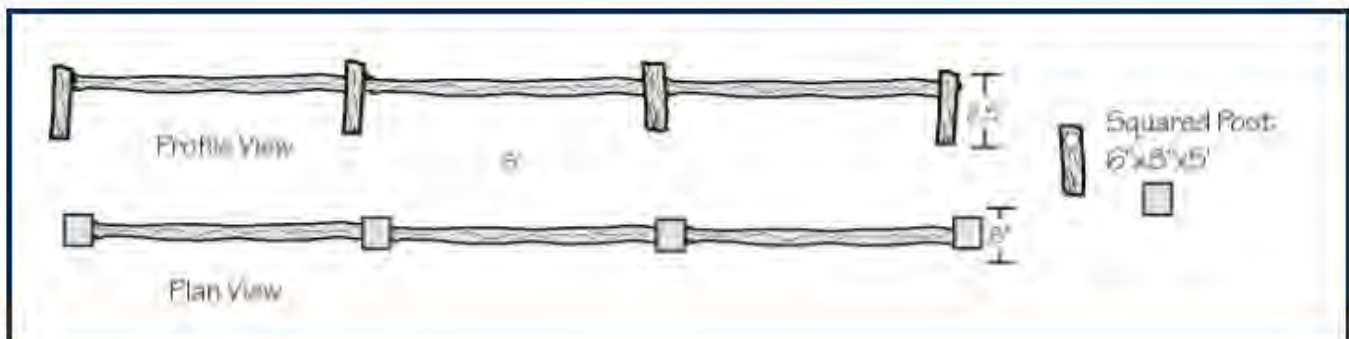

Figure E7—Short Hetch Hetchy fence.



Application criteria: timbered areas  
steep slopes  
along meadows (short version only)

Materials required: 6- by 8-inch by 6-foot squared posts  
10-foot straight rails

Tools required: chain saw, level, line, posthole digger, tape measure, pick, Milwaukee 3-foot self-feeding drill bit

### Wood Barrier Post

This substantial wood barrier is made of telephone poles. It was developed by the California Department of Transportation (Caltrans 1994 page 7-36, as seen in Griggs and Stanley 2000). See figure E8.

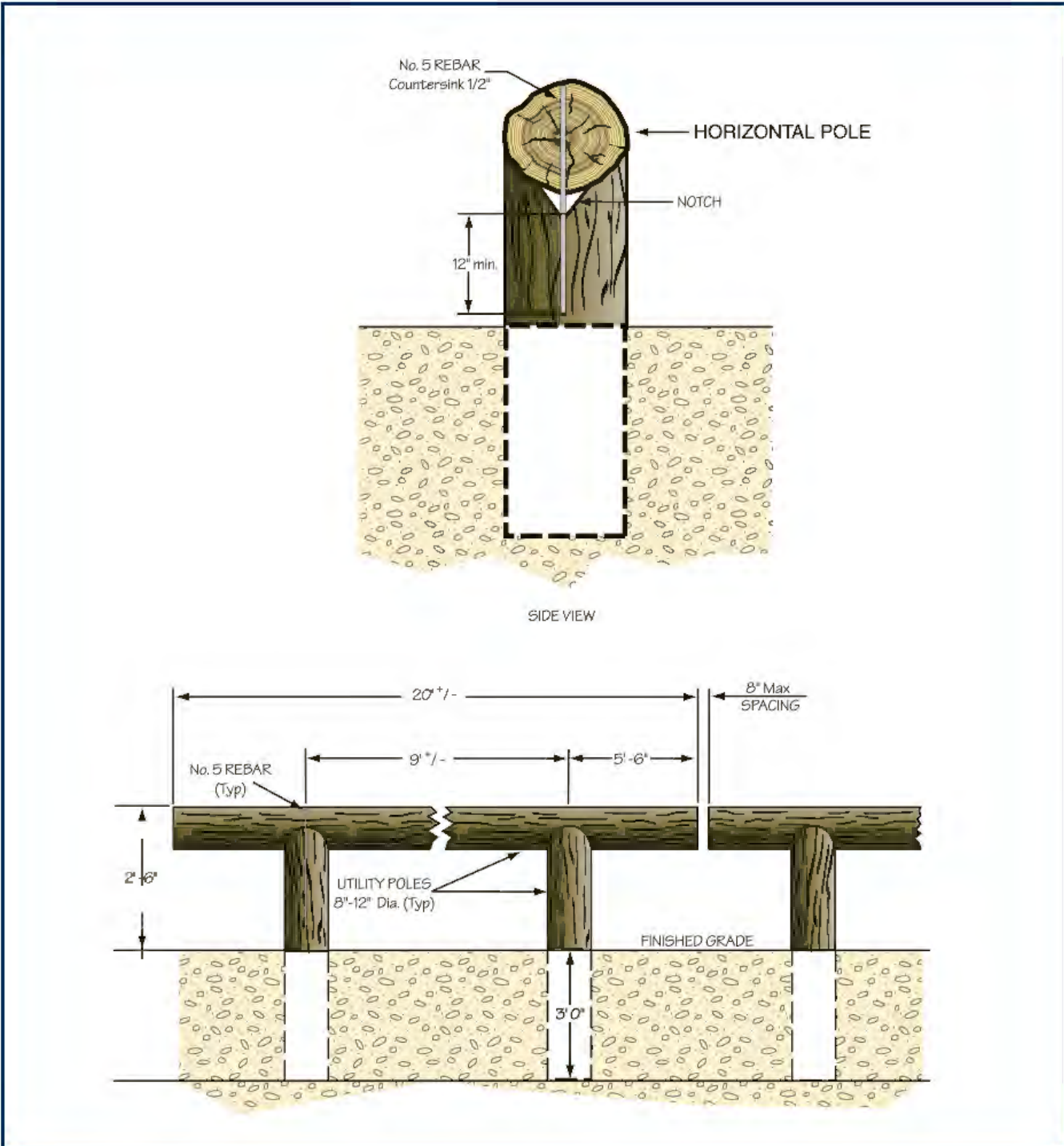

Figure E8—Wood post barrier.

## Rock Barrier

Indigenous rock can serve as barriers where appropriate. Do not import rock to an area where large rocks are not part of the natural landscape. To create an effect with rock that blends into the landscape, it is important to mimic nature; plant rocks in groups of two, three, or four, varying spaces between them. Rock doesn't naturally occur regularly spaced. One-third of the rock is buried. Placing rocks along roadsides prevents people from parking off the pavement and/or outside of designated parking areas. See figure E9.

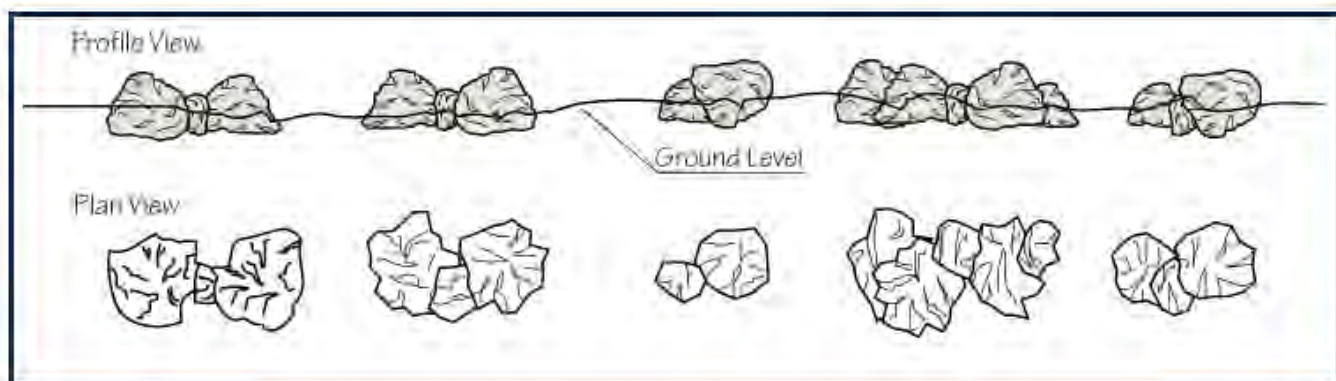

Figure E9—Rock barrier.

## APPENDIX F

### Campsite Monitoring Instructions

Compiled by Chris Smith, Lead Wilderness Ranger, Petersburg Ranger District, Tongass National Forest. Based on publications of David N. Cole and Jeffery L. Marion.

#### Introduction

A campsite is defined as any area exhibiting evidence of recreational use, either through day or overnight activity. Evidence of this activity might include, but is not limited to trampled vegetation, fire rings, human waste, broken tree limbs, and litter. In general, areas of untrampled vegetation will separate sites, but, in some instances, individual sites may include islands of undisturbed vegetation. These islands are not considered part of the total area and are also disregarded when conducting the impact analysis. Careful attention to discrete changes in vegetation and soils will be necessary to differentiate one site from another within a camp area. Measurements will only be taken in areas that are above the high tide line. Upland areas that are subject to physiographic changes from season to season should be excluded. These sites can include gravel washes, gravel bars, and nonvegetated alluvial fans.

#### Getting Oriented

When you arrive at a site, take stock of the area. Walk around the site and determine, through careful observation, the boundaries of the site. Note areas of absent, flattened, or damaged vegetation and contrast these with areas that remain pristine. On rare occasions, when an area may be naturally devoid of vegetation, attention to discrete changes in organic litter will be necessary to delineate site boundaries. And on some occasions, in a pristine area, some damage to vegetation will be from animals, evidenced by scat, hair, matted or browsed vegetation—do not confuse this with recreational use.

#### Determine Site Boundaries

The **Variable Radial Transect Method** will be employed to measure the dimensions of sites (Marion 1991). When walking the boundary of a site, place pieces of flagging or flag pins at various points along the boundary. We have allowed for the use of up to 15 boundary points, which should *reflect* the actual

boundaries of the site, and will form a polygon from which the area of the site can be calculated. In many instances you will not require all 15, but in others it will be necessary to balance areas of use and non-use to most effectively use the points. (Refer to Illustration 1.0.) [See figure F1.]

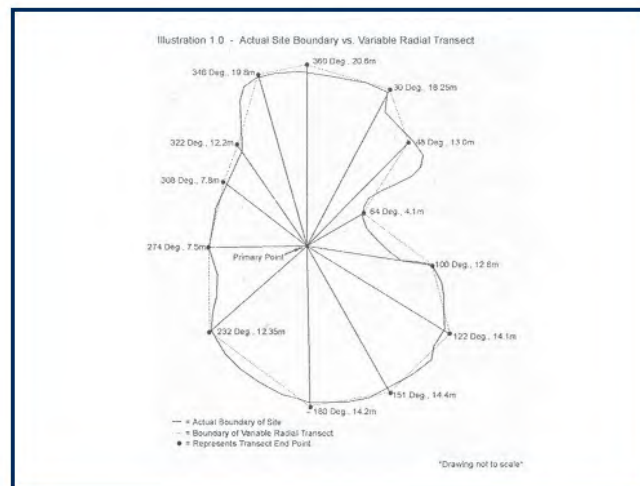

Figure F1.

#### Locating the Primary Pin

After selecting the boundary points, locate a primary point from which bearings and distances can be measured to boundary points (transects). [See figure F2.] Generally, the primary point will be located in the center of the site—make sure that it is placed in a position where most boundary points can be seen. For the time being, place a spike, which will function as the primary point, in the ground but do not bury it—all of your transects (measurements) will radiate from this spike. Reference the primary point with three reference points, which can later be triangulated when remeasurement occurs. Choose reference points that are not only unique to the site, but also not easily removed, damaged, or destroyed—large rocks and trees work well. Describe the reference points in as much detail as possible. If trees are chosen as reference points, then record the [diameter breast height] dbh, indicate the species, and note any distinguishing features that might aid in remeasurement. If a GPS unit is available, record the location of the primary pin. By photographing the reference points, carefully describing the photo points, and recording the location of the primary pin with a GPS, you will go a

long way toward ensuring that the site will be relocated and effectively remeasured in the future.

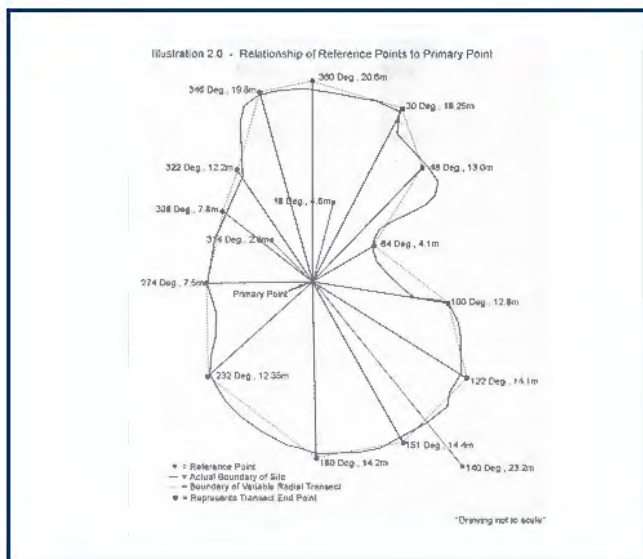

Figure F2.

After choosing and describing your reference points, record the distance and bearing from the primary point to the reference points. Make sure that the tape is kept level; record distances from the dbh of the tree and the face closest to the primary pin. Taking these steps will ensure a level of consistency and reduce the range of variability in the measurements over time.

### Measure Site Boundaries

From the primary point, measure your transects. Starting from the boundary point closest to north, work your way around the site in a clockwise direction. Making sure that the tape is kept level and the end over the primary pin, shoot the bearings and record the distances to the site boundary points, which are marked with flagging. **It's essential that all measurements and bearings are doublechecked, for inaccurate measurements will not only distort data, but also make an accurate remeasurement of the site impossible.** If the tape measure must bend around a tree or other obstruction (rock, structure, etc.) to complete a measurement, then take the shortest distance around the obstruction. Do not remove any boundary flag until you have completed the survey and rechecked any doubtful measurements.

### Measure Undisturbed Islands

Due to various ecological or physiographic conditions, many sites include islands of undisturbed vegetation that have escaped impact. These islands of trees, shrubs, plants, rocks, or hummocks are often too difficult for the visitor to utilize as campsites. If an undisturbed island is encountered, indicate in the transect notes at what distance from the primary point it was encountered and then where the transect departed. (Refer to Illustration 3.0.) [See figure F3.] In the office, by superimposing a polygon upon the island, the area can be calculated and subtracted from the area of the impacted site.

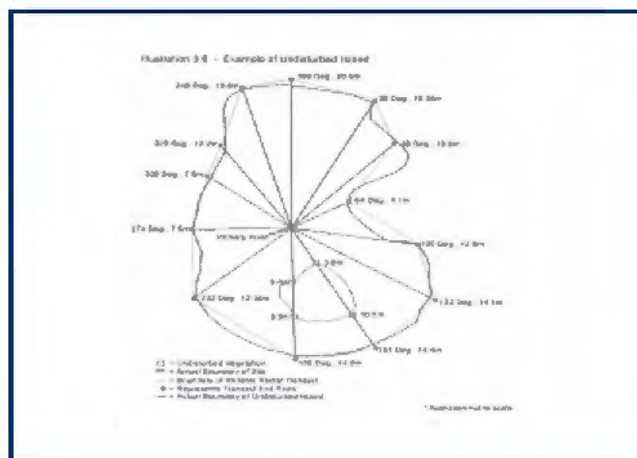

Figure F3.

### Completion of Measurement

At this point it is appropriate to bury the spike. Make sure that the spike is driven 4 inches below the surface of the site; this allows for easy relocation but reduces the chance that it could be removed.

### Site Remeasurement

When the time comes to remeasure a site, make sure that it is measured at the same time of the year. [See figure F4.] To relocate the site, it will be necessary to use aerial photos, GPS coordinates, the legal description, photo points, and reference points to locate the primary point, which is buried beneath the ground. The first four should get you close to the point, but the reference points should help narrow your search. After locating the reference points, shoot the three back bearings and measure their respective distances to the primary point. To confirm the location of the

primary point, it will be necessary to carefully dig, using a trowel, until the spike is found.

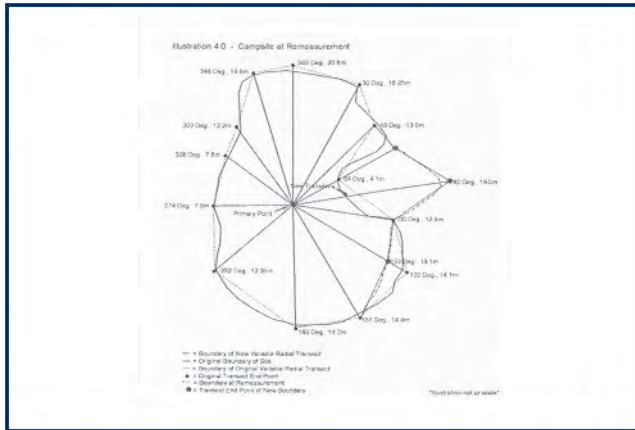

Figure F4.

Once the primary point is relocated, then the boundary of the site can be laid out using the original transect information. Place flagging or flags at the end of each transect. If the boundary of the site has changed, then it will be necessary to adjust the boundary. Place a different colored piece of flagging or pin on the new boundary point. Make sure that the boundary is carefully evaluated, do not change the boundary points and bearings unless necessary. On a new form, in the “boundary point” section, record any new boundary points and re-record any old boundary points that were retained. Evaluate all inventory and impact parameters within the new site boundaries. Repeat any photo points and add new ones if necessary.

**Inventory and Impact Form Directions**

1. **Inventoried by:** List the persons responsible for the inventory.
2. **Date Inventoried:** This is the date the campsite was assessed.
3. **GPS Coordinates:** After entering the points into the GPS unit, determine the longitude and latitude in the office.
4. **Map Coordinates:** Record the location of the site on a topographical map by township, range, section, and quarter section. If several sites are located within a cluster, then draw

lines away from these points so that their names can be clearly read. If it will assist in the relocation of the site, sketch the relationship of these sites to one another, on the back of the inventory form. Attach a copy of the topo and sketch (if needed) to the monitoring form.

5. **Map Name:** List the map name (Ex. Petersburg D-2).
6. **Camp Name/Number:** Use the most common name associated with a local area or topographic feature. For example, two sites located in Rowan Bay could be referred to as “Rowan Bay 1,” “Rowan Bay 2,” but two sites along Rowan Creek, which feeds Rowan Bay, might more appropriately be named: “Rowan Creek 1” and “Rowan Creek 2.”
7. **Beach Aspect:** Indicate the aspect of the beach with a compass direction.
8. **VCU:** In the office, after the monitoring trip, locate the site within its appropriate *value comparison unit* [specific to R10; R8 calls them compartments] and list this number within the box provided on the Monitoring Form.
9. **Island:** Indicate the applicable area within the appropriate box.
10. **Aerial Photo:** In the field, place a dot and the name of the site on an aerial photo; this will assist future personnel with relocation of the site. In the office, make a color copy of the aerial and attach to the Monitoring Form.
11. **Site Location Description:** Describe the site location using geographic features (such as points, bays, inlets, creek mouths, islands, harbors, coves, lakes, creeks, aids to navigation, and other distinctive or recognizable features or landmark(s) and measurements. Measurements can be estimated by reading the map (especially in the case of longer measurements), taken with a tape, or paced. Know the length of your pace and periodically verify it so that you can make accurate measurements. Remember: Remeasurement of the site might not occur for several more years, so an accurate description of the site is essential.

- 12. Vegetation Type:** Select the type that most clearly reflects the characteristics of the site.  
Example: If the site is located on the beach but in the grasses along the beach fringe, then place a mark in “beach (vegetated).”
- 13. Photo Point Descriptions:** Select photo points that will indicate changes to the site over time and assist relocation. When documenting photo points, indicate what type of camera, film speed, and lens was used in the “photo point descriptions.” Take photos that not only include the site, but also broader views of the surrounding area. Avoid close up shots because they lack landmarks, reveal little of the site, and make relocation difficult. Select prominent landmarks (a unique tree, rock, or feature), reference points, or boundary points. To help replicate the photo point, indicate the compass bearing in the “photo point descriptions.” Thoroughly describe the photo point and its view of the site and surrounding country, if applicable. Taking a photo point of another photo point can also assist relocation. Develop a system to keep track of your photos, so that after your film has been processed you can properly label the backs of your photos. The name of the site, the date, and the number of the photo point should be marked on the back of the photo. If your camera has a date and time setting, activate it to help identify your photos.
- 14. Exotic Plants Present:** Familiarize yourself with plants considered exotic to (your) Petersburg Ranger District. Record whether exotic species are present and, if they are, list the names of the species. Several of the more obvious species include: Conunion Dandelion (*Taraxacum officinale*), White Clover (*Trifolium repens*), . . . .
- 15. Substrate of the Landing Area:** Indicate the appropriate substrate in the box provided.
- 16. Substrate of the Camping Area:** Indicate the appropriate substrate in the box provided.
- 17. Vegetative Ground Cover—Onsite/Offsite:** Vegetative ground cover is defined as any live moss, plant, shrub, or tree under 2 meter in size. Using the scale provided, estimate percentage of cover onsite (excluding the undisturbed islands) and in the offsite control. When selecting an offsite control area, make sure that the site is similar in slope, aspect, tree cover, and species composition. Reference the coverage class chart, included in appendix 1.0, to assist with the visualization of these percentages.
- 18. Organic Duff—Onsite/Offsite:** Organic duff is defined as any organic debris such as needles, leaves, twigs, etc., as, well as the thick organic mat found in many sites, but not covered by vegetation. Using the coverage class chart, estimate the percentage of organic duff onsite and in the offsite control. Make sure that the undisturbed islands are excluded from these calculations.
- 19. Mineral Soil Exposure Onsite/Offsite:** Defined as any nonorganic soil, mineral soil includes bedrock, cobble, sand, and soil. This is mineral soil not covered by either vegetation or organic duff. Using the coverage class chart, estimate the percentage of mineral soil exposure onsite and in the offsite control. Make sure that the undisturbed islands are excluded from these calculations.
- 20. Litter:** This evaluation is based upon the amount of time necessary for one person to clean up the site. Keep track of the time required to rehabilitate the site and record the value in the appropriate box. Exclude litter that appears to have washed up on shore and is not related to recreational use of the site.
- 21. Fire Scars, Number:** Fire scars are defined as any fire ring, charcoal, ashes, or blackened area contained within site boundaries.
- 22. Fire Scars, Total Square Miles:** Using a measuring tape, determine the total square miles of affected area within the site boundaries.
- 23. Camp Developments:** This evaluation is also based upon the amount of time necessary for one person to clean up the site. Keep track of the time needed to rehabilitate the site and record the value in the appropriate box.
- 24. Human/Dog Waste:** Human waste is most frequently found outside site boundaries. While walking the periphery of the site and any trails

leaving the site, look for evidence of human/dog waste. Unfortunately, human waste is often accompanied by toilet paper, evidence that can assist with the location of unburied piles.

**25. Root Exposure:** Using the values provided, record the number of trees with roots exposed located within the site boundaries.

**26. Tree and Shrub Damage:** Using the values provided, record the number which best represents human caused damage to trees and shrubs located within the site.

**Materials/Gear List:**

- Topographical maps 1: 63,360 scale [no degree here]
- Aerial photos
- Silva ranger compass
- Clinometer
- Tape measure (meters)
- Flagged wire pins or Flagging (2 separate colors for site remeasurement)
- Camera—35 mm
- Film
- Tatum:
  - forms and directions on “Write-In-The-Rain” Paper
  - pencils
- Video camera
- Loggers (dbh) tape

**References**

Cole, David N. 1989. Wilderness Campsite Monitoring Methods: A Sourcebook. Research Paper INT-259. Ogden, UT: U.S. Department of Agriculture, Forest Service, Intermountain Forest and Range Experiment Station. 57p.

Marion, Jeffrey L. 1991. Developing a Natural Resource Inventory and Monitoring Program for Visitor Impacts on Recreation Sites: A Procedural Manual. Natural Resources Report NPS/NRVT/NRR-9)/06. Denver, CO: U.S. Department of the Interior, National Park Service, Cooperative Park Studies Unit. 59p.

Marion, Jeffrey L. 1996. Campsite Monitoring Manual for Gwaii Haanas National Park Reserve. Queen Charlotte City, British Columbia, Canada. 11p.



# Campsite Monitoring Form

## Inventory Parameters

1) Inventoried by:

2) Date Inventoried:

3) GPS Coordinates: Lat.

Long.

4) Map Coord: T          R          Sec.          1/4

5) Map Name:

6) Camp Name:

No.:

7) Beach Aspect:

8) VCU:

9) Island:          Kuiu:          Kupreanof:          Mitkof:          Mainland:          Other:

10) Aerial Photo: Year:          Line:          Number:

11) Site Location Description:

12) Vegetation Type:

Beach (Non-Veg):	Woodland:	Muskeg:	Beach (Veg):
Meadow/Grass Flat:	Other:		

13) Photo Point Descriptions:

Type of Camera:

Lens:

ASA:

1) _____	_____	_____
2) _____	_____	_____
3) _____	_____	_____
4) _____	_____	_____
5) _____	_____	_____

14) Exotic Plants Present:          Yes:          No:

1) _____	2) _____
3) _____	4) _____

15) Substrate of Landing Area (B = bedrock, C = cobble, S = sand, O = soil):

16) Substrate of Camping Area (B = bedrock, C = cobble, S = sand, O = soil):

17) Vegetative Ground Cover Onsite:

1 = 0-5%          2 = 6-25%          3 = 26-50%          4 = 51-75%          5 = 76-95%          6 = 96-100%

17) Vegetative Ground Cover Offsite:

1 = 0-5%          2 = 6-25%          3 = 26-50%          4 = 51-75%          5 = 76-95%          6 = 96-100%

18) Organic Duff Onsite:

1 = 0-5%          2 = 6-25%          3 = 26-50%          4 = 51-75%          5 = 76-95%          6 = 96-100%

18) Organic Duff Offsite:

1 = 0-5%          2 = 6-25%          3 = 26-50%          4 = 51-75%          5 = 76-95%          6 = 96-100%

19) Mineral Soil Exposure Onsite:

1 = 0-5%          2 = 6-25%          3 = 26-50%          4 = 51-75%          5 = 76-95%          6 = 96-100%

19) Mineral Soil Exposure Offsite:

1 = 0-5%          2 = 6-25%          3 = 26-50%          4 = 51-75%          5 = 76-95%          6 = 96-100%

# Campsite Monitoring Form

## Impact Parameters

### 20) Litter:

- 0 = None
- 1 = A few small pieces of litter and/or up to 30 seconds of cleanup time.
- 2 = up to 1.5 minutes of cleanup time.
- 3 = moderate amount of litter and/or up to 10 minutes of cleanup time.
- 4 = moderate to heavy amount of litter and/or up to 10 minutes of cleanup time.
- 5 = widespread litter, graffiti, and/or more than 10 minutes of cleanup time.

### 21 - 22) Fire Scars:

- Number (Includes fire rings)
- Total square meters

### 23) Camp Developments:

- 0 = None
- 1 = Slight evidence of linear or radial rock/log arrangements.
- 2 = Few constructions: e.g., rock/log arrangements, nails, trenching; up to 5 minutes of cleanup time.
- 3 = Some constructions: e.g., rock/log arrangements, nails in trees, trenching; up to 10 minutes of cleanup time.
- 4 = Constructions: game poles, nails in trees, rope swings, rock/log arrangements; up to 15 minutes of cleanup time.
- 5 = Well-developed constructions: benches, shelves, tables, leveled tent pads, floats, strung nets; more than 20 minutes of cleanup time.

### 24) Human/Dog Waste:

- 0 = None
- 1 = Not evident to the casual observer.
- 2 = 1 exposed pile.
- 3 = 2 exposed piles.
- 4 = 3 exposed piles.
- 5 = 4 or more exposed piles.

### 25) Root Exposure:

- 0 = None
- 1 = 1 to 2 trees with roots exposed.
- 2 = 3 to 4 trees with roots exposed.
- 3 = 5 to 6 trees with roots exposed.
- 4 = 6 to 7 trees with roots exposed.
- 5 = > 7 trees with roots exposed.

### 26) Tree and Shrub Damage:

- 0 = None
- 1 = A few small tree branches or bushes bent or flattened.
- 2 = 1 to 2 substantial tree branches cut, broken, gashed, damaged; or a carved or damaged trunk.
- 3 = 2 to 4 substantial tree branches cut, broken, damaged; or carved or damaged trunk.
- 4 = 5 to 6 substantial tree branches cut, broken, or damaged; or death of a tree or bush.
- 5 = more than 6 substantial branches or bushes broken, cut, or damaged; death of a tree or bush; any stump > 3 inches in diameter.

# Campsite Monitoring Form

## Site Map

Primary Pinpoint Location Coordinates:

Latitude:

Longitude:

### Reference Points:

	Description	Bearing	Distance (m)
1)	_____	_____	_____
2)	_____	_____	_____
3)	_____	_____	_____

### Boundary Points:

	Bearing	Distance (m)
1)	_____	_____
2)	_____	_____
3)	_____	_____
4)	_____	_____
5)	_____	_____
6)	_____	_____
7)	_____	_____
8)	_____	_____
9)	_____	_____
10)	_____	_____
11)	_____	_____
12)	_____	_____
13)	_____	_____
14)	_____	_____
15)	_____	_____

# APPENDIX G

## Restoration and Management Notes 13(2): 190-197 1995 Techniques for Plant Establishment in Arid Ecosystems

David A. Bainbridge  
Matthew Fidelibus  
Robert MacAller

*Reproduced with permission of the publisher.*

---

Recognition of the need for ecosystem restoration is growing in arid lands. Increasing use of deserts has resulted in plant and soil degradation which can be reversed by reestablishing native plants. Without intervention, desert areas disturbed by human activities such as off-road vehicle recreation and mining may take decades or centuries to recover (Bainbridge and Virginia, 1990). Conditions favorable for seed germination and seedling establishment are infrequent and unpredictable in the desert, making direct seeding an ineffective restoration strategy (Cox et al., 1982; Barbour, 1968). Fortunately, many desert shrubs are easy to grow in a nursery and respond well to transplanting. But in harsh desert climates, intense solar radiation, high temperatures, high winds, low rainfall, low soil fertility, and intense herbivore pressure can limit transplant success unless plants are prepared carefully and protected after planting. Our research in the Mojave and Sonoran Deserts of California has identified nursery production techniques and seedling protection methods that improve survival. In this article we provide an overview of successful desert revegetation practices, which should also prove useful to many workers in less severe environments. It begins with a review of containers and soil mixes for transplant preparation, followed by a discussion of strategies for protecting transplants from environmental stress.

### **Container Types and Soil Mixes**

One of the most important choices in developing a planting program on an arid site is understanding the bureaucratic, biological, and physical constraints on the restoration project and, with these in mind, choosing containers that can deliver survivors in the

field at minimum cost. This overview reflects almost ten years of experience in this area, and concludes with some general recommendations for restorationists working in arid environments.

### **Container Characteristics**

The primary function of any container is to hold the growing medium, which supplies the roots with water, air, mineral nutrients, and physical support while the seedling is in the nursery. While some container characteristics influence the growth of seedlings in the nursery, others are related to economic and management considerations at the planting site. Although little research has been conducted on the design of containers to meet the special requirements of desert seedlings, a number of practitioners suggest that these plants may benefit from deeper (taller) containers than are commonly used (Smith, 1988; Felker et al., 1988; Bainbridge, 1987, 1994a; Holden, 1992).

Seedlings destined for arid and semiarid sites differ from many ornamental plants because they are basically a root crop, while ornamentals are grown for their flowers, foliage, or shoots. Survival on arid sites, however, often depends on root growth potential and the ability of the root system to gain access to soil moisture and generate new roots.

Containers should be designed to encourage the seedling to form an extensive and vigorous root system that can be protected until the seedling is planted. Plants produced for disturbed arid sites, where growth is commonly limited by water or nutrients, should have a large, active root system

because uptake of nutrients and water is increased with greater root biomass (Barbour et al., 1987). The container characteristics described below influence root development and the root-to-shoot ratio of developing plants.

### **Container Size**

Restoration planners should select a container that will produce a healthy seedling at the highest practical growing density (in the shortest possible time) to suit the project, the environment of the site, and the project maintenance plan. Economic and administrative factors, such as the likelihood (inevitability?) of delays in delivery, acceptance date, and irrigation and maintenance scheduling should be realistically appraised. The initial cost and availability of containers, soil mixes, irrigation, handling and planting, and the available growing space are important considerations, but the final cost per survivor should be the primary concern. The size of the seed or cutting, growth rate, susceptibility to disease, temperature preferences, and desired outplanting size must all be considered.

Container height (depth) is especially important because it affects the length and biomass of the roots and the water-holding capacity, and aeration of the growth medium. The ratio of width (diameter) to height (W/H) is the aspect ratio. Aspect ratios of commercially available containers vary greatly, from more than 1 to as low as 0.1. For desert work, tall, narrow containers with aspect ratios in the range of 0.12 to 0.20 are usually preferred, both because most desert plants are deep-rooted and because slender containers are less costly to transport and outplant.

In general, larger seedlings will survive better than small ones. However, increasing size increases cost in four ways: (1) larger containers are more expensive to buy and fill; (2) they take up more growing space, (3) they require longer growing periods for the seedling root system to effectively occupy the container, and (4) they cost more to handle in the nursery, to ship, and to plant.

The optimal container will produce the smallest stock that will survive at acceptable rates in the field. Survival rates can be improved if outplanting is properly timed. We have found that some species,

such as honey mesquite (*Prosopis glandulosa* var. *torreyana*), survived best when planted in mid-spring to mid-summer (although crew members wilted at temperatures over 40 degrees C (100 degrees F)), while other species prefer early spring planting. Plant ecophysiology is a key consideration, and should be studied before developing a planting program.

### **Container Temperature**

The growth and survival of both roots and root symbionts (mycorrhizae and rhizobia) require appropriate soil temperatures. They are strongly affected by the color and insulating properties of the container materials. Dark-colored containers absorb more solar energy and become warmer than lighter ones. Brown (1982) found that changing container color from black to white reduced the temperature of the growing medium by 7 degrees C (11 degrees F) and produced more vigorous plants. Color can be especially important in desert nurseries where air temperatures may reach 43 degrees C (110 degrees F) and black containers may reach surface temperatures above 71 degrees C (160 degrees F).

### **Container Comparisons**

The best container to use depends on the season, the handling process, the species, and the project goals. Again the prime consideration should be to minimize the cost per survivor. Bigger containers may produce larger plants and higher survival rates, but they can be much more expensive to work with. Since cost and survival are major concerns in desert work, we will review the common container types used by restoration workers.

### **Supercells**

Systems with individual cells in a holding tray (Ray Leach Conetainers [sic] are desirable because they allow re-sorting of plants. This is especially important when you are working with poorly understood plant species or low-quality seeds because it facilitates removal and replacement of diseased or otherwise undesirable seedlings and empty cells. It also facilitates selection of matched cohorts of plants for experimental work and, of course, replacing empty cells saves space in the greenhouse and during storage and shipping. However, the containers that fit these trays are relatively shallow (12-21 cm).

The 10 in<sup>3</sup> cell, commonly referred to as a Supercell, is one of the most commonly used containers for desert plant production, and has been tested with many species. The hard plastic trays that hold the cells are relatively fragile and are likely to be damaged if they are handled repeatedly while loaded with seedlings. They are also heavy, with a rack of 98 plants in sand-based medium weighing almost 22.7 kg (50 lbs).

Seedlings can be removed from these containers by gently squeezing the Supercell or by rapping the top of the cell on a hard surface, using momentum to dislodge the root ball. With the sandy soil-mixes commonly used for desert-plant production the soil usually falls away from the plant as it is removed and the seedling is effectively bare-rooted. Plants with fragile roots can be removed more gently by kneading the cell under water.

An experienced planting crew of three can plant 150-225 plants per day (50-100 plants per person per day) from Supercells under typical field conditions (Bainbridge and Virginia, 1990). Much of this time is spent hauling water, watering, and installing protective devices. Estimated planting costs run from \$0.50 to \$3.00 per plant. After one year we have had nearly 90 percent survival for catclaw (*Acacia greggii*) grown in 164 ml (21 cm deep) Supercells planted on goldmine spoils in the eastern Mojave Desert (Fidelibus and Bainbridge, 1995).

### Plant Bands

Plant bands are open-ended boxes made of folded and glued plastic or foil-coated cardstock [see figure G1.] Heavy stock with foil on both sides is best, but plastic or wax-coated material is suitable for short rotations. Extreme temperatures can melt the thermoset glue on plant bands, so seams should be faced to the inside of blocks of cells to prevent delamination. Standard sizes are available, but almost any size can be custom-made for larger orders. They have proved very effective in semi-arid and arid sites in California and Texas (Bainbridge, 1994a; Felker et al., 1988).



Figure G1—Plant bands.

One of the advantages of plant bands is ease of transplanting. With larger sizes (5 cm x 5 cm) and the loose mix used for desert plants, the banded plants can be placed directly in the planting hole and the band can be pulled [up] and over the plant without disturbing the roots. When more cohesive soil mixes are used, it is often necessary to rip or cut open the band to remove the plant.

A wide range of plant-band sizes (up to 3" x 3" x 24" [7.6 x 7.6 x 70 cm]) has been tested, with generally positive results. A 12-16" (30.5-40.6 cm) tall, 2" (5.1 cm) square cell seems most useful. We have used these extensively in the Mojave and Sonoran Deserts with many species and with excellent results. Bladder-pod (*Isomeris arborea*, for example, has grown from 15 cm (6 in) at outplanting to over 70 cm (28 in) within one year. Many species have set seed during the first growing season.

Because of their large volume, plant bands allow for greater root development in greenhouse stock than do Supercells. In addition, it is easier and less time-consuming to remove plants from these containers when transplanting. They are our preferred container.

### Tall Pots

Plants have been grown in plastic pipe sections ranging from  $\frac{3}{4}$ " x 30" (1.9 x 76.2 cm) to 6" x 32" (15.2 to 81.3 cm). It has proved necessary to saw smaller diameter pipes open to remove plants, which is very labor intensive and costly. Smooth-walled PVC is desirable, as roots may be entangled in rougher textured plastic (drain pipe, for example) causing root damage during planting. Plants are commonly grown for at least a year to allow roots to fill the rooting volume. They can be maintained in the nursery for several years, if necessary. Before planting the tops are pruned and hardened off to provide a very tough plant with a high root/shoot ratio. Pruning also makes it easier to remove the container by pulling it up and over the shoot during planting, as with a plant band.

Just before planting the screen at the bottom of the container is removed and the container is placed in an augured, prewetted hole (Holden, 1992). The hole is partially back-filled and then, as back-filling continues, the container is pulled out by hand or with hay hooks inserted in two holes drilled in the top rim. The large volume of soil mix protects the roots during and after planting and provides conditions for rapid growth. Tall pot (6" x 32" [15.2 x 81.3 cm]) pipe containers, have been very successful at Joshua Tree National Monument (Holden, 1992), and creosote bush (*Larrea divaricata*), salt bush (*Atriplex canescens*), and other species planted from these containers at Red Rock Canyon and Anza Borrego Desert State Park have had very high survival rates. We have also had positive results in a few trials with a mini-tall pot (4" x 24" [10.2 x 61.0 cm]) developed at the California Department of Forestry Reforestation Center in Davis, California. Survival of bursage [*Ambrosia dumosa*] from these containers planted at Red Rock canyon [sic] was high, and the pots were easier to transport than the larger tall pots, but removal of the seedlings was a little more difficult.

We have found that the large root system has enabled creosote bush and salt-bush transplants to survive even after being gnawed to the root crown by herbivores. In addition, these containers allow rapid growth and fast recovery and are well suited for plantings intended to block trail ends or old roads. However, the size and weight of pipe sections make them costly to transport and plant [see figures G2 and Figure G3].



Figure G2.



Figure G3.

**Block Containers**

Although we have not used Styrofoam blocks with planting cells for operational planting, they appear promising for many species. These foam blocks come in a wide variety of cell capacities (16-121 ml [2.3 to 20 cubic inches]), depths up to 23 cm (9 in) and cell densities. They have become the predominant planting container for forest nurseries in many areas because they are easy to handle and provide a good growing environment. The foam is also an excellent insulator, reducing temperature extremes in the rooting zone. Roots of some species grow into the cavity walls making the seedlings difficult to extract and the blocks difficult to clean and sterilize unless copper root-retardant paint is applied to the cells (Landis, 1990). Foam blocks appear most useful for well understood plant species with non-invasive roots when high quality seeds are available.

**Plastic Pots**

Standard landscaping pots appear to work reasonably well for shallow-rooted species. Both ocotillo (*Fouquieria splendens*) and cholla (*Opuntia spp*) have been planted at highly disturbed sites in Anza Borrego Desert State Park from 1-gallon pots with adequate survival. Plants like ocotillo can be planted deeply, with much of the stem buried, to protect the root mass.

**Soil Mixes**

Desert plants are generally drought-tolerant (up to 50-60 bars), have high oxygen demands, and are susceptible to many nursery pathogens. They commonly benefit from rapid draining, porous soil mix. While greenhouse plants are commonly produced with a fertile soil mix, which results in a large, green and vigorous shoot, high nutrient levels may inhibit root growth and contribute to a low root-to-shoot ratio (R:S). Increased root biomass appears critical for seedlings, which are less water efficient than mature plants (Rundel and Nobel, 1991).

Additionally, most desert plants form or require symbiotic associations with vesicular arbuscular mycorrhizal fungi (VAM). Inoculating plants with appropriate fungi may increase survival and growth of many species. The fungal association improves phosphorus, water, and nutrient uptake (Allen, 1988; Allen, 1992). Studies have shown that transplants

which received VAM inoculations grew faster and outcompeted weedy annuals more effectively than uninoculated plants (Allen and Allen, 1984). Inoculation adds another complication to the task of providing nutrients to young plants. The fungi require nitrogen, but may be inhibited by phosphorus, so it is important to provide these nutrients in ratios that optimize growth of seedlings and mycorrhizae (Hayman, 1982; INVAM Newsletter, 1994). The VAM fungi also require well-aerated soil, in contrast to the rhizobia, which tolerate much lower oxygen levels.

**Handling**

Planting typically costs much more than production. Labor productivity and cost are highly variable depending on environmental conditions such as temperature, wind speed, soil conditions, site characteristics, and the skill of the crew. Obviously, planting rates will go down when temperatures exceed 40 degrees C (100 degrees F). The figures in Table 1 provide estimates of what to expect under ordinary conditions.

Table 1—Planting rates using various types of containers.

Container	Seedlings/person/day
Supercell	50-100
Supercell jellyroll	100-200
Plant band	100-120*
1-gallon pot	40
2-gallon pot	30
Tall pot	10

\* 50-100 if plant band must be cut off

Notice that these rates are much lower than forest planting rates, which may exceed 1,000 seedlings per person per day. Moreover, under the severe conditions of the desert, poor planting techniques and insufficient attention to detail can be dangerous. Planters should be carefully trained and projects should develop a quality control program.

Container stock grown for desert conditions is usually heavy and costly to ship and handle in the field, making outplanting difficult and expensive (Bainbridge and Virginia, 1990). One technique for making handling easier is to remove seedlings from their containers and growth media at the greenhouse



and wrap them in moist Kimtex® fabric (a technique known as jellyrolling) prior to shipping to the restoration site (Fidelibus, 1994). An ice chest holding several hundred jellyrolled plants may weight less than 98 plants in Supercells. Physiological and survival data for jellyrolled desert seedlings compares favorably with data for containerized plants (Fidelibus and Bainbridge, 1994). Not all species may be as tolerant of jellyrolling, and some species-specific differences have been noted.

### Plant Protection

All of the effort and costs associated with researching site characteristics and species physiology, selecting the best containers and soil mixes for a project, and outplanting seedlings may be wasted in a few hours or days unless adequate protection is provided for transplants. Newly transplanted seedling[s] are highly susceptible to grazing pressure, high winds, moisture stress, and extreme temperatures (Bainbridge, 1994b). Protection from these environmental pressures can often be the determining factor in transplant establishment and survival. We provide an overview and recommendations based on our experience in the Sonoran and Mojave Deserts.

### Herbivory

Herbivory is increasingly recognized as a critical factor in seedling survival in arid environments (McAuliffe, 1986; Bainbridge and Virginia, 1990). Newly planted seedlings are often the most succulent plants available, and rodents, rabbits, reptiles, domestic livestock and insects find them especially attractive. This herbivory can severely damage and even kill seedlings unless they are protected.

Blacktail jack rabbits (*Lepus californicus*), other rabbits, and rodents have been the most troublesome herbivores in our trial plantings. We have observed that seedlings of many species can survive heavy browsing if they have access to water, but if they are dry or have a limited root system browsing quickly proves fatal.

Protection from the wind can be crucial in extreme environments (Virginia and Bainbridge, 1987). In addition to sand blast effects, plants may be damaged or killed by the mechanical action of high winds (Bainbridge and MacAller, 1995). We have observed

multiple branching as a common response to wind damage on unprotected catclaw planted on mine spoils in the east Mojave Desert. In these cases, shrub height is restricted to within a few inches of the soil surface and growth can only occur laterally (Fidelibus and Bainbridge, 1994). In other cases young tree seedlings have been blown completely out of the ground.

In addition to lack of available water, the low humidity, high winds, and high temperatures of arid lands create desiccating conditions (Sorensen, 1993). Some protection strategies can reduce evapotranspiration and reduce moisture stress on seedlings. This appears to be most critical in the six to eight weeks after transplanting. Plants usually receive only a few liters of supplemental water, so water conservation is critical.

Protection may also be needed to reduce the adverse effects of extreme heat and cold. Freezing temperatures are not uncommon, and many desert plants (especially young and well hydrated transplants) are easily damaged by freezing (Bowers, 1980). Here is an even more serious problem, with soil temperatures exceeding 60 degrees C (140 degrees F) in the summer. High radiation levels exacerbate the damaging effects of high air temperatures.

### Protection Options

Many strategies have been developed to protect plants from environmental pressures. These include tree shelters, rock mulches, plant collars, and animal-repellents [sic]. All of these may be effective when properly used and matched with site conditions and herbivore species. Their advantages and disadvantages should be carefully considered, and alternatives should be tested before they are applied on a large scale.

Almost ten years of testing enables [sic] us to provide a good review of the strengths and weaknesses of some of the more commonly used techniques. These options are listed for use with seedlings of perennial shrubs on a typical exposed site with moderate to high windblast and herbivory, but recent experience indicates that the tree shelters may also be very beneficial for annual plants as well.

### Tree Shelters

Many companies have introduced tree shelters in recent years. These are commonly plastic tubes of various sizes, configurations and materials. Though there are many unanswered questions about tree shelters, many restorationists are finding that they can be very helpful (Windell, 1993; Sorensen, 1993; Bainbridge, 1994; Bainbridge and MacAller, 1995). (See the Proceedings of the June, 1995 Tree Shelter Conference in Harrisburg, Pennsylvania, [USDA Forest Service] for current information on suppliers.) (Editor's note: For information on this conference contact the Center for Urban Forestry at the Morris Arboretum, University of Pennsylvania, 9414 Meadowbrook Ave., Philadelphia, PA 19118; 215-247-5777.)

Tree shelters have worked well in the desert, but they are not appropriate for all situations and species. To use them effectively it is necessary to have some idea how they work. While this is not completely clear, some things are known: Tree shelters reduce light, decrease wind, increase the relative humidity (depending on the irrigation schedule), protect plants from herbivores, and improve water delivery.

All of these characteristics benefit outplanted seedlings by reducing plant shock and biotic and abiotic stress. However, there are also biological costs. The reduced light, although initially advantageous may, over time, be detrimental to plant health. Lowered light levels may, in some species, for example, creosote bush, decrease photosynthetic activity, reduce the growing season, and limit growth (Sorensen, 1993). Although transpiration often keeps shelter temperatures below ambient air temperature, the leaf temperature may rise far above ambient temperature when protected plants are not irrigated. How plants respond to these conditions will depend on their ability of [sic] to acclimate to, or at least tolerate, the combination of low light and high temperatures.

### Tubex® Tree Shelters

Tubex® Tree Shelters are translucent, solid-walled 7.5-cm (3-in) diameter cylinders available in a variety of heights (0.2-2 meters). We have mostly used tan-

colored (which greatly reduces solar radiation), twin walled, polypropylene Tubex shelters ranging in size from 15 to 50 cm in height. There are placed over the plant immediately after transplanting, and the bottom of the cylinder is inserted several (5-10) centimeters into the ground.

Tubex® Tree Shelters protect transplants from many environmental stresses. If transplants are tall or if they are growing rapidly, herbivores can easily graze the foliage growing out of the top. This light grazing has not had a significant adverse effect on most of our transplants (Bainbridge and MacAller, 1995). However, herbivores have been able to pull some plant species out of the ground, leaving only bare, dead, roots in empty shelters. Jack rabbits at one site also learned to kick over the tree shelters even when they were securely buried in the ground. We have also found that Tubex® dramatically reduces light intensity (Sorensen, 1993), and that they very effectively direct water to the root zone when it is poured inside the tree shelter.

The narrow diameter of the tube can have adverse effects on the architecture of shrubs developing in it. Plants left in these tree shelters too long acquire a cylindrical shape. In addition, the reduced light can increase stem elongation, creating a relatively tall, weak stem which branches out at the top of the shelter, creating a mushroom shape. This can make removal difficult unless the shelter is cut with a knife or clippers. This has been a problem especially with bursage (*Ambrosia dumosa*) and bladder-pod transplants, which are fast growing, bushy shrubs. The odd shape of the plant may also make the shrub susceptible to wind damage; however, most transplants have recovered to a "natural" shape over time. We have had high survival rates with many species, including burrobrush (*Hymenoclea salsola*) and catclaw at Red Rock Canyon and Castle Mountain Gold Mine (Bainbridge and MacAller, 1995; Fidelibus and Bainbridge, 1994). These appear to be best for upright, leader-dominant shrubs and trees.

### TreePee®

TreePee® shelters are recycled plastic, translucent-red colored, open-top conical tubes with three integral wire mounting pins. TreePees® have an 8" diameter

base (more than twice as large as the Tubex®) tapered to a 4' diameter top and are 24" in height.

These shelters function much like the Tubex® but are much taller and wider, and provide additional protection from herbivory. Although the pins make the shelters easier to anchor, it is harder to force the base of the tree shelters into the soil, so that water applied through the top of the shelter often leaks out around the base reducing delivery to the root zone.

Burrobush have had excellent survival and health when protected by TreePees® (Bainbridge and MacAller 1995). The results were similar to those we got with Tubex®, but no herbivory occurred in TreePee®. These would be a good choice for plants that are sensitive to light grazing and for lower growing, spreading plants. In addition, we have observed that armed senna (*Senna armata*), bladder-pod, and bursage have had good survival and growth (most having had flowers and set seed) after one year at our Red Rock Canyon site. However, they are more expensive than Tubex® and are more easily degraded by sunlight, and so are rarely useful for more than two seasons.

### Wire Cages

Wire cages provide protection from herbivores, but few physiological benefits, although the cage can be wrapped with bubblepack plastic in a pinch. We usually use wire cages composed of 3.8-cm wire mesh threaded and staked to the ground with pencil rod (7 mm) rebar. Cages can be made with mesh sites ranging from window screen to 6-inch concrete reinforcing mesh (depending on the size of the herbivore) and in any height and diameter desired. Although material costs are low installation and removal is [sic] labor-intensive and costly. Each cage must be cut, threaded with rebar (which also acts as a surface anchor) or fastened with aviary clips (small, flat clips used to clip wire mesh together) and staked to the ground. In addition, cages are bulky and require more space than the easily stackable Tubex® or TreePee® tree shelters.

Burrobush protected by cages at Red Rock Canyon had survival rates comparable to those protected by Tubex® or TreePees®, but were not as healthy

(Bainbridge and MacAller, 1995). No plants without protection survived in this rest. Removal can be difficult, and very costly if you wait too long and let the plant grow through the wire mesh.

### Other Available Shrub Protection

There are also many other strategies for protecting plants. Our experience with some of the lesser known techniques to protect plants include:

#### Rock Mulch

Rock mulch provides good protection from temperature extremes and some protection from herbivory. Three or more medium to large (10-20 cm diameter) rocks are arranged around each seedling. The thermal mass of the rocks provides some thermal buffering, the rocks themselves reduce evaporation from the soil, act as a wind break, and, if properly placed, discourage grazing.

If rocks are available, the cost is low and the resulting arrangements can be attractive—a consideration in some situations. As the plants grow the rock mulch can be left in place. We have considerable experience with rock mulch in the Coachella Valley, and were pleased with results in years when herbivory was moderate.

#### Plant Collars

Even fairly short collars of plastic, peat, or paper can increase survival rates. These improve watering efficiency and reduce sandblast and evapotranspiration of young seedling. They also provide some protection from grazing and reduce bending and mechanical damage. We used 4-6 inch collars made from 3- to 4-inch diameter PVC pipe before tree shelters became available. Peat collars provided some benefits at Anza-Borrego Desert State Park, but were not as effective as tree shelters. Paper protectors were also marginally effective.

#### Repellent

Repellents may provide some protection in the desert. These include both commercial and home-made solutions applied to plants to make them less palatable. We tested three commercially available repellents on bladder-pod transplants at Red Rock Canyon in 1993-1994: Anipel systemic tablets (placed

1 inch below the stem in direct contact with the root), Ropel deterrent spray, and Hinder repellent spray. We found that all three repellents slowed grazing slightly, but long-term damage was comparable to that on untreated controls, and the effects of the repellents were not statistically significant. We suspect that systemics may prove more effective when applied in the nursery at the time of sowing or inserted in the container several weeks before field planting (so the plant has time to assimilate the repellent) or on plants that are irrigated on a regular basis.

**Conclusions**

Costs are commonly under-estimated in planning and reviewing restoration projects. Full cost-accounting is crucial if the restorationist is to determine the best approach for planting on the basis of cost per survivor. Planting small plants in urban areas may cost more than \$15 per survivor if administration and maintenance costs are included, and costs in the desert can be even higher unless plants are well prepared, properly and efficiently planted, and protected from herbivory and environmental stress. Estimates of these costs for small projects on remote sites are shown in Table 2. Experienced planting crews and economies of scale may cut costs in half on larger projects.

Table 2—Estimated cost (in dollars) of individual nursery stock and stock that survived planting using various containers.

Container	Individual Nursery Stock	Field Survivor
Supercell	0.10-0.15	15.00
Supercell jellyroll	0.10-1.75	15.00
Plant band	1.00-4.00	10.00
1-gallon pot	3.00-5.00	20.00
2 gallon pot	5.00-10.00	25.00
Tall pot	9.00-25.00	30.00

**Recommendations**

Obviously no one container or production system is suitable for all conditions and species. To maximize survival while minimizing cost, it is often best to use a combination of container types and sizes (even for plants of the same species on the same site). This not only allows the restorationist to make a calculated gamble (hedging bets between installation costs and survival) but also results in a more diverse community architecture consisting of multiple size- and age-classes of plants. It also provides a hedge against unusually severe conditions, which may wipe out all but a few of the strongest plants.

Our experience has demonstrated the value of a robust root system, and this is why we feel that plant bands are an excellent choice for difficult sites. They encourage good root development, are relatively easy to transport and can be planted with minimal effort and root disturbance. In addition Tall pots and the new Minitall pots deserve much wider recognition and use as an enrichment planting tool. The fast growth under severe conditions of plants grown in these pots is impressive.

We have found that the best way to increase the numbers of outplant survivors is to provide them with some form of protection from damaging influences. Although there are still questions about how enclosed tree shelters affect the micro-environment and physiology of many species, it is clear that their use can increase field survival rates dramatically.

The key to success is understanding the plant and the site, working hard to develop a robust root system, and protecting the shoot against excessive grazing and environmental stress. Doing this can yield good survival rates, fast recovery, and minimal cost per acre.

## References

- Allen, E. B. and M. F. Allen. 1984. Competition between plants of different successional stages: mycorrhizae as regulators. *Canadian Journal of Botany* 62: 2625-2629.
- Allen, M. F. 1988. Below ground structure a key to reconstructing a practice and ecosystem. Pp. 113-135 in E. B. Allen (ed.) *The Reconstruction of Disturbed Lands: An Ecological Approach*. Westview Press. Boulder, Colorado.
- Allen, M. F. 1992. *Mycorrhizal Functioning*. Chapman and Hall, NY.
- Bainbridge, D. A. 1994 a. Container optimization-field data supports container innovation. in *Proceedings Western Forest and Conservation Nursery Association Meeting*. U.S. Department of Agriculture, Forest Service, Rocky Mountain Forest and Range Experiment Station, Ft. Collins, (in press).
- Bainbridge, D. A. 1994 b. Treeshelters improve establishment on dry sites. *Tree Planters Notes* 45(1):13-16.
- Bainbridge, D. A. and R. A. Virginia. 1990. Restoration in the Sonoran Desert. *Restoration and Management Notes* 8(1):3-14.
- Bainbridge, D. A. and R. T. MacAller. 1995. Treeshelters improve desert planting success. in *Proceedings of the 1995 Treeshelter Conference*. USFS PA. (In press).
- Barbour, M. G. 1968. Germination requirements for the desert shrub *Larrea divaricata*. *Ecology* 50:679-685.
- Barbour, M. G., J. H. Burk, and W. D. Pitts. 1987. *Terrestrial Ecology*. Benjamin/Cummins, Menlo Park, CA.
- Bowen, J. E. 1980. Catastrophic freezes in the Sonoran Desert. *Desert Plants* 2(4):232- 236.
- Brown, W. L. 1982. Temperature in container affects growth of ornamentals. *Louisiana Agriculture* 26(1):8-9.
- Cox, J. R., H. L. Morton, T. N. Johnson, G. L. Jordan, S. C. Martin & L. C. Fierro. 1982. Vegetation restoration in the Chihuahuan and Sonoran Deserts of North America. *Agricultural Reviews and Manuals #28*. USDA Agricultural Research Service, Tucson, Arizona 37 pp.
- Felker, P., Wiesman, and D. Smith. 1988. Comparison of seedling containers on growth and survival of *Prosopis alba* and *Leucaena leucocephala* in semi-arid conditions. *Forest Ecology and Management* 24:177-182.
- Fidelibus, M. F. 1994. Jellyrolls reduce outplanting costs in arid land restoration. *Restoration and Management Notes* 12(1):87.
- Fidelibus, M. F. and D. A. Bainbridge 1994. The effects of containerless transport on desert shrubs. *Tree Planters Notes* 45(3):82-85.
- Hayman, D. S. 1982. Influence of soils and fertility on activity and survival of vesicular-arbuscular mycorrhizal fungi. *Am. Phytopathol. Soc.* 72(8):1119-1125.
- Holden, M. 1992. The greening of a desert. *American Nurseryman* 4 (15):22-29.

INVAM Newsletter. 1994. Culture methods and inoculum production: a reality check. *West Virginia University and the National Science Foundation* 4(2):4-6.

Landis, T. 1990. *The Container Tree Nursery Manual*. USDA Handbook 674 Forest Service, 5 vols.

McAuliffe, J. R. 1986. Herbivore-limited establishment of a Sonoran Desert tree, *Cercidium microphyllum*. *Ecology* 67(1):276-280.

Rundel, P. W. and P. S. Nobel. 1991. Structure and function in desert root systems. In: D. Atkinson (ed.) *Plant Root Growth: an Ecological Perspective*. Blackwell Scientific, Boston, MA.

Smith, J. R. S. 1988[1953]. *Tree Crops*. Island Press, Covelo, CA.

Sorensen, N. 1993. Physiological ecology of the desert shrub *Larrea divaricata*: implications for arid land revegetation M.S. Thesis. San Diego State University, San Diego, CA.

Virginia, R.A. and D.A. Bainbridge. 1987. Revegetation in the Colorado Desert: lessons from the study of natural systems. Pp. 52-62 *In Proceedings of the 2nd Native Plant Revegetation Symposium*. Society for Ecological Restoration and Management, Madison, WI.

Windell, K. 1993. Tree shelters for seedling survival and growth. *USDA Forest Service Technical Tips 2400*. 4 pp.

David A. Bainbridge is a restoration ecologist and teacher in the Biology Department, San Diego State University [SDSU], San Diego, CA 92132, 619-594-4462)[new numbers 858- 635-4616, Fax 858-635-4730.] Matthew Fidelibus 619-594-594-2641 and Roger MacAller 619-594-2641) e-mail: [macalle@sunstroke.sdsu.edu](mailto:macalle@sunstroke.sdsu.edu)) are graduate students in biology at SDSU. All three are members of the Soil Ecology and Restoration Group. MacAller maintains the group's World Wide Web site at URL <http://rohan.sdsu.edu/dept/derg/serg.html>. [New site: <http://www.sci.sdsu.edu/SERG/index.html>.]







# Appendix H

## Additional Information

This section lists several publications and Internet sites available for additional information.

### U.S. Department of Agriculture Forest Service

#### Hard Copy Publications

Kovalchik, Bernard L.; Hopkins, William E.; Brunsfeld, Steven J. 1988. Major indicator shrubs and herbs in riparian zones on national forests of central Oregon. R6-ECOL-TP-005-88. Portland, OR: U.S. Department of Agriculture, Forest Service, Pacific Northwest Region. Copies are available from the Silviculture Laboratory, 1027 NW. Trenton Ave., Bend, OR 97701. Telephone: 503-388-7434.

Regional Ecosystem Office. 1995. Ecosystem analysis at the ecosystem level: Federal guide for watershed analysis. ver. 2.2. Portland, OR: U.S. Department of Agriculture, Forest Service, Regional Interagency Executive Committee. It is available from the Regional Ecosystem Office, P.O. Box 3623, Portland, OR 97208-3623.

Regional Ecosystem Office. February 1997. Riparian reserve evaluation techniques and synthesis: supplement to section II of ecosystem analysis at the watershed scale: Federal guide for watershed analysis. Ver. 2.2. Portland, OR: U.S. Department of Agriculture, Forest Service. It pertains to western Washington, Oregon, and a small piece of northern California and is available from the Regional Ecosystem Office, P.O. Box 3623, Portland, OR 97208-3623.

Winward, Alma H. 2000. Monitoring the vegetation resources in riparian areas. General technical report RMRS-GTR-47. Ogden, UT. U.S. Department of Agriculture, Rocky Mountain Research Station. Telephone: 970-498-1392, fax 970-498-1396. E-mail at [rschneider@fs.fed.us](mailto:rschneider@fs.fed.us)

#### On-line Publications

Eubanks, C. Ellen; Meadows, Dexter. 2003. A Soil Bioengineering Guide for Streambank and Lakeshore Stabilization. U.S. Department of Agriculture, Forest Service, October 2002, FS-683. <http://www.fs.fed.us/publications/soil-bio-guide/>

U.S. Department of Agriculture. Federal Stream Restoration Working Group. 1998. Stream corridor restoration, principles, processes, and practices. Washington, DC: U.S. Department of Agriculture. Available at [http://www.usda.gov/stream\\_restoration/](http://www.usda.gov/stream_restoration/)

U.S. Department of Agriculture, Forest Service. 1997. Water/road interaction technology series. Available at <http://fsweb.sdtc.wo.fs.fed.gov>

#### Internet Sites

The Rocky Mountain Research Station, Stream System Technology Center—<http://www.stream.fs.fed.us/>  
The staff is a good resource and publishes a hydrology newsletter called “Stream Notes.” Telephone: 970-295-5984.

Northeastern Research Station—<http://www.fs.fed.us/ne/home/publications>

Pacific Southwest Research Station—<http://www.fs.fed.us/psw/topics/recreation>

Missoula Technology and Development Center, Recreation—<http://fsweb.mtdc.wo.fs.fed.gov>

San Dimas Technology and Development Center, Recreation—<http://fsweb.sdtc.wo.fs.fed.gov>

## Natural Resources Conservation Service

### Aberdeen Plant Materials Center, Idaho

<http://plant-materials.nrcs.usda.gov/idpmc/riparian.html>

This site will take the viewer to the Aberdeen Plant Materials Center to discover its research emphasis, publications, available cultivars, and other information on its programs. Most information is specific to the Great Basin. Publications include:

- Riparian and wetland tools for the Great Basin and Intermountain West Region. A collection of publications.
- The Practical Guide to Streambank Bioengineering (universal applications)
- Riparian/Wetland Project Information Series and Notes (universal applications)

The Riparian/Wetland Project has produced a number of short technical papers on riparian and wetland issues. These are written in a reader-friendly style on a wide variety of issues related to riparian and wetland plants and techniques for planting, plant community establishment, maintenance, and propagation.

### On-line publications

U.S. Department of Agriculture, Natural Resources Conservation Service. 2001. Stream corridor inventory and assessment techniques—a guide to site, project, and landscape approaches suitable for local conservation programs. Lists and rates various tools. Available at <http://www.wsi.nrcs.usda.gov/products>

## U.S. Department of the Interior Bureau of Land Management National Business Center publications

The following publications are available from the U.S. Department of the Interior (USDI) Bureau of Land Management (BLM) National Business Center. Order by telephone at 303-236-1975 or by fax at 303-236-0875.

Clemmer, Pat. 2001. Riparian area management, using aerial photographs to manage riparian-wetland areas. TR-1737-10. Denver, CO: U.S. Department of the Interior, Bureau of Land Management.

Elzinga, Caryl L.; Salzer, Daniel W.; Willoughby, John W. 1998. Measuring and monitoring plant populations. Technical reference 1730-1. Denver, CO: U.S. Department of the Interior, Bureau of Land Management, National Applied Resource Sciences Center. This publication describes a step-by-step process for monitoring a single plant species.

Pellant, Mike; Shaver, Patrick; Pyke, David A.; Herrick, Jeffery E. 2000. Technical reference 1734-6. Interpreting indicators of rangeland health. Version 3. U.S. Department of the Interior, Bureau of Land Management, National Science Center, Information and Communications Group. Denver, CO. Subject terms: rangeland health, rangeland health attributes, soil/site stability, hydrologic function, biotic integrity, ecological site description, and ecological reference area. <http://www.ftw.nrcs.usda.gov/glti>

Prichard, Don. 1996. Riparian area management, using aerial photographs to assess proper functioning conditions of riparian-wetland areas. TR-1737-12. Denver, CO: U.S. Department of the Interior, Bureau of Land Management.

Prichard, Don. 1998. Riparian area management: a user guide to assessing proper functioning condition and the supporting science for lotic areas. TR 1737-15. Denver, CO: U.S. Department of the Interior, Bureau of Land Management.

Prichard, Don. 1999. Riparian area management: a user guide to assessing proper functioning condition and the supporting science for lentic areas. TR-1735-16. Washington, DC: U.S. Department of the Interior, Bureau of Land Management.

### **On-line or other publications**

U.S. Department of the Interior, Bureau of Land Management, Partners in Flight, Boise, ID. No date. BLM/ID/PT-98/004 + 6635. Birds as indicators of riparian vegetation condition in the western United States. Jamestown, ND: Bureau of Land Management, Northern Prairie Wildlife Research Center. Available at <http://www.id.blm.gov/publications/data/indicators.pdf> (version 15 Dec 98)

### **U.S. Environmental Protection Agency**

U.S. Environmental Protection Agency, Office of Wetlands, Oceans, and Watersheds. Locate information about restoration, monitoring, American heritage rivers, and funding at <http://www.epa.gov/OWOW>

U.S. Environmental Protection Agency. 1998. Clean water action plan: restoring and protecting America's waters. EPA-840-R-98-001. This multiple-agency publication is available through the EPA's clearinghouse, the National Center for Environmental Publications and Information. Telephone: 800-490-9198.

### **Others**

#### **Internet sites**

American Water Resources Association—<http://www.awra.org>. Publications and conferences addressing water issues.

Society for Ecological Restoration. Search for restoration expertise directory. <http://www.ser.org/>

The Aldo Leopold Wilderness Research Institute—<http://www.leopold.wilderness.net/>  
Publishes a list of research papers.

### **Publications**

Bates, A. Leon; Harper, Sidney S.; Kelley, Kenneth R., Webb, David H. 1997. Banks and buffers; a guide to selecting native plants for streambanks and shorelines. Chattanooga, Tennessee Valley Authority, Clean Water Initiative, Environmental Research Center. This compact disk divides the South into watersheds, gives a selection of native plants based on criteria the user enters, and has photographs of the plants. The cost is \$25 plus \$5 delivery fee. To order, call 423-751-7338.

Berwyn, Bob. 2001. Winter's tale: wildlife disturbed by backcountry skiing. Environmental News Network. March 9. Available at <http://www.enn.com>.

Clewell, Andre; Rieger, John; Munro, Hohn. Guidelines for developing and managing ecological restoration projects. Society for Ecological Restoration. Available at <http://www.ser.org/downloads>. Click on Guidelines.pdf.

Henderson, Carol L., Dindorf, Carolyn J., Rozumalski, Fred J. 1999. Landscaping for wildlife and water quality. Saint Paul, MN: State of Minnesota, Department of Natural Resources, Non-game Wildlife Program, Section of Wildlife. To order call 800-657-3757.

Johnson, A.W.; Stypula, J.M. 1993. Guidelines for bank stabilization projects in the riverine environment of King County, WA. An update is expected in 2003. <http://dnr.metrokc.gov/wlr/biostbl> (This address sometimes fails. Keep trying or try a search engine and enter the title.) Another good site from the State of Washington is <http://directory.metrokc.gov/ProductDetail.asp?ProductID=25>

Kashanski, Catherine. 1994. Native vegetation for lakeshores, streamsides, and wetland buffers. Waterbury, VT: State of Vermont, Agency of Natural Resources, Department of Environmental Conservation Division of Water Quality. To order call 802-241-3770.

National Outdoor Leadership School. 1996. Leave no trace, outdoor skills and ethics, western river corridors. LNT Skills & Ethics Series. Vol. 4.2. NOLS. Available at <http://www.lnt.org> or call 800-332-4100 for more information. The USDA Forest Service has a partnership agreement with this organization.

Society for Ecological Restoration. 1994. Project policies. *Restoration Ecology*. 2(2): 132-133. Available at <http://www.ser.org/>

Soil and Water Conservation Society. 2000. Soil biology primer. Soil and Water Conservation Society, in cooperation with the U.S. Department of Agriculture, Natural Resources Conservation Service. Available at <http://www.swcs.org> or by telephone at 515-289-2331.

Tjaden, Robert J.; Weber, Glenda M. No date. Riparian forest buffer design, establishment, and maintenance. Fact sheet 725. College Park, MD: University of Maryland, Eastern Shore, Maryland Cooperative Extension. Available at <http://www.agnr.umd.edu/MCE/Publications/Publication.cfm?ID=13>.

## Literature Cited

- Alexander, David E.; Fairbridge, Rhodes W., eds. 1999. Encyclopedia of environmental science. Dordrecht, The Netherlands: Kluwer Academic (sold and distributed in North America by Kluwer Academic, Hingham, MA): 506-508.
- Baker, Jr., Malchus B.; DeBano, Leonard F.; Ffolliott, Peter F.; Gottfried Gerald J. 1998. Riparian-watershed linkages in the southwest. Tucson, AZ: In: Rangeland Management and Water Resources, Proceedings of the American Water Resources Association. 347-357.
- Barbour, Michael T.; Gerritsen, Jeroen; Snyder, Blaine D.; Stribling, James B. 1999. Rapid bioassessment protocols for use in streams and wadable rivers: periphyton, benthic macroinvertebrates and fish. 2<sup>nd</sup> edition. Washington, DC: U.S. Environmental Protection Agency, Office of Water; EPA 841-B-99-002.
- Bates, A. Leon; Harper, Sidney S.; Kelley, Kenneth R., Webb, David H. 1997. Banks and buffers, a guide to selecting native plants for streambanks and shorelines. Chattanooga, Tennessee Valley Authority, Clean Water Initiative, Environmental Research Center.
- Bentrup, Gary; Hoag, J. Chris. 1998. The practical streambank bioengineering guide, a user's guide for natural streambank stabilization techniques in the arid and semi-arid Great Basin and intermountain west. Aberdeen, ID: U.S. Department of Agriculture, Natural Resources Conservation Service, Interagency Riparian/Wetland Plant Development Project.
- Berwyn, Bob. 2001. Winter's tale: wildlife disturbed by backcountry skiing. Environmental News Network. March 9.
- Beschta, Robert L.; Kauffman, J. Boone. 2000. Restoration of riparian systems—taking a broader view. In: Wigington, Jr., P.J.; Beschta, R.L., eds. AWRA international conference on riparian ecology and management in multi-use watersheds. Portland, OR: American Water Resources Association: 323-328.
- Bonham, Charles D. 1989. Measurements for terrestrial vegetation. New York: John Wiley.
- Bradley, Joan. 1971. Bush regeneration: the practical way to eliminate exotic plants from natural reserves. The Mosman Parklands and Ashton Park Association, Mosman (Sydney), New South Wales.
- Brenzel, Kathleen N., ed. 1995. Sunset Western Garden Book. Menlo Park, CA: Sunset.
- Chambers, J.C. 2000. Great basin ecosystem management project: Restoring and maintaining riparian ecosystem integrity. In: Smith, H.Y., ed. Proceedings: The Bitterroot ecosystem management project—what we have learned, May 18-20, Missoula, MT: U.S. Department of Agriculture, Forest Service, Rocky Mountain Research Station.
- Chambers, Jeanne. 1999. [Personal communication]. August 23. U.S. Department of Agriculture, Forest Service, Rocky Mountain Research Station.
- Clayton. 1997. An assessment of ecosystem components in the interior Columbia Basin and portions of the Klamath and Great Basin, Vol. III. Gen. Tech. Rep. PNW-GTR-405. Portland, OR: U.S. Department of Agriculture, Forest Service, Pacific Northwest Research Station; U.S. Department of the Interior, Bureau of Land Management.

- Clemmer, Pat. 2001. Riparian area management, using aerial photographs to manage riparian-wetland areas. TR-1737-10. Denver, CO: U.S. Department of the Interior, Bureau of Land Management, National Business Center
- Cole, David. 2000. Dispersed recreation. Gen. Tech. Rep. SRS-39. Asheville, NC: U.S. Department of Agriculture, Forest Service, Southern Research Station. 81-84.
- Cole, David N. 1997. Visitors, conditions, and management options for high-use destination areas in wilderness. Missoula, MT: U.S. Department of Agriculture, Forest Service, Rocky Mountain Research Station, Aldo Leopold Wilderness Research Institute.
- Cole, David N. 1989a. Area of vegetation loss: a new index to campsite impact. Research Note INT-389. Ogden, UT: U.S. Department of Agriculture, Forest Service, Intermountain Region.
- Cole, David N. 1989b. Recreation ecology: what we know, what geographers can contribute. *Professional Geographer*. 41(2): 143-148.
- Cole, David N. 2000a. Managing campsite impacts on wild rivers: are there lessons for wilderness managers? *International Journal of Wilderness*. 6(3): 12-16.
- Cole, David N. 2000b. [Personal communication]. April 27. Missoula, MT: U.S. Department of Agriculture, Forest Service, Rocky Mountain Research Station, Aldo Leopold Wilderness Research Institute.
- Cole, David N.; Marion, Jeffery L. 1988. Recreation impacts in some riparian forests of the eastern United States. *Environmental Management*. 12(1): 99-107.
- Cole, David N.; Peterson, Margaret E.; Lucas, Robert C. 1987. Managing wilderness recreation use: common problems and potential solutions. Gen. Tech. Rep. INT-230. Ogden, UT: U.S. Department of Agriculture, Forest Service, Intermountain Research Station.
- Cole, David N.; Spildie, David R. 2000. Soil amendments and planting techniques: campsite restoration in the Eagle Cap Wilderness, Oregon. In: Cole, David N.; McCool, Stephen F.; Borrie, William T.; O'Loughlin, Jennifer, comps. *Wilderness science in a time of change conference Vol. 5: wilderness ecosystems, threats, and management*; 1999 May 23-27; Missoula, MT. Proc. RMRS-P-15-VOL-5. Ogden, UT: U.S. Department of Agriculture, Forest Service, Rocky Mountain Research Station: 181-187.
- Collins, T.M. 1992. Integrated riparian evaluation guide. Ogden, UT: U.S. Department of Agriculture, Forest Service, Intermountain Region.
- Crowe, Elizabeth A.; Clausnitzer, Roderick R. 1997. Mid-montane wetland plant associations of the Malheur. TP-R6-NR-ECOL-TP-22-97. Portland, OR: U.S. Department of Agriculture, Forest Service, Pacific Northwest Region, Umatilla and Wallowa-Whitman National Forests;
- Cunningham-Summerfield, Ben. 2000. [E-mail communication]. May 9 and 11. U.S. Department of the Interior, National Park Service, Yosemite National Park.
- Davidson, Bill. 1999. [Personal communication]. August 12. Washington, DC: The Nature Conservancy.

DeGraaf, Richard M.; Yamasaki, Mariko; Leak, William B.; Lanier, John W. 1992. New England wildlife: management of forested habitats. Gen. Tech. Rep. NE-144. Radnor, PA: U.S. Department of Agriculture, Forest Service, Northeastern Forest Experiment Station.

Diaz, N.M.; Mellen, T.K. 1996. Riparian ecological types, Gifford Pinchot and Mt. Hood National Forests, Columbia River Gorge National Scenic Area. R6-NR-TP-10-96. Portland, OR: U.S. Department of Agriculture, Forest Service, Pacific Northwest Region.

Dolloff, C. Andrew. 1994. Large woody debris: the common denominator for integrated environmental management of forest streams. In: *Implementing integrated environmental management*. Cairns, J., Jr.; Crawford, T.V.; Salwasser, H., eds. Blacksburg, VA: Virginia Polytechnic Institute and State University, Center for Environmental and Hazardous Materials Studies. 93-108.

Duffy, George. 2001. [Personal communication]. August 16. Glendora, CA: U.S. Department of Agriculture, Forest Service, Angeles National Forest.

Dunmore, Ralph. 2000. Disturbance and restoration in northern piedmont forests. *Ecological Restoration*. 18(3): 150-165.

Edwards, Fred S.; Bainbridge, David A.; Allen, Michael F. 2000. Rainfall catchments improve survival of container transplants at Mojave Desert sites. *Ecological Restoration* 18 (Summer): 2.

Egan, Dave; Howell, Evelyn A., eds. 2001. *The historical ecology handbook: a restorationist's guide to reference ecosystems*. Washington, DC: Island Press.

Elzinga, Caryl L.; Salzer, Daniel W.; Willoughby, John W. 1998. *Measuring and monitoring plant populations*. TR 1730-1. Denver, CO: U.S. Department of the Interior, Bureau of Land Management, National Applied Resource Sciences Center.

Falk, Mima. 2000. [Personal communication]. March 3. Tucson, AZ: U.S. Department of the Interior, Fish and Wildlife Service.

Fazio, James R., ed. No date. *Tree city USA bulletin for the friends of tree city USA*. Nebraska City, NE: National Arbor Day Foundation. 19:3.

Ferren, Wayne R., and St. John, Ted. 2000. *Trends and lessons in ecological restoration*. Santa Barbara, CA: The seventh annual conference of the California Society for Ecological Restoration.

Fisher, S.G.; Likens, G.E. 1973. Energy flow in Bear Brook, New Hampshire: an integrated approach to stream ecosystem metabolism. *Ecological Monographs*. 43: 421-439.

Flosi, G.; Reynolds, F. L. 1994. *California salmonid stream habitat restoration manual*. 2d ed. Sacramento, CA: State of California Resources Agency, Department of Fish and Game.

Fowler, Pat. 2000. [Personal communication]. February 14. Cadillac, MI: U.S. Department of Agriculture, Forest Service, Huron Manistee National Forest.

- Frandsen, J. 1995. Restoring Strawberry: the pure valley report on five years of mitigation and enhancement in the Strawberry Valley. Salt Lake City: U.S. Department of Agriculture, Forest Service, Uinta and Wasatch-Cache National Forest, Heber Ranger District.
- Fritzke, Sue. 2001. [Personal communication]. March 3; June 27. U.S. Department of the Interior, National Park Service, Yosemite National Park.
- Gibbons, Dave R.; Meehan, William R.; Bryant, Mason D.; Murphy, Michael L.; Elliot, Steven T. 1990. Fish in the forest, large woody debris in streams, a new management approach to fish habitat. R10-MB-86. Washington, DC: U.S. Department of Agriculture, Forest Service, Alaska Region; National Marine Fisheries Service, Alaska Department of Fish and Game.
- Gregory, Stanley V.; Swanson, Frederick J.; McKee, W. Arthur; Cummins, Kenneth W. 1991. An ecosystem perspective of riparian zones, focus on links between land and water. *BioScience*. 41(8): 540-551.
- Griggs, Tom; Stanley, John. 2000. Restoring riparian habitats. Trends and lessons in ecological restoration class. Santa Barbara, CA: The seventh annual conference of the California Society for Ecological Restoration. 7-24, 7-36, 8-8.
- Gutzwiller, Kevin J.; Anderson, Stanley H. 1999. Spatial extent of human-intrusion effects on subalpine bird distributions. *The Cooper Ornithological Society: The Condor*; 101: 378-389.
- Henderson, Carol L., Dindorf, Carolyn J., Rozumalski, Fred J. 1999. Landscaping for wildlife and water quality. Saint Paul, MN: State of Minnesota, Department of Natural Resources, Non-game Wildlife Program--Section of Wildlife.
- Hindley, Earl. 1996. Riparian area management, observing physical and biological change through historical photographs. TR-1737-13. Denver, CO: U.S. Department of the Interior, Bureau of Land Management, National Business Center.
- Hoag, J. Chris. 1995. Design criteria for revegetation in riparian zones of the intermountain area. Aberdeen, ID: U.S. Department of Agriculture, Natural Resources Conservation Service, Aberdeen Plant Materials Center; Riparian/Wetland Project Information Series No. 9.
- Hoag, J.C. 1997. Planning a project. Aberdeen, ID: U.S. Department of Agriculture, Natural Resources Conservation Service, Aberdeen Plant Materials Center; Riparian/Wetland Project Information Series No. 2. (ID# 1194). 13p.
- Hoag, J. Chris; Sellers, Mike. 1995. View from a wetland: news and technology for riparian and wetland management. Aberdeen, ID: U.S. Department of Agriculture, Natural Resources Conservation Service, Aberdeen Plant Materials Center; No. 2.
- Hoag, J. Chris; Simmonson, Boyd; Cornforth, Brent; St. John, Loren. 2001. Waterjet stinger: a tool to plant dormant unrooted cuttings of willows, cottonwoods, dogwoods, and other species. Aberdeen, ID: U.S. Department of Agriculture, Natural Resources Conservation Service, Aberdeen Plant Materials Center; Riparian/Wetland Project Information Series No. 17.
- Johnson, A.W.; Stypula, J.M., eds. 1993. Guidelines for bank stabilization projects in the riverine environments of



King County. Seattle, WA: King County Department of Public Works, Surface Water Management Division.

Johnson, Louise. 2000. [E-mail communication]. April 25. Mineral, CA: U.S. Department of the Interior, National Park Service, Lassen National Park.

Kashanski, Catherine. 1994. Native vegetation for lakeshores, streamsides, and wetland buffers. Waterbury, VT: State of Vermont, Agency of Natural Resources, Department of Environmental Conservation Division of Water Quality.

Kovalchik, Bernard L. 1987. Riparian zone associations, Deschutes, Ochoco, Fremont, and Winema National Forests. R6-ECOL-TP-279-87. Portland, OR: U.S. Department of Agriculture, Forest Service, Pacific Northwest Region.

Kovalchik, Bernard L.; Hopkins, William E.; Brunsfeld, Steven J. 1988. Major indicator shrubs and herbs in riparian zones on national forests of central Oregon. R6-ECOL-TP-005-88. Portland, OR: U.S. Department of Agriculture, Forest Service, Pacific Northwest Region.

Knight, Richard L.; Gutzwiller, Kevin J., eds. 1995. Wildlife and recreationists: coexistence through management and research. Washington, DC: Island Press.

Koski, K.V. 1992. Restoring stream habitats affected by logging activities. In: Restoring the nation's marine environment. Thayer, G.W., ed. College Park, MD: A Maryland Sea Grant Book. Washington, DC: U.S. Department of Commerce, National Oceanic and Atmospheric Administration: Chapter 8.

LaFayette, R.A.; Bernard, J.; Brady, D. 1998. Riparian restoration: treatments, options, and cautions. In Verry, Elon S.; Hornbeck, James W.; Dolloff, C. Andrew, eds. Riparian management in forests of the Continental Eastern United States. Salem, MA: CRC Press; 18:303-314.

Lardner, Melody. 1999. [Personal communication]. August 8. U.S. Department of Agriculture, Forest Service, San Bernardino National Forest.

Laurie, Michael. 1975. An introduction to landscape architecture. New York: American Elsevier.

Lucas, Robert C. 1986. Managing future forests for wilderness and recreation. RWU 4901 Pub No.175. 1986 Yearbook of Agriculture. U.S. Department of Agriculture. 217-220.

Madej, M A.; Weaver, W.; Hagans, D. 1991 Analysis of bank erosion on the Merced River, Yosemite Valley, Yosemite National Park. Arcata, CA: U.S. Department of the Interior, National Park Service, Redwood National Park

Manci, Karen M. 1989. Riparian ecosystem creation and restoration: a literature summary, baseline, costs, function, monitor, planning, and plant. Jamestown, ND: U.S. Department of the Interior, Fish and Wildlife Service, Northern Prairie Wildlife; Biological Report 89(20): 1-59.

Manning, Robert E. 1979. Impacts of recreation on riparian soils and vegetation. Water Resources Bulletin. Minneapolis, MN: American Water Resources Association; 15(1): 34 (fig. 2).

- McKee, Arthur; Gregory, Stan; Ashkenas, Linda; in conjunction with the Chippewa and Superior National Forests. 1996. Draft. Riparian management reference. MN: U.S. Department of Agriculture, Forest Service, National Forests of Minnesota.
- Ministry of Natural Resources. 1994. Natural channel systems: an approach to management and design. Ontario, Canada: Queen's Printer for Ontario.
- Mount, Jeffery F. 1995. California rivers and streams: the conflict between fluvial process and land use. Berkeley and Los Angeles: University of California Press.
- Mueller, Howard. 2000. [Personal communication]. June 28. Escondido, CA: U.S. Department of Agriculture, Natural Resources Conservation Service.
- Murphy, Michael L. 1995. Forestry impacts on freshwater habitat of anadromous salmonids in the Pacific Northwest and Alaska: requirements for protection and restoration. Silver Spring, MD: U.S. Department of Commerce, National Oceanic and Atmospheric Administration, Coastal Ocean Office; GD No. C55.49/3.7. 131-156.
- Myers, Lewis H. 1989. Riparian area management, inventory and monitoring of riparian areas. TR1737-3. MT: U.S. Department of the Interior, Bureau of Land Management, Dillon Resource Area.
- National Outdoor Leadership School. 1996. Leave no trace, outdoor skills and ethics, western river corridors. LNT Skills & Ethics Series. Vol. 4.2. NOLS.
- O'Laughlin, Jay; Belt, George H. 1993. Functional approaches to riparian buffer strip design. *Journal of Forestry*: 93: 29-32.
- Overton, C. Kerry; Wollrab, Sherry P.; Roberts, Bruce C.; Radko, Michael A. 1997. R1/R4 (Northern/Intermountain Regions) fish and fish habitat standard inventory procedures handbook. Gen. Tech. Rep. INT-GTR-346. Ogden, UT: U.S. Department of Agriculture, Forest Service, Intermountain Research Station.
- Palik, Brian; Zasada, John C.; Hedman, Craig W. 2000. Ecological considerations for the practice of riparian silviculture. In: Verry, Elon S.; Hornbeck, James W.; Dolloff, C. Andrew, eds. *Riparian management in forests of the continental eastern United States*. Boca Raton, FL: Lewis Publishers: Chapter 14.
- Parker, Tom. 1999. [E-mail communication]. September 8. Corvallis, MT: Bitterroot Restoration.
- Pellant, Mike; Shaver, Patrick; Pyke, David A.; Herrick, Jeffery E. 2000. Interpreting indicators of rangeland health – ver. 3. TR 1734-6. Denver, CO: U.S. Department of the Interior, Bureau of Land Management, National Science Center, Information and Communications Group.
- Prichard, Don. 1996. Riparian area management: using aerial photographs to assess proper functioning conditions of riparian-wetland areas. TR-1737-12. Denver, CO: U.S. Department of the Interior, Bureau of Land Management, National Business Center.
- Prichard, Don. 1998. Riparian area management: a user guide to assessing proper functioning condition and the supporting science for lotic areas. TR 1737-15. Denver, CO: U.S. Department of the Interior, Bureau of Land Management, National Business Center.

Prichard, Don. 1999. Riparian area management: a user guide to assessing proper functioning condition and the supporting science for lentic areas. TR-1735-16.

Washington, DC: U.S. Department of the Interior, Bureau of Land Management, National Business Center.

Prichard, Don. 2000. [Personal communication]. April 3. Denver, CO: U.S. Department of the Interior, Bureau of Land Management, National Business Center.

Ralph, C. John; Geupel, Geoffrey R.; Pyle, Peter; Martin, Thomas E.; DeSante, David F. 1993. Handbook of field methods for monitoring land birds. Gen. Tech. Rep. PSW-GTR-144. Albany, CA: U.S. Department of Agriculture, Forest Service, Pacific Southwest Research Station. 41 p.

Regional Ecosystem Office. 1995. Ecosystem analysis at the ecosystem level: federal guide for watershed analysis. ver. 2.2. Portland, OR: U.S. Department of Agriculture, Forest Service, Regional Interagency Executive Committee.

Regional Ecosystem Office, February 1997. Riparian Reserve Evaluation Techniques and Synthesis: Supplement to Section II of Ecosystem Analysis at the Watershed Scale: Federal Guide for Watershed Analysis. Version 2.2.

Rieger, John P. 1999. [Site visit]. August 18. San Diego, CA: State of California, Department of Transportation.

Rieger, John P. 2000. [E-mail]. July 17. San Diego, CA: State of California, Department of Transportation.

Rieger, John P.; Traynor, Ray. 1998. Restoration planning: an analytical approach. Workshop handbook. Austin, TX: Society for Ecological Restoration.

Rosgen, Dave. 1996. Applied river morphology. Pagosa Springs, CO: Wildland Hydrology.

Society for Ecological Restoration. 1994. Project policies. *Restoration Ecology*. 2(2): 132-133. [2000 August].

Society for Range Management. 1999. Glossary of terms used in range management. Denver, CO: Society for Range Management.

Soil Science Society of America. 1997. Glossary of soil science terms. Madison, WI: Soil Science Society of America.

Soil and Water Conservation Society. 2000. Soil Biology Primer. Ankeny, IA: Soil and Water Conservation Society, in cooperation with the U.S. Department of Agriculture, Natural Resources Conservation Service.

Stanley, John. 1999. Trail design in riparian corridors. Unpublished paper. Felton, CA: The Habitat Restoration Group, RRM Design Group.

Stanley, John. 2000. [Personal communication]. March 3. Reno, NV: Desert Research Institute.

Stanturf, John A.; Schoenholtz, Stephen H.; Schweitzer, Callie Jo; Shepard, James P. 2001. Achieving restoration success: myths in bottomland hardwood forests. *Restoration Ecology*. 9(2) June: 189-200.

Tanner, Linda, comp. 1997a. Native plant project summaries 1995-1997. U.S. Department of Agriculture, Forest Service, Umatilla National Forest, North Fork John Day Ranger District.

Tanner, Linda, comp. 1997b. Native plant program. U.S. Department of Agriculture, Forest Service, Umatilla National Forest, Walla Walla Ranger District.

The Habitat Restoration Group. No date. Glossary of terms pertaining to ecological restoration, land reclamation, and revegetation. Felton, CA: The Habitat Restoration Group.

Tjaden, Robert J.; Weber, Glenda M. No date. Riparian forest buffer design, establishment, and maintenance. College Park, MD: University of Maryland, Eastern Shore, Maryland Cooperative Extension; Fact Sheet 725.

Tucker, Elizabeth; Acree, Lisa; Fritzke, Sue; Johnson, Louise. 1998. Merced River restoration, Yosemite Valley 1991-1995. Inhouse report on file at U.S. Department of the Interior, National Park Service:Yosemite Research Library, Yosemite Valley, CA.

U.S. Department of Agriculture. No date. Stream Watch volunteer guidebook. Russian and Kenai River stream watch. Soldotna, AK: U.S. Department of Agriculture, Chugach National Forest. An interagency program. Stream Watch volunteers help protect resources by contacting visitors and talking with them about resource problems and how to reduce their impacts.

U.S. Department of Agriculture, Federal Stream Restoration Working Group. 1998. Stream corridor restoration, principles, processes, and practices. Washington, DC: U.S. Department of Agriculture: 8-16.

U.S. Department of Agriculture, Forest Service. 1989. Riparian area survey and evaluation system (RASES). Albuquerque, NM: U.S. Department of Agriculture, Forest Service, Southwest Region.

U.S. Department of Agriculture, Forest Service. 1995. [Letter to Kym Ganz]. April 18. Soldier Mountain desired condition statement – soils. Susanville, CA: U.S. Department of Agriculture, Forest Service, Lassen National Forest.

U.S. Department of Agriculture, Forest Service. 1996. Managing roads for wet meadow ecosystem recovery. FHWA-FLP-96-016. San Francisco: U.S. Department of Agriculture, Forest Service, Pacific Southwest Region.

U.S. Department of Agriculture, Forest Service. 1997. Land and resource management plan. R10-MB-338dd. Juneau, AK: U.S. Department of Agriculture, Forest Service, Tongass National Forest.

U.S. Department of Agriculture, Forest Service. 1997. Water/road interaction technology series

- An introduction. 9777 1805-SDTDC.
- Summary of historical and legal context for water/road interaction. 9777 1815-SDTDC.
- Glossary of water/road interaction terminology. 9777 1806-SDTDC.

Surface Drainage:

- Traveled way surface shape. 9777 1808-SDTDC.
- Relief culverts. 9777 1812-SDTDC.
- The X-DRAIN cross drain spacing and sediment yield model (with CD). 9877 1801-SDTDC.
- Cross drain update. 9877 1804-SDTDC.

- Water/road interaction: introduction to surface cross drains. 9877 1806-SDTDC.
- Water/road interaction: examples of three flood assessment sites in western Oregon. 9877 1805-SDTDC.
- Minimizing low volume road water displacement. 9977 1804-SDTDC.

#### Subsurface Drainage:

- A monitoring system for measuring effects of roads on groundwater: equipment and installation. 9777 1804-SDTDC.
- Measuring effects of roads on groundwater: five case studies. 9977 1801-SDTDC.

#### Drainage Crossings:

- Field indicators of inlet controlled road stream crossing capacity. 9777 1807-SDTDC.
- Diversion potential at road-stream crossings. 9777 1814-SDTDC.
- Road-stream crossing passage questionnaire. 9777 1813-SDTDC.
- Response of road-stream crossings to large events in Washington, Oregon, and northern California. 9877 1806-SDTDC.
- Methods for inventory and environmental risk assessment of road drainage crossings. 9877 1809-SDTDC.
- A guide to computer software tools for culvert design and analysis. 9977 1806-SDTDC.

#### Bibliography:

- Water/road interaction: an annotated bibliography. 9777 1816-SDTDC.

San Dimas, CA: U.S. Department of Agriculture, Forest Service, San Dimas Technology and Development Center.

U.S. Department of Agriculture, Forest Service, Boise National Forest. 1998. Dispersed recreation site condition inventory and mapping project report 1997-1998. Boise, ID.

U.S. Department of Agriculture, Natural Resources Conservation Service. 1996. In: Engineering field handbook, chapter 16. Streambank and shoreline protection, appendix 12B. Washington, DC.

U.S. Department of Agriculture, Natural Resources Conservation Service. 2001. Stream corridor inventory and assessment technique. A guide to site, project and landscape approaches suitable for local conservation programs.

U.S. Department of Agriculture, Forest Service; U.S. Department of the Interior, Bureau of Land Management. 1995. Decision notice/decision record, finding of no significant impact, environmental assessment for the interim strategies for managing anadromous fish-producing watersheds in eastern Oregon and Washington, Idaho, and portions of California (PACFISH). Washington, DC.

U.S. Department of the Interior, Bureau of Land Management, Partners in Flight, Boise, ID. No date. Birds as indicators of riparian vegetation condition in the western United States. Jamestown, ND: U.S. Department of the Interior, Bureau of Land Management, Northern Prairie Wildlife Research Center; BLM/ID/PT-98/004 + 6635. Available: <http://www.npwrc.usgs.gov/resource/1998/ripveg/ripveg.htm> (Version 15DEC98).

U.S. Department of the Interior, Bureau of Land Management. 1992. Procedures for ecological site inventory—with special reference to riparian-wetland sites. TR-1737-3. U.S. Department of the Interior, Bureau of Land Management.

U.S. Environmental Protection Agency. 1998. Clean water action plan: restoring and protecting America's waters. EPA-840-R-98-001. U.S. Environmental Protection Agency, National Center for Environmental Publications and Information.

Vermont Department of Environmental Conservation. 1997. Local planning and zoning options for water quality protection. Waterbury, VT: Vermont Department of Environmental Conservation, Agency of Natural Resources, Water Quality Division.

Ward, Roy C. 1975. Principles of hydrology, 2<sup>nd</sup> edition. UK: McGraw-Hill.

Weaver, T.; Dale, D. 1978. Trampling effects of hikers, motorcycles and horses in meadows and forests. *Journal of Applied Ecology*. 15(2): 451-457.

Webster's Third New World Dictionary. 1986. Springfield, MA: Merriam-Webster.

Williams, Jack; Wood, Christopher A.; Dombek, Michael P., eds. 1997. Watershed restoration: principles and practices. Bethesda, MD: American Fisheries Society.

Williams, R.; Zielinski, E. 1997. Interior Columbia Basin Ecosystem Management Project: eastside draft environmental impact statement preferred alternatives. Washington, DC: U.S. Department of Agriculture, Forest Service; U.S. Department of the Interior, Bureau of Land Management.

Winward, Alma H. 2000. Monitoring the vegetation resources in riparian areas. Gen. Tech. Rep. RMRS-GTR-47. Ogden, UT: U.S. Department of Agriculture, Forest Service, Rocky Mountain Research Station.

Zabinski, Catherine; Cole, David. 2000. Understanding the factors that limit restoration success on a recreation-impacted subalpine site. In: Cole, David N.; McCool, Stephen F.; Borrie, William T.; O'Loughlin, Jennifer, comps. *Wilderness science in a time of change conference Vol 5: Wilderness Ecosystems, Threats, and Management*. 1999 May 23-27; Missoula, MT. Proc. RMRS-P-15-VOL-5. 216-221. Ogden, UT: Department of Agriculture, Forest Service, Rocky Mountain Research Station.



