

Detection and characterization of subsurface dissolved hydrocarbon plumes by *in situ* mass spectrometry – A demonstration in the natural laboratory of the Coal Oil Point seep field.

Ira Leifer^{1,2}, Tim Short³, Scott Hiller⁴, Michael Suschikh¹

¹Bubbleology Research International

²University of California, Santa Barbara

³SRI international

⁴Terrasond, Ltd

Mission Goals

1. Identify dissolved components under surface oil slicks.
2. Identify and characterize dissolved oil component plumes.
3. Use sidescan sonar to characterize plume source.
4. Test conventional fluorometric detection of dissolved and submerged oil

(on a shoestring budget)

How a MIMS works

in situ Membrane Introduction Mass Spectrometer

Dissolved gas transfer across a semipermeable membrane from a sample water flow provides sample into the mass spectrometer for analysis

Gases breakup into known fragments, which then are used to identify the incoming gases.

Key to calibration is reduction of water vapor from the gas stream entering the mass spectrometer

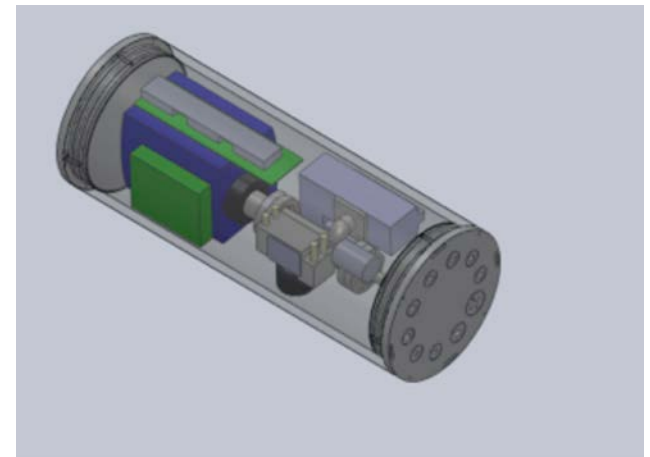

Introduction of Analytes from the Water Column

- MIMS is ideal
 - Passive (except for sample pumping and heating, if desired)
 - Polydimethylsiloxane (PDMS) or Teflon are most common choices (hydrophobic)
 - Provides sensitive detection of dissolved gases and volatile organic compounds
- Need to mechanically support membrane (hydrostatic pressure)
 - Porous metal or ceramic frit

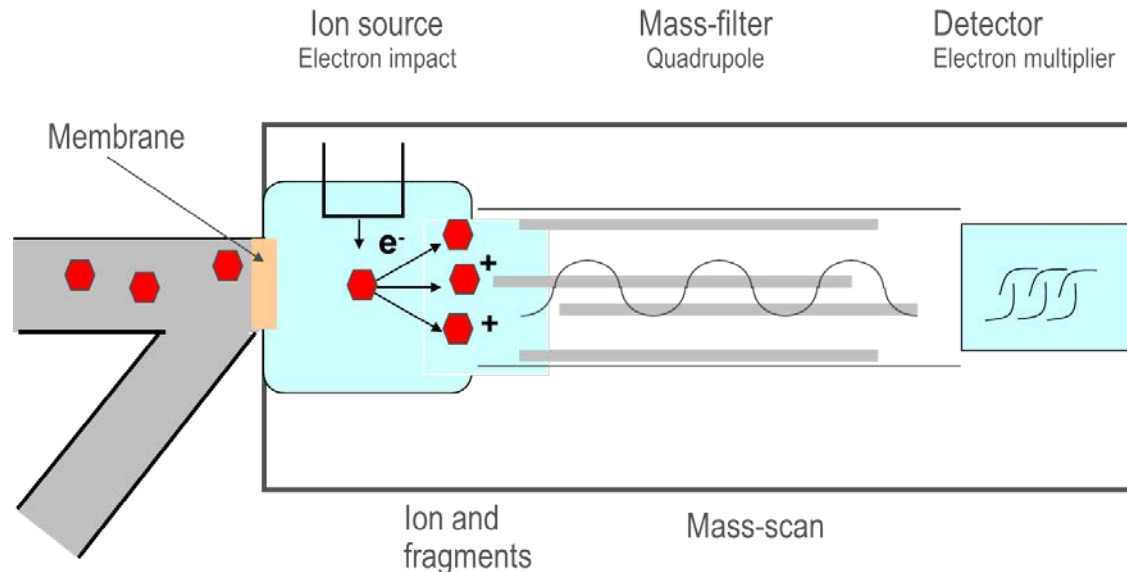

SRI MIMS Adapted for Underwater In Situ Analysis

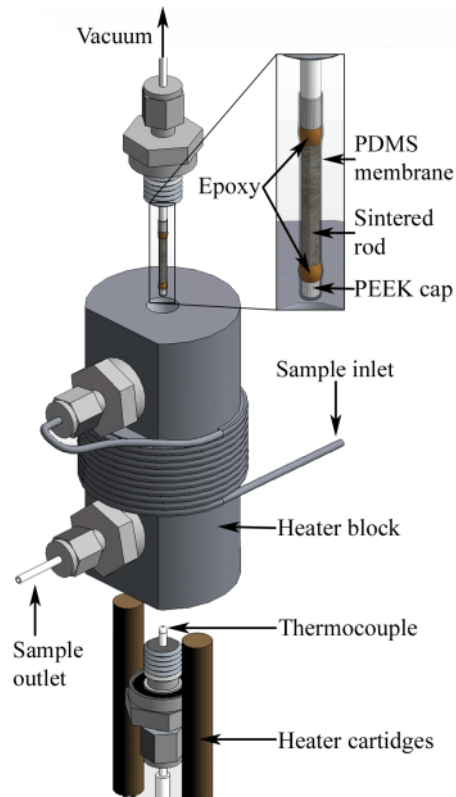

High pressure membrane interface



- Microcontroller
- Embedded PC and other electronics
- MS electronics (Inficon CPM 200)
- 200 amu linear quadrupole in vacuum housing w/ heating jacket
- Turbo pump (Varian/Agilent V81-M)
- MIMS probe
- Roughing pump (KNF Neuberger)

Portable Underwater Mass Spectrometry

- Simultaneous *in situ* quantification of multiple analytes
 - Dissolved gases
 - Light hydrocarbons
 - Volatile organic compounds
- High pressure, direct sample introduction
 - *Under development*
 - Explosives
 - CW agents
 - Pesticides and other pollutants

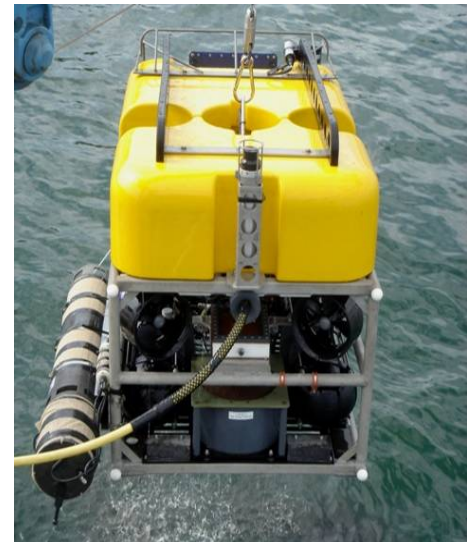

In Situ Analysis Advantages

- Reduced sample contamination
- Increased sampling speed/density
- Sample hazardous environments
- Real-time feedback
 - Rapid response
 - Adaptive sampling
 - Gradient mapping
- Self-directed sensors



Mass spectrometry allows sensitive simultaneous detection of multiple chemical species with high specificity

In-Water Chemical Measurements and Inspections

- Establish background levels of hazardous compounds
 - Underwater surveys on manned or unmanned vehicles
- Detect elevated concentrations of leaking chemicals
 - Time series monitoring
 - Periodic surveys (AUV, ROV, or R/V)
- Inspect suspected leaks
 - ROV survey of location
 - Real-time feedback to find source
- Determine ecosystem health
 - Time series or surveys
 - Monitor oxygen, carbon dioxide, and other important biogeochemical chemicals



Typical MIMS Diagnostic Ions

M/Z VALUE	COMPOUND	ISOTOPIC FORM
15	Methane (CH ₄)	¹² CH ₃ Fragment
28	Nitrogen (N ₂)	¹⁴ N ¹⁴ N
30	Ethane (C ₂ H ₆)	Various
32	Oxygen (O ₂)	¹⁶ O ¹⁶ O
34	Oxygen (O ₂) Hydrogen Sulfide (H ₂ S)	¹⁶ O ¹⁸ O H ₂ ³² S
39	Propane (C ₃ H ₈)	Various
40	Argon (Ar)	⁴⁰ Ar
44	Carbon Dioxide (CO ₂)	¹² C ¹⁶ O ¹⁶ O
58	Butane (C ₄ H ₁₀)	Various
78	Benzene (C ₆ H ₆)	Various
92	Toluene (C ₇ H ₈)	Various
106	Xylene (C ₈ H ₁₀)	Various
128	Naphthalene (C ₁₀ H ₈)	Various

- Full mass scans or selected ion monitoring
- A total of 40 m/z values can be monitored with a cycle time of ~ 7 sec

The Best Diagnostic Ions Often are not the most Intense

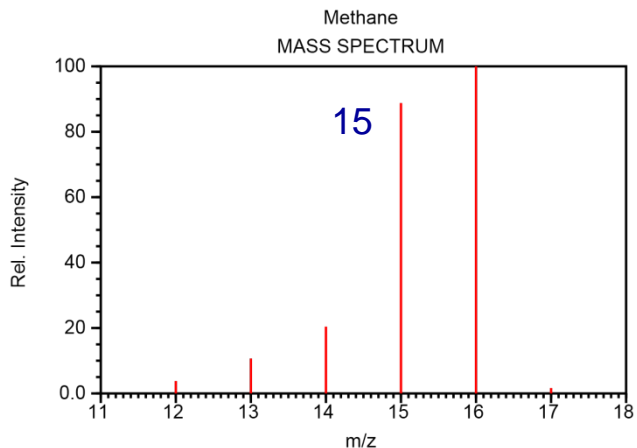

NIST Chemistry WebBook (<http://webbook.nist.gov/chemistry>)

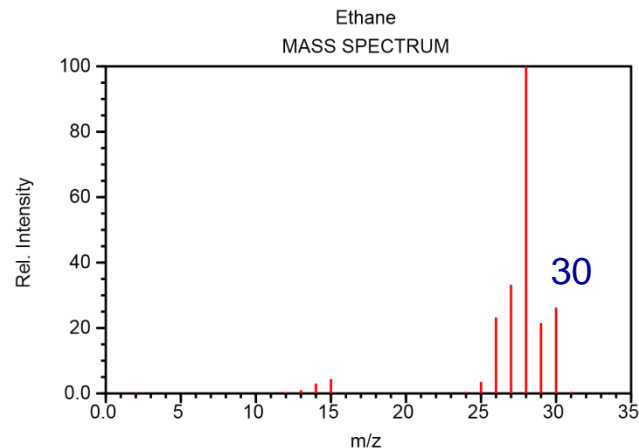

NIST Chemistry WebBook (<http://webbook.nist.gov/chemistry>)

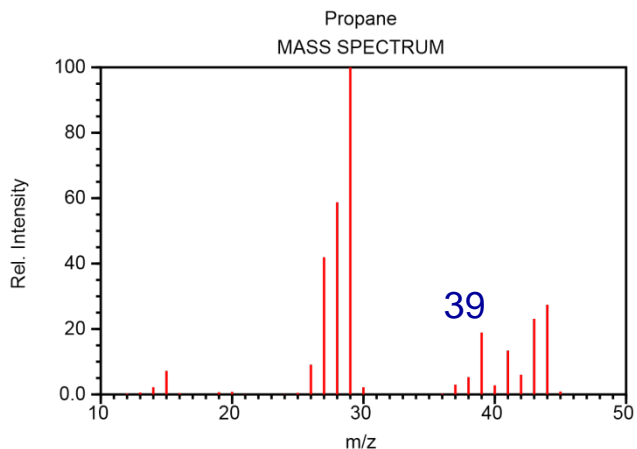

NIST Chemistry WebBook (<http://webbook.nist.gov/chemistry>)

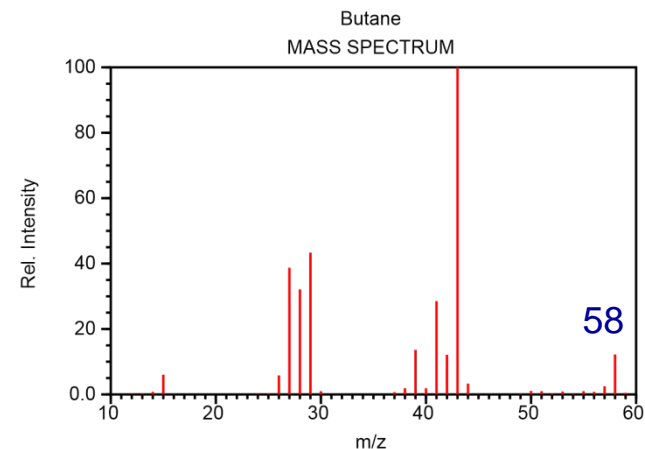

NIST Chemistry WebBook (<http://webbook.nist.gov/chemistry>)

NIST Electron Impact Mass Spectra of Hydrocarbons

Louisiana Crude Reference Oil Dissolved in Water

10 ppm

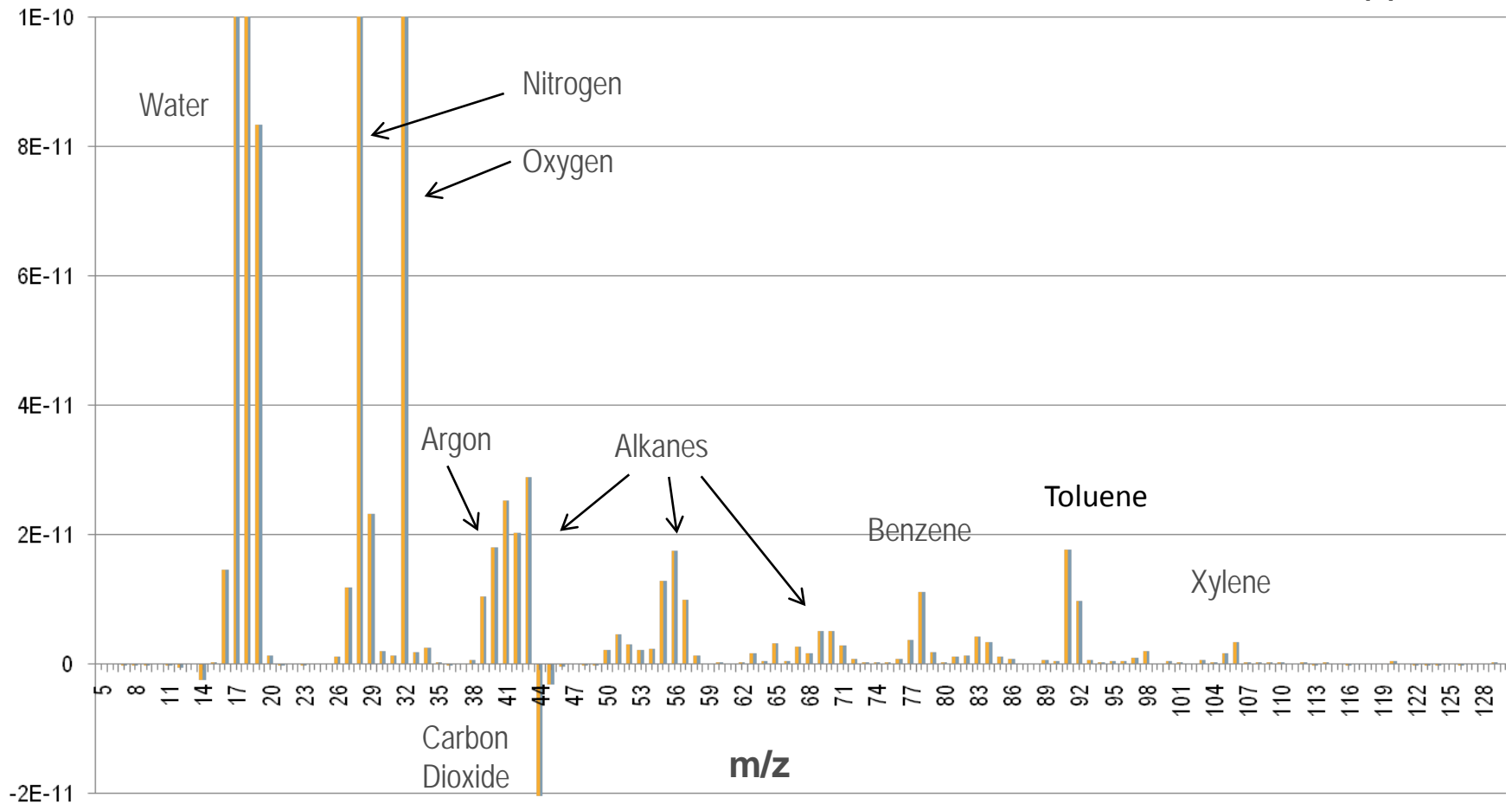

Background Subtracted MIMS Spectrum

In Situ MIMS Calibration

- Physical parameters that affect instrument response:

- Detector settings
- Filament settings
- Membrane geometry

Constant during short deployments

- Residual gas
- Membrane temperature
- Sample velocity

Try to keep constant during deployment

- In situ temperature
- Hydrostatic pressure
- Sample salinity

Variable during deployment (measure and calibrate)

MIMS Measurements: Calibration Procedure

- Equilibrate gas mixtures with seawater
- Record MIMS response at designated m/z values
- Least squares linear fit relates gas concentration and MIMS response
- Subtract known background contributions
- Correct field data for compression of the membrane (hydrostatic pressure) – Ar or H₂O

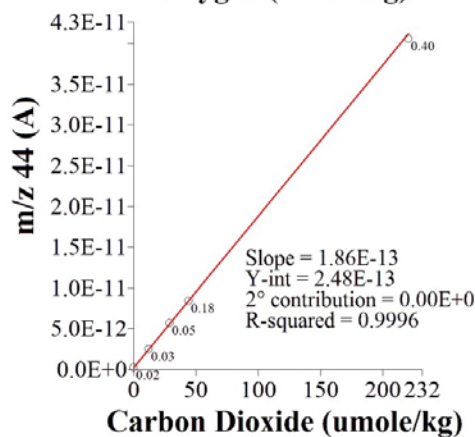
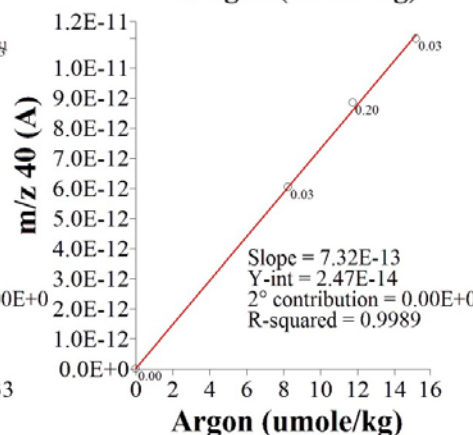
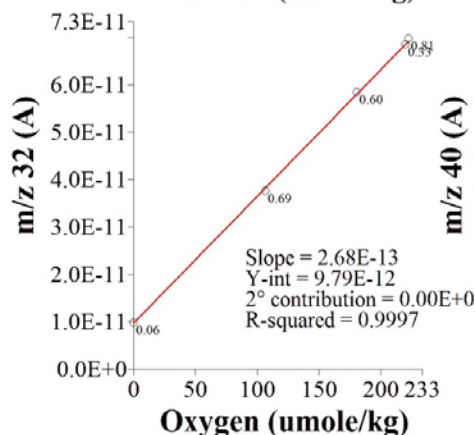
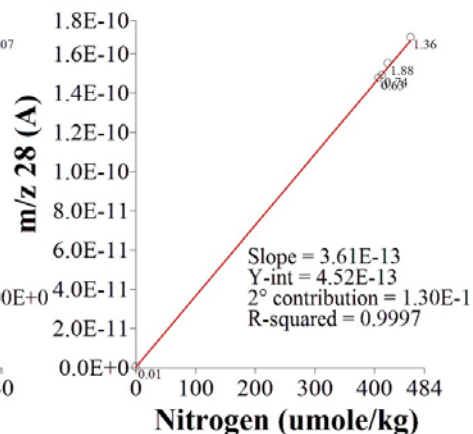
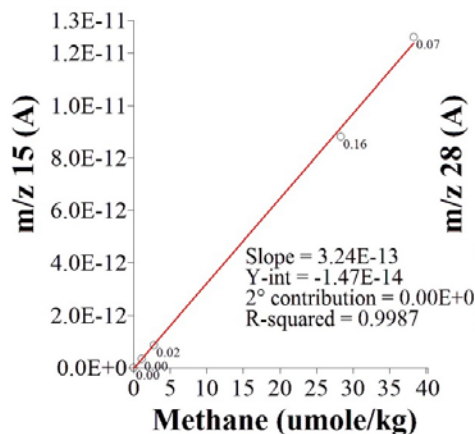

* CAL2_CSA_Sel_Mon_FC_Alkanes_Gases_VOCs-1_000.txt
 * Faraday Cup Mode
 * Multiregression performed on N2 using m/z 44
 * Regression is weighted by std. dev.
 * Values reported next to data points are 3x std dev. (in umole/kg)

Field Campaign Details

- Air pumped water to boat from depths to 50 m, tethered to the onboard MIMS, fluorometer, and sample stream for archive bottle samples.
- Focused vertical study at Trilogy Seep (as a Rosette).
- Focused study of downcurrent plume from Seep Tent Seep. (this talk).
- Downcurrent plume surveyed with a pole-mounted sample lines from 2 m depth.
- Survey zigzagged across the downcurrent plume, using MIMS methane channel to guide sample collection.

Spill Scientists' Playground

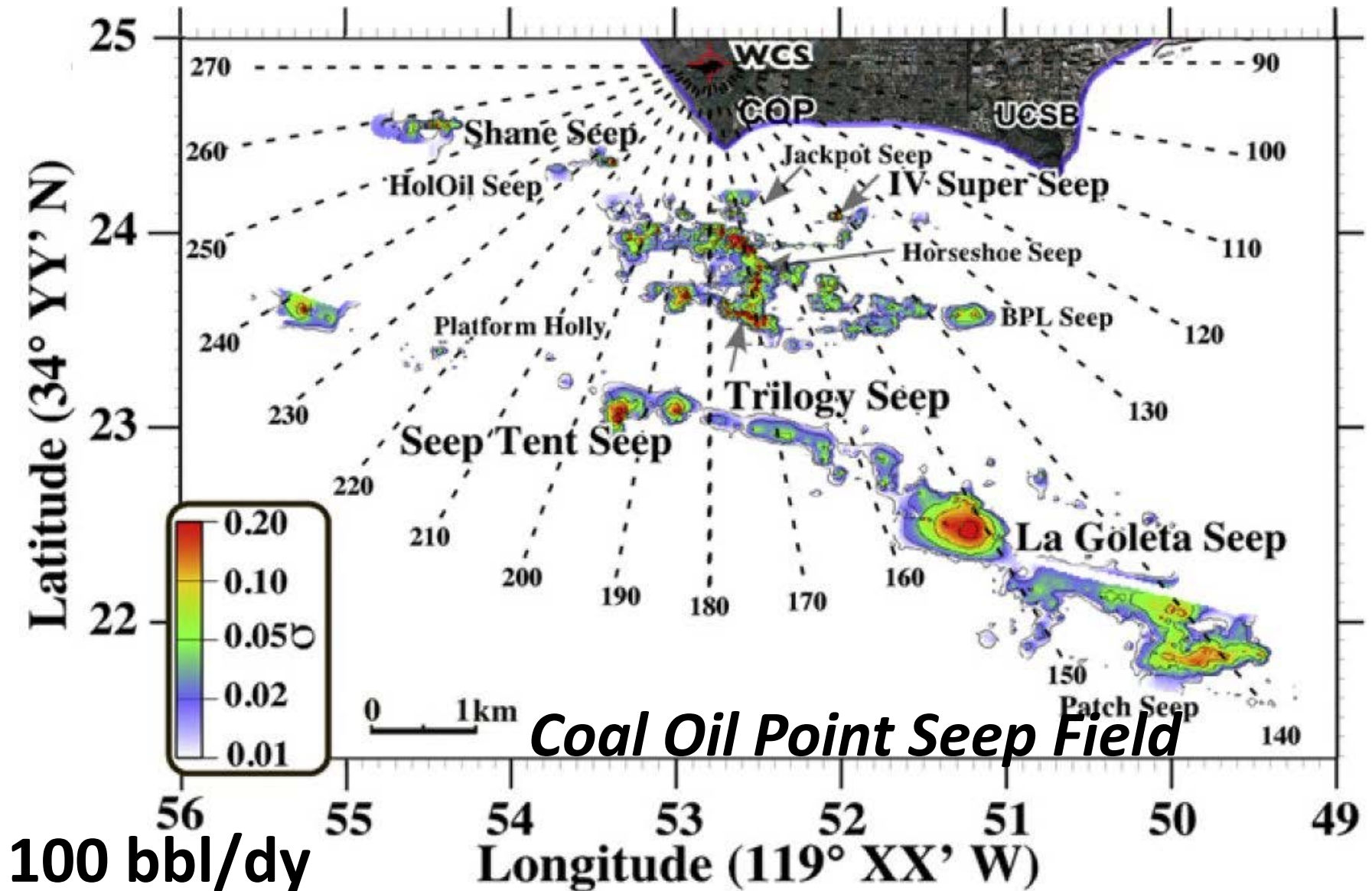

Coal Oil Point Seep Field

100 bbl/dy

$10^5 \text{ m}^3/\text{dy}$ Gas

Spill Scientists' Playground

The Coal Oil Point seep field - a natural laboratory to test data strategies, evaluate instrumentation performance function, and learn !!!.

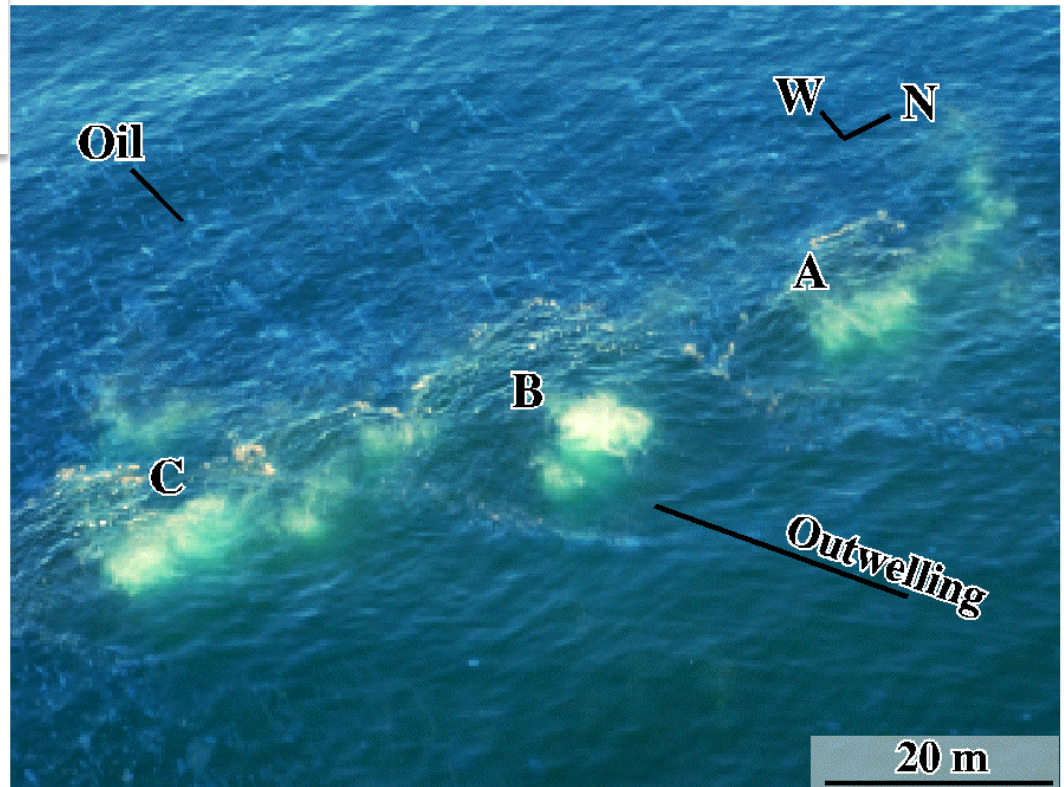
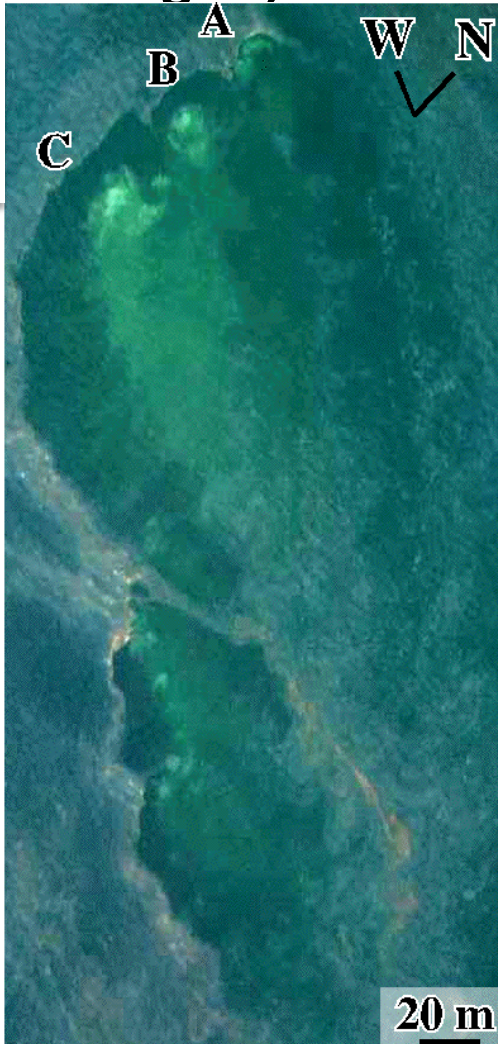

Some Plume Processes

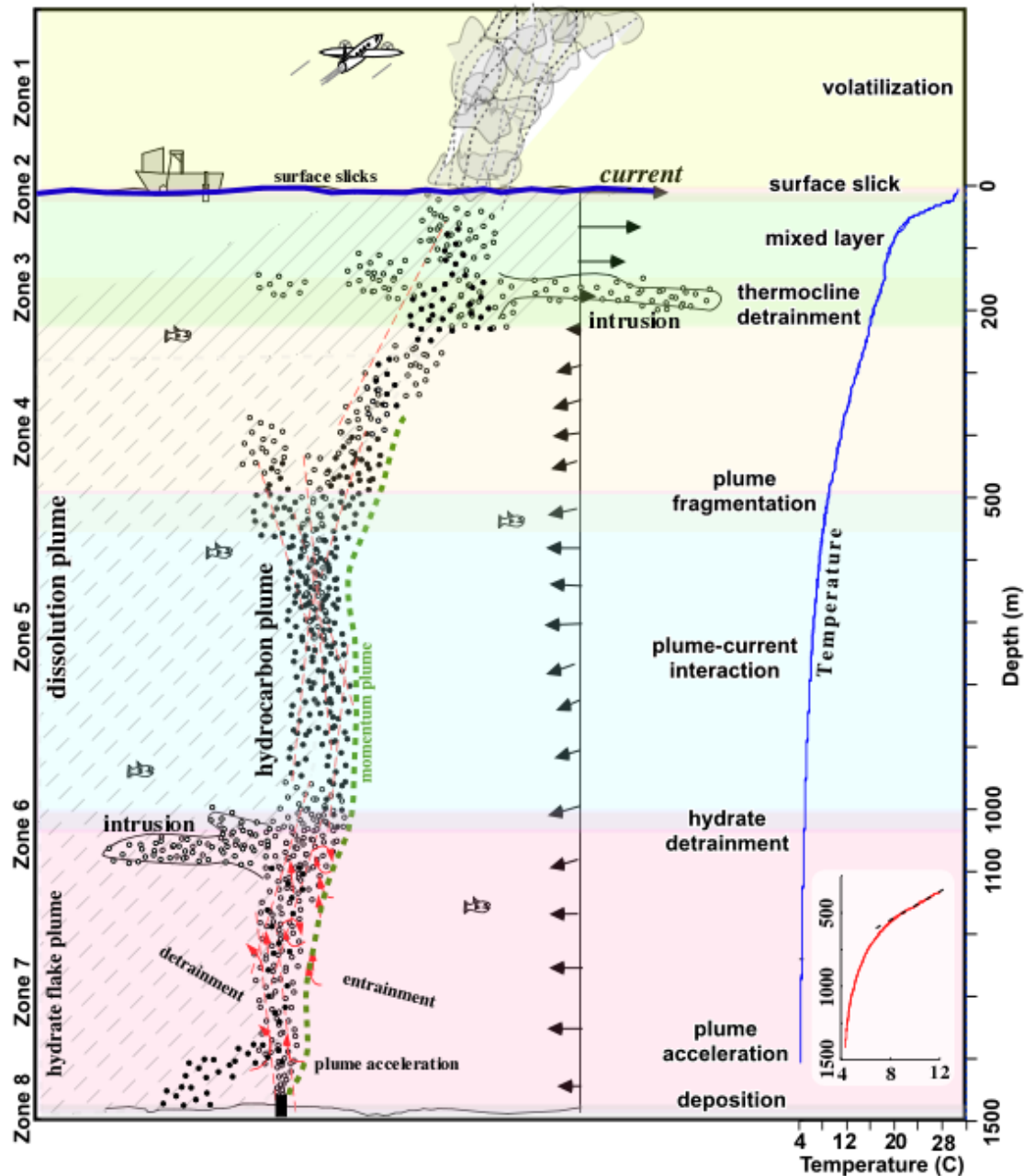

Seep Tent Seep Plume Profiling : Propane, Butane, Pentane

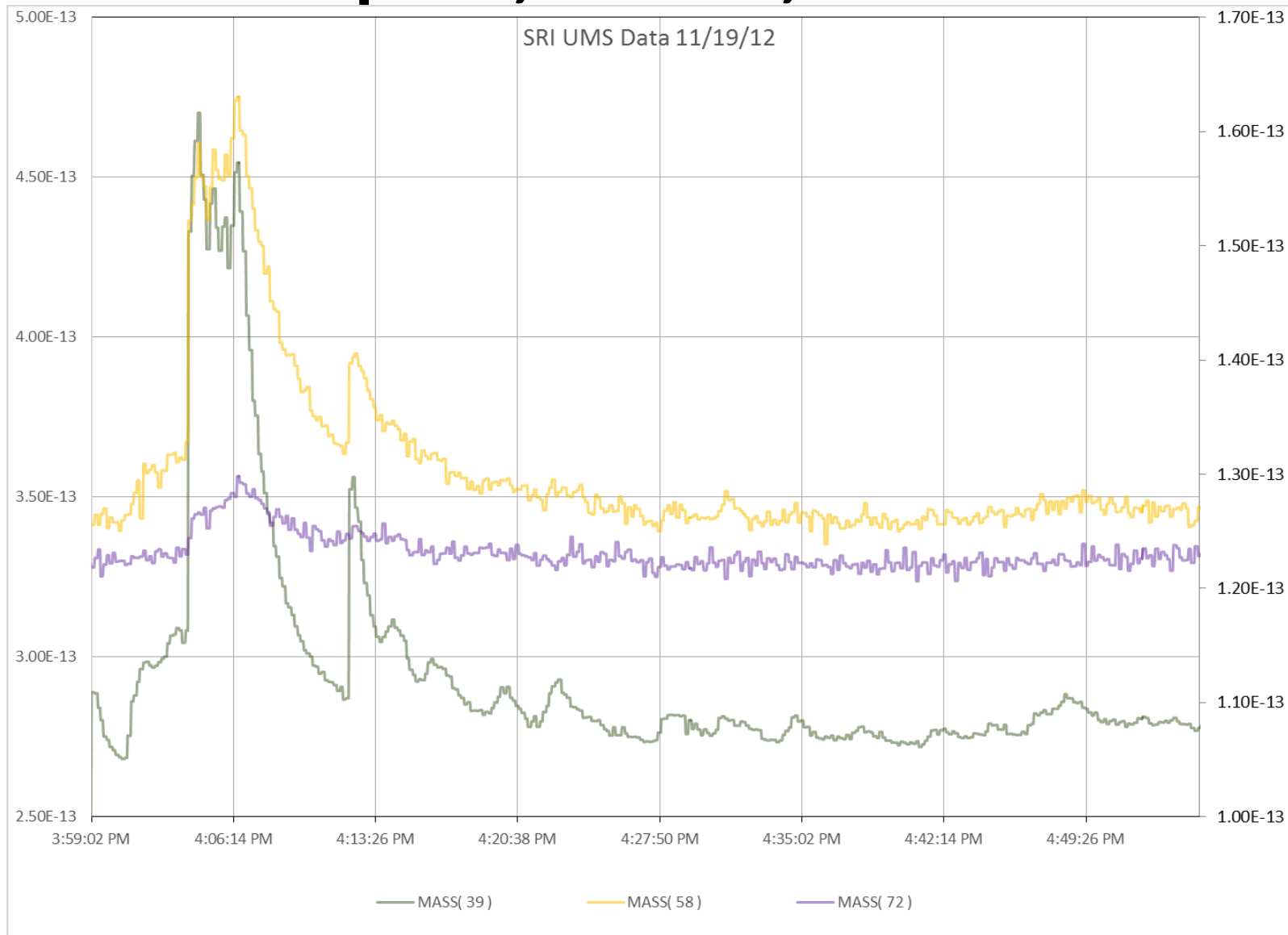

Seep Tent Seep Plume Methane

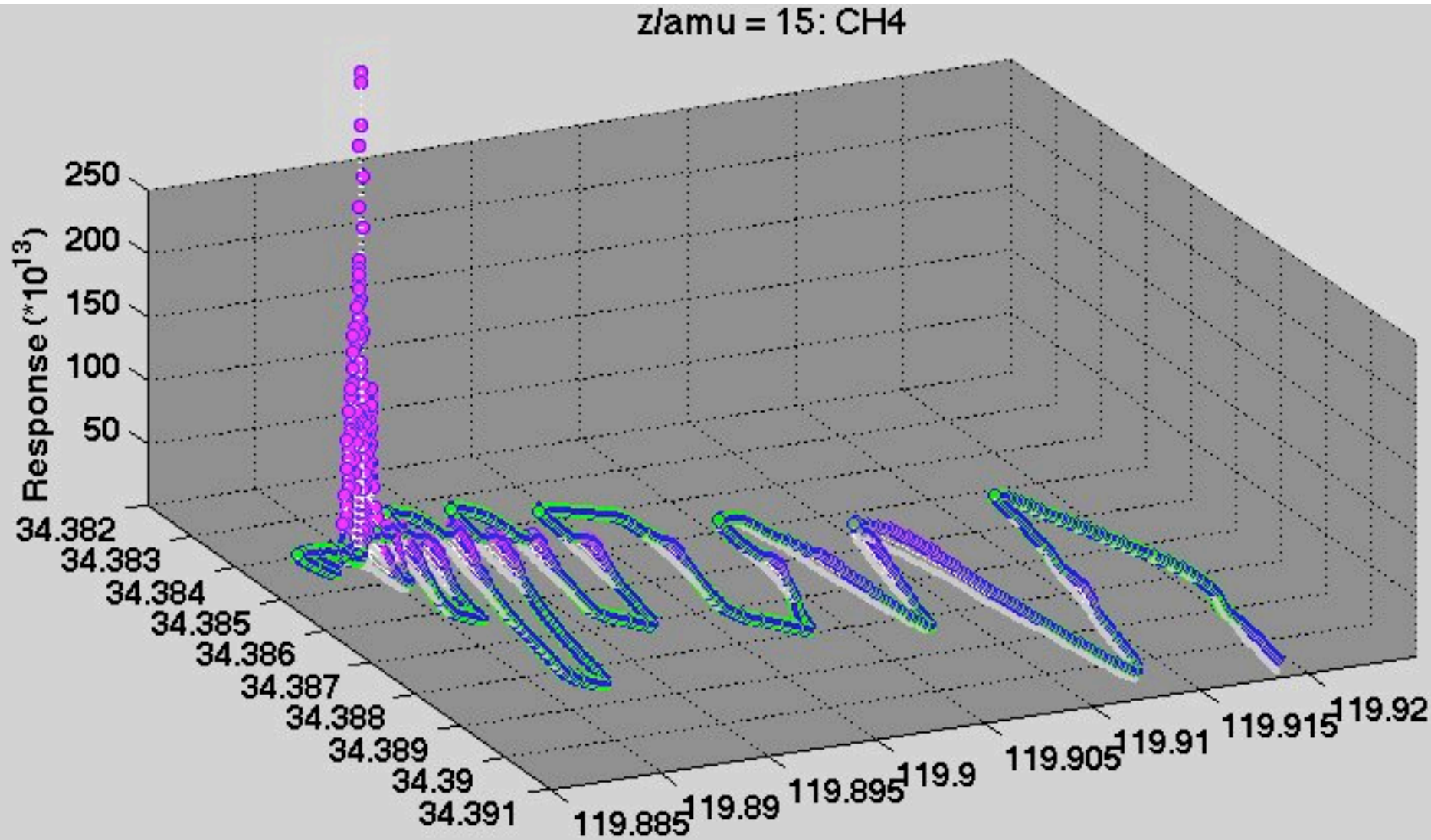

Characteristic main-plume width depends on surface bubble dissolution and upwelling fluid transport. Downcurrent plume affected by dissolution, and vertical and horizontal diffusion and outgassing through the sea surface.

Seep Tent Seep Plume Ethane

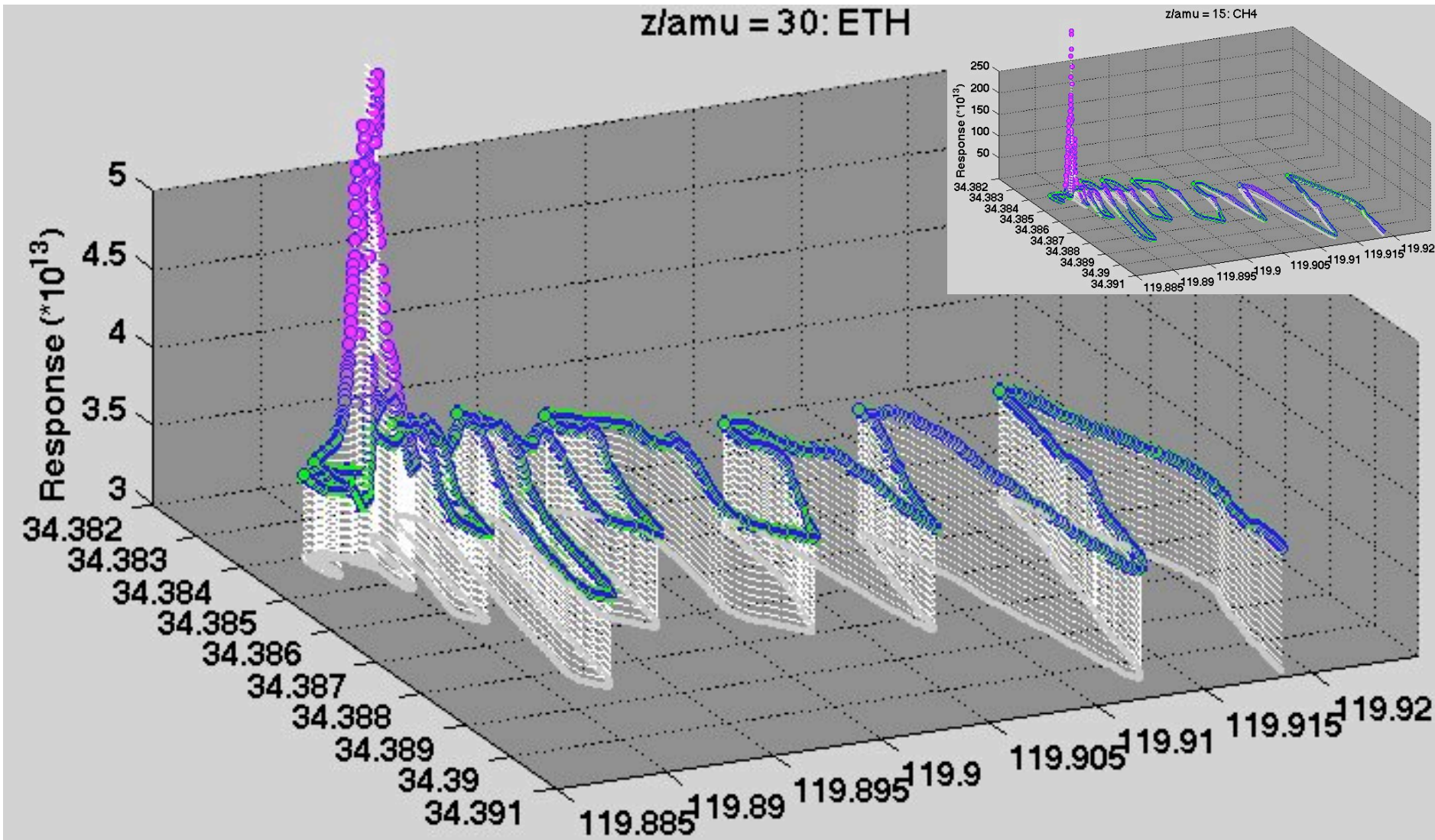

Characteristic main-plume width depends on surface bubble dissolution and upwelling fluid transport. Downcurrent plume clearly visible.

Seep Tent Seep Plume Propane

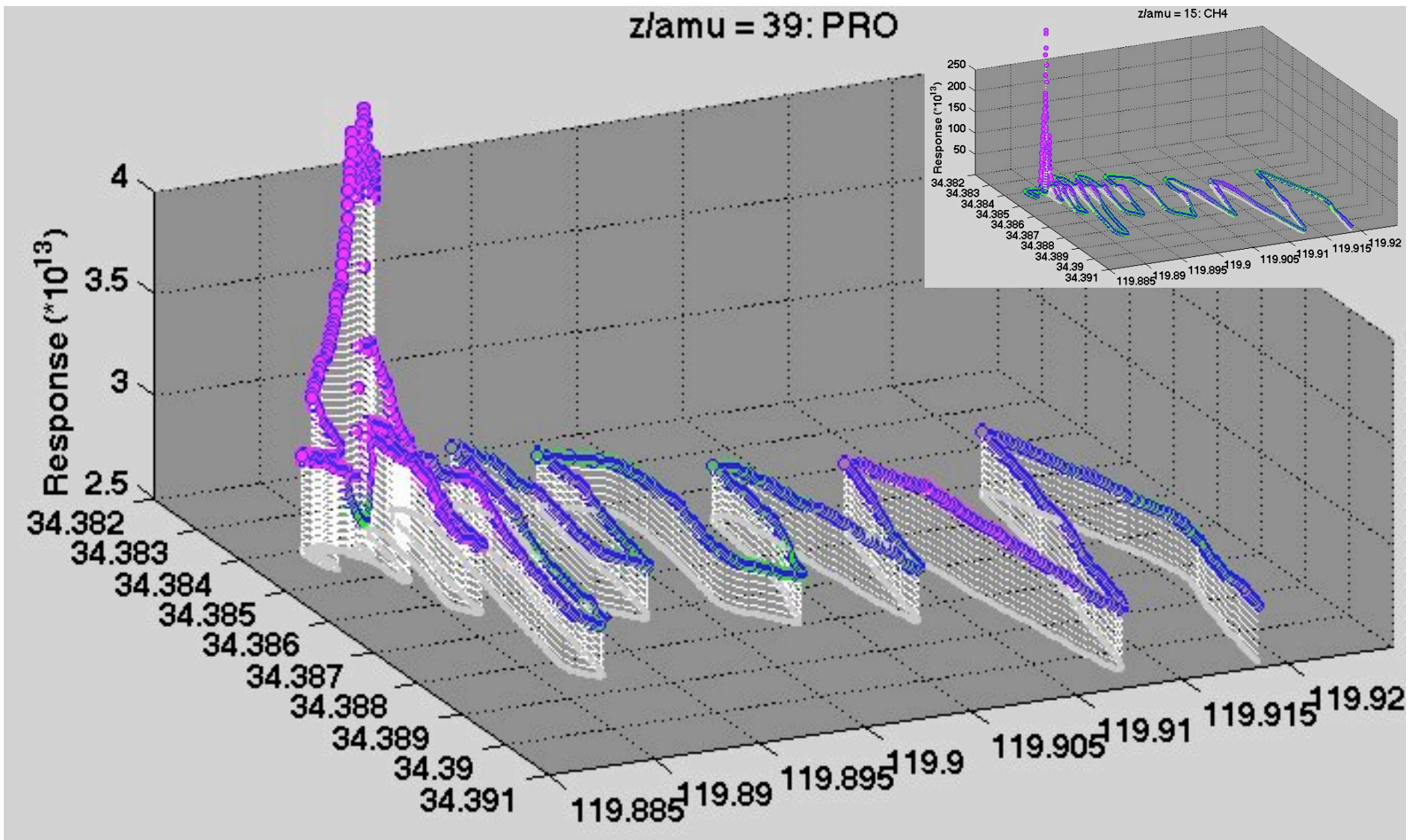

Plume still evident. Surface plume characteristic width is broader. This could be due to oil outgassing – the effect of upwelling should be most important for methane compared to larger molecules.

Seep Tent Seep Plume Butane

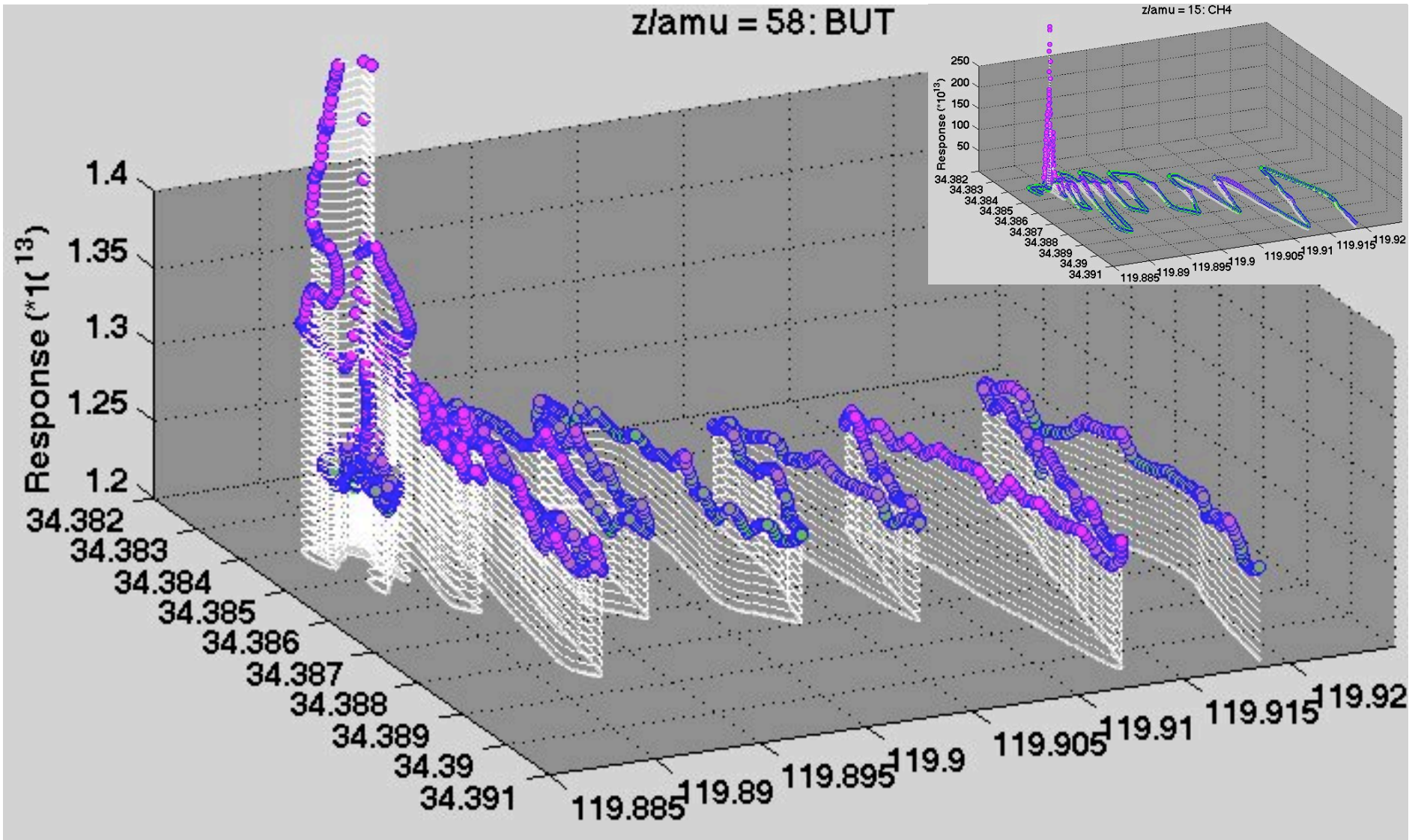

Plume still apparent but noise is significant. Plume characteristic width is broader. This could be due to outgassing of oil – the effect of upwelling should be most important for methane.

Seep Tent Seep Plume Benzene

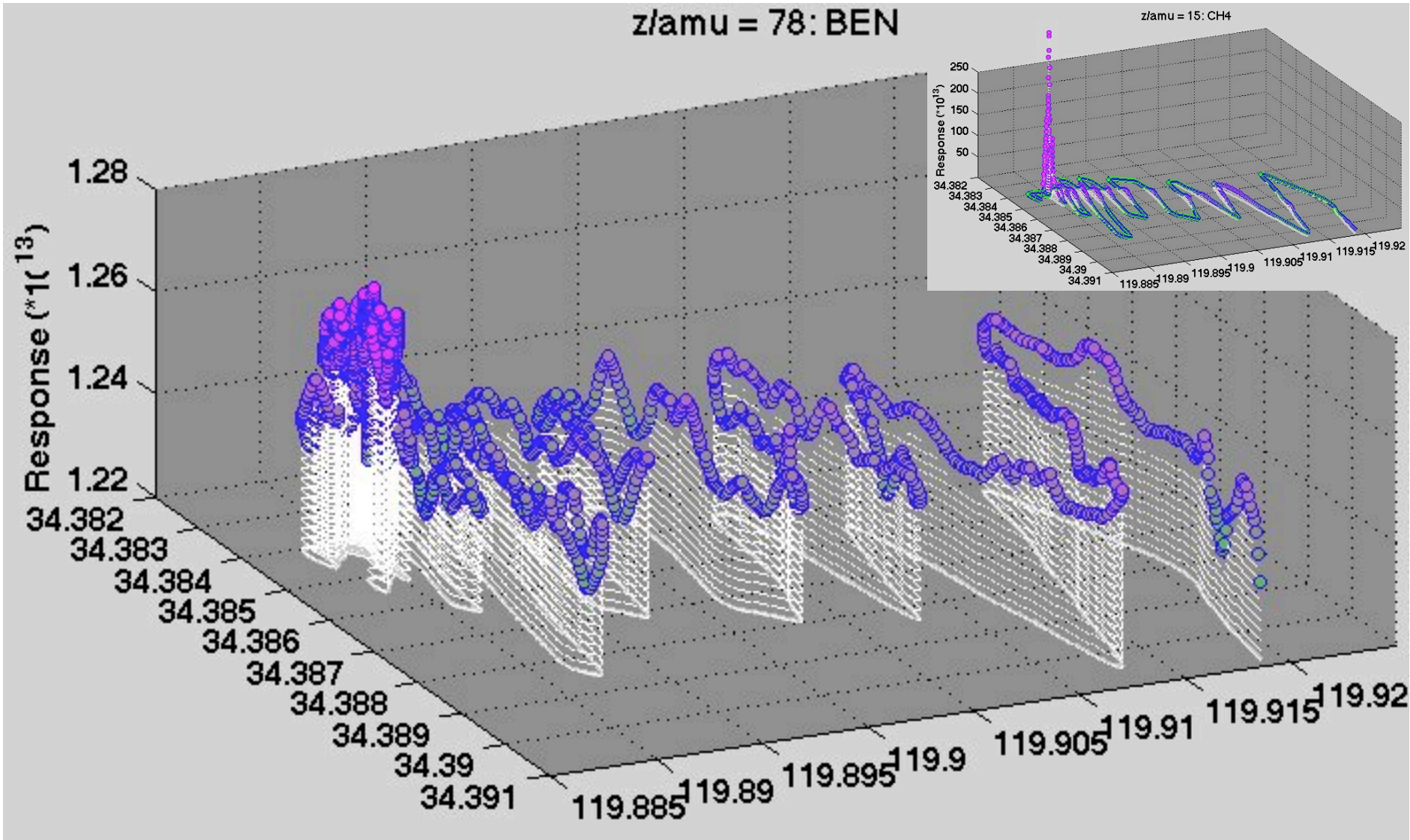

Plume apparent for this lightest fluorescent compound. Plume characteristic width is broad and “flat”, which is consistent with oil outgassing. Some suggestion of downcurrent plume structure (possibly from slicks).

Seep Tent Seep Plume Toluene

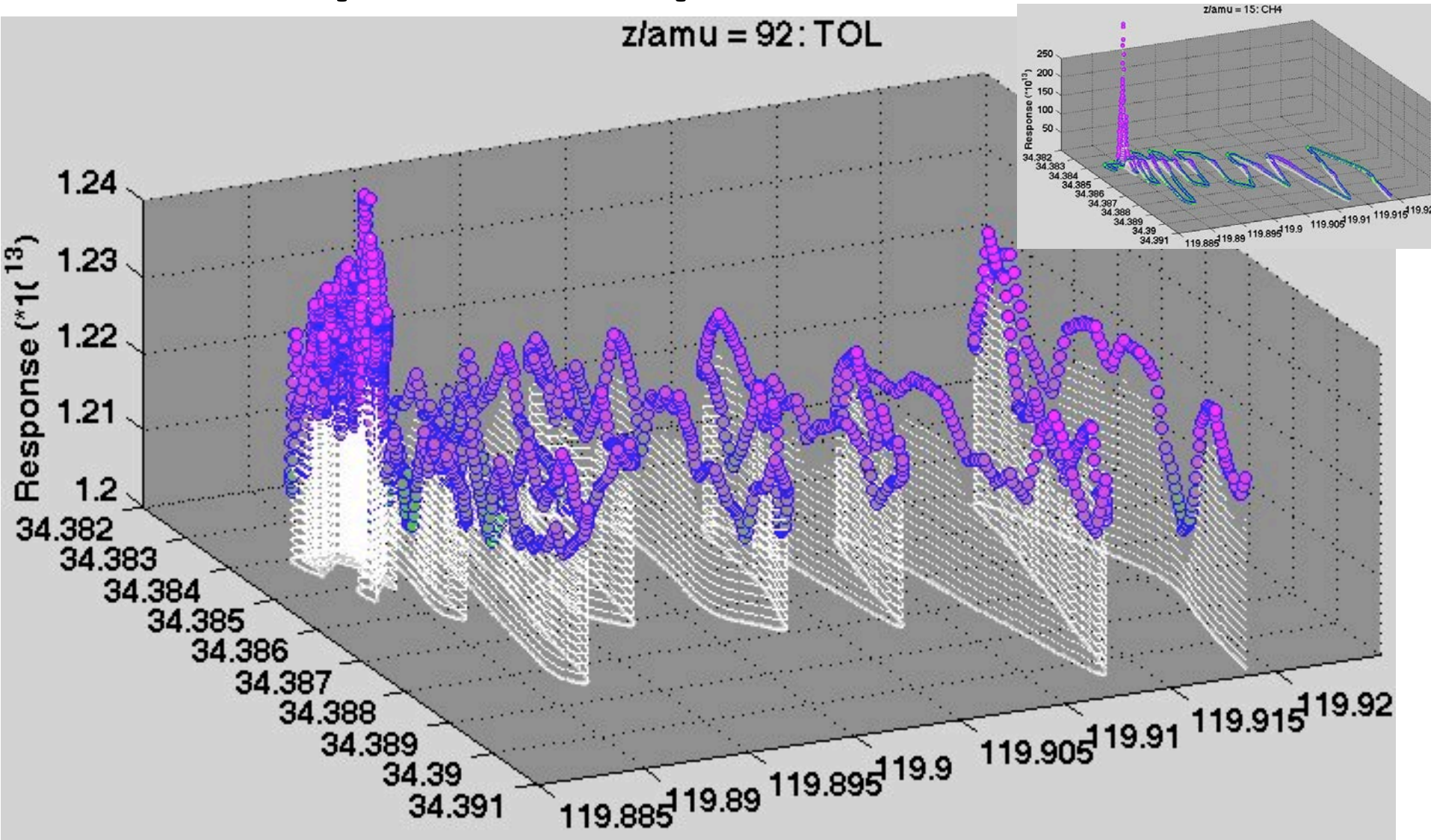

Main plume still apparent, but less noise and similar fine-scale structure as butane, suggesting that for toluene, greater upwelling importance. Downcurrent plume shows some of the same characteristics as benzene and butane, not propane.

Seep Tent Seep Plume Pro,But,Benz,Tol

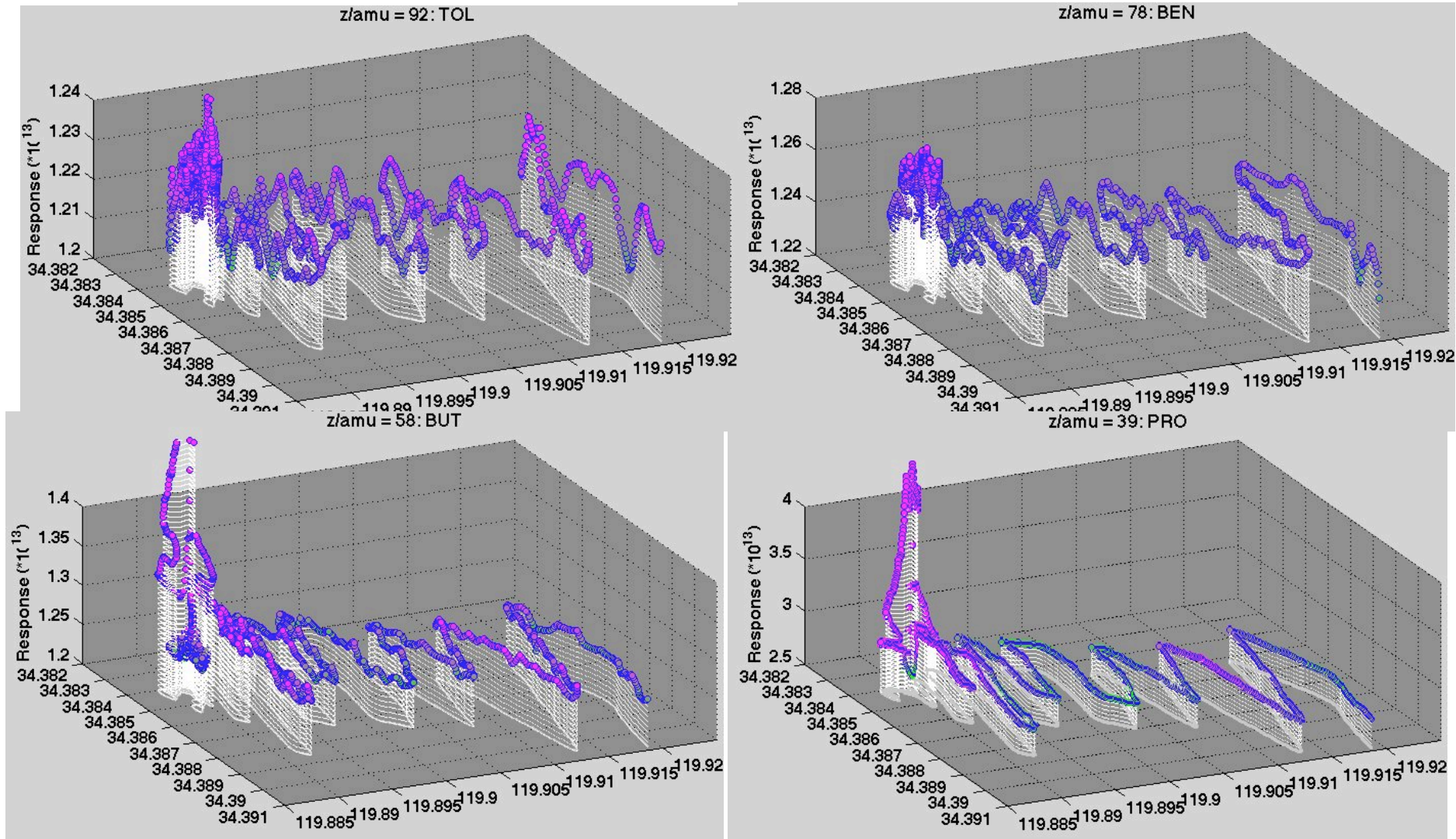

Main plume still apparent, but less noise and similar fine-scale structure as butane, suggesting that for toluene, greater upwelling importance. Downcurrent plume shows some of the same characteristics as benzene and butane, not propane.

Seep Tent Seep Plume Oxygen

z/lamu = 32: Oxy

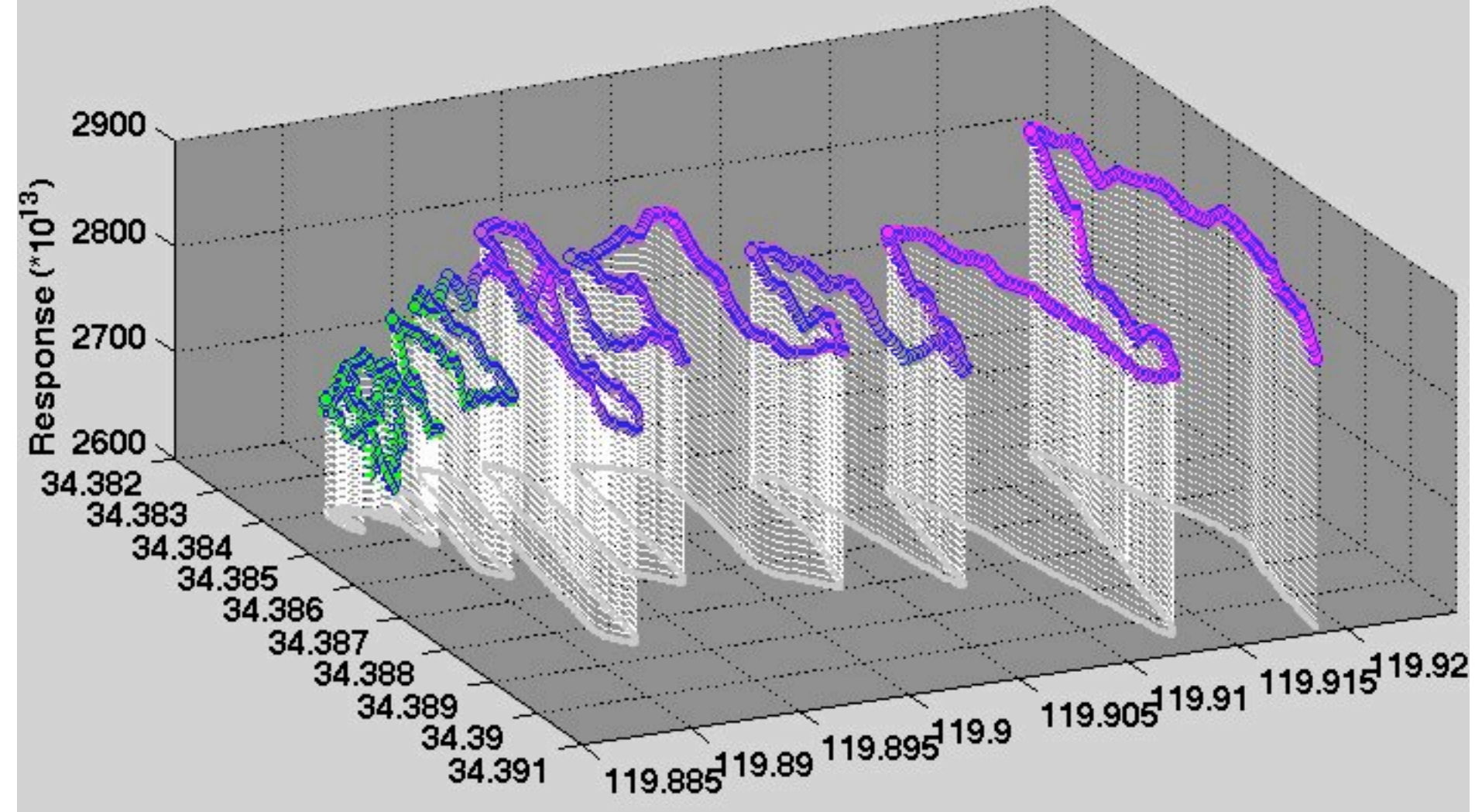

Bubbles remove oxygen (and other dissolved air gases from plume). Upwelling plume effect clearly is apparent in near field plume due to mixing.

Seep Tent Seep Plume Carbon Dioxide

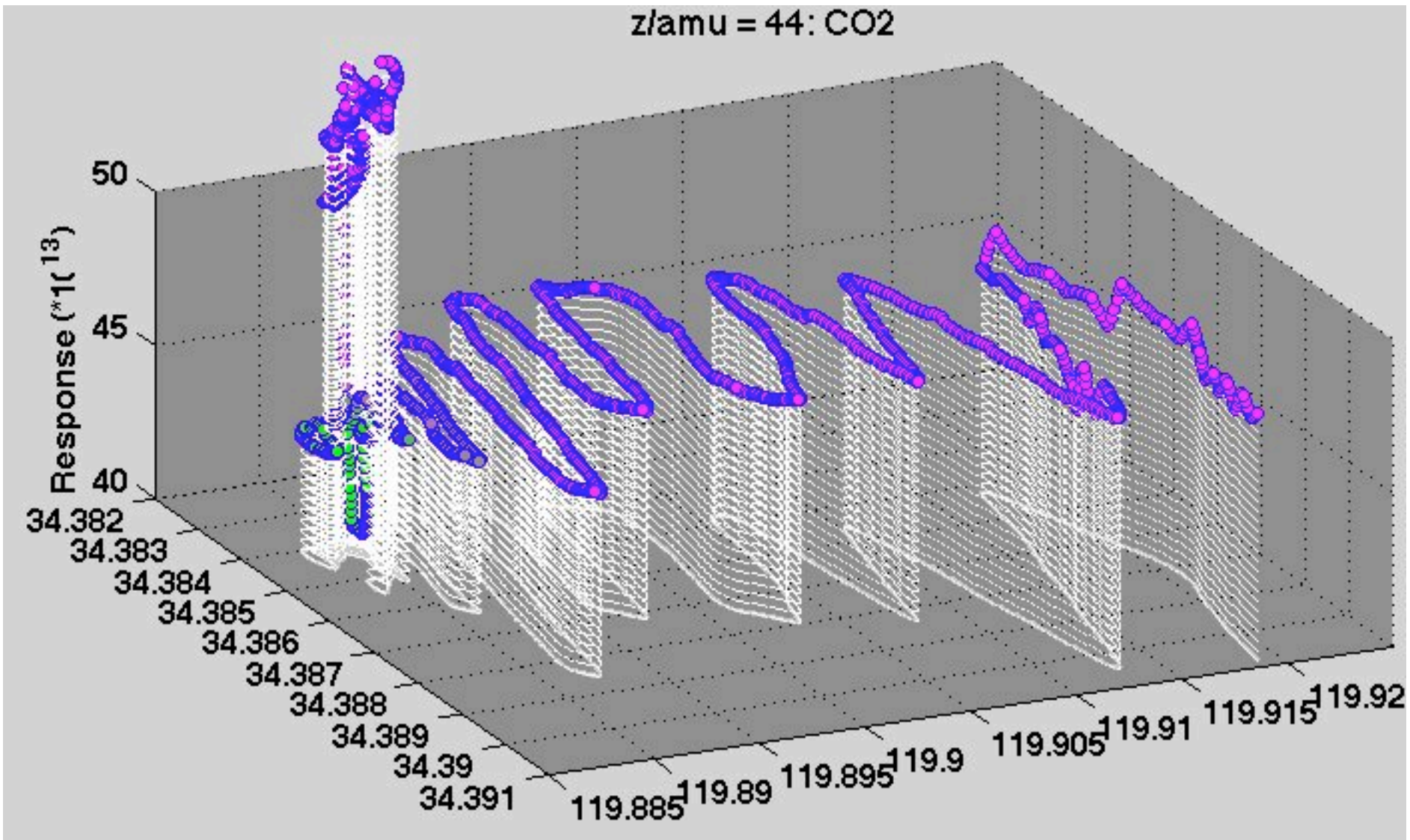

Carbon dioxide dissolves extremely quickly, so this shows only the deepest fluid upwelling flow and also dissolution from the largest bubbles. Dissimilarity with other upwelling dominated gases suggests the latter. Bubbles also remove ambient dissolved CO₂, note near field recovery.

Seep Tent Seep Plume Methane (near field)

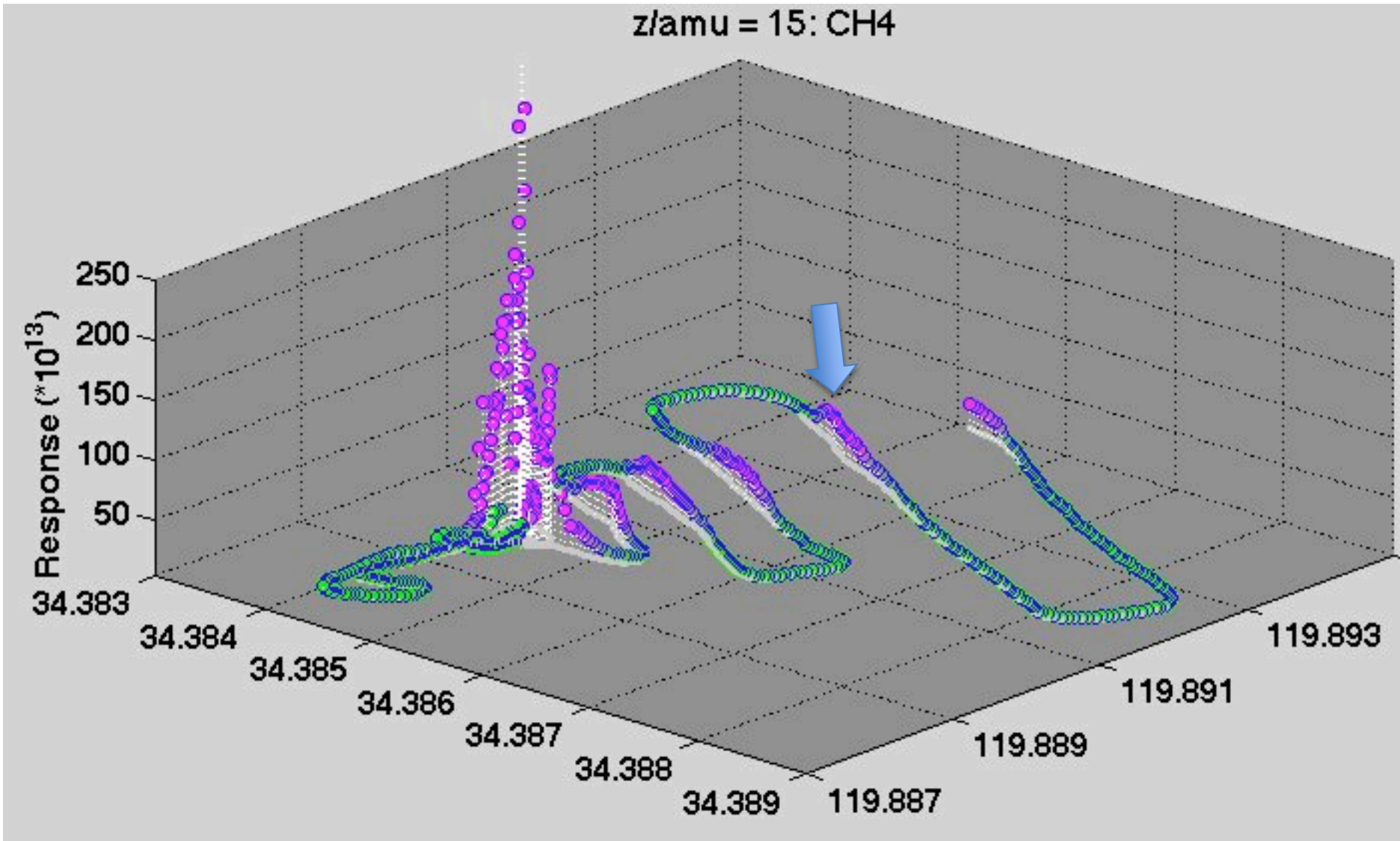

Characteristic main-plume width depends on surface bubble dissolution and upwelling fluid transport. Downcurrent plume affected by dissolution, and vertical and horizontal diffusion. Note increase shown by arrow.

Seep Tent Seep Plume Ethane (near field)

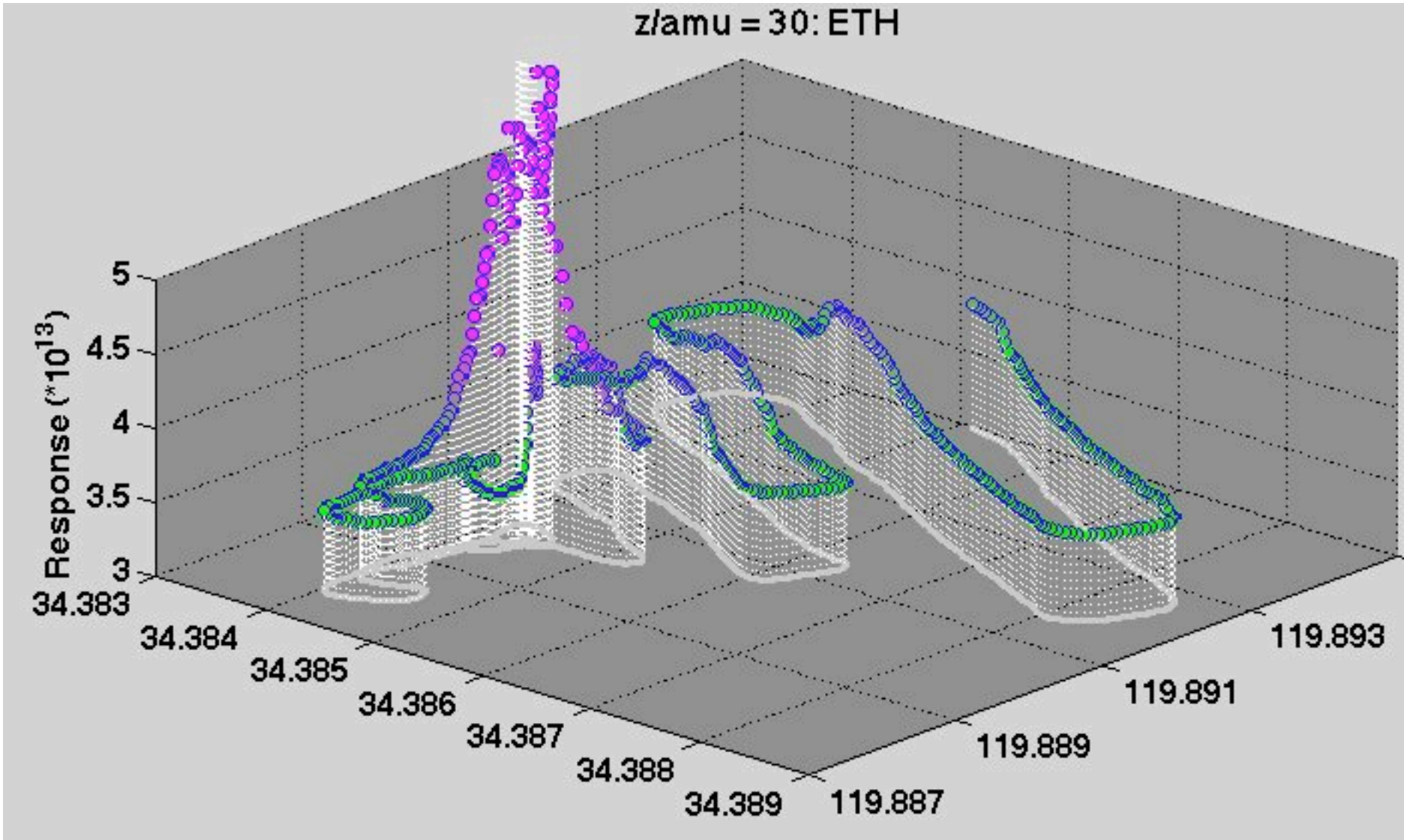

Characteristic main-plume width depends on surface bubble dissolution and upwelling fluid transport. Downcurrent plume clearly visible.

Seep Tent Seep Plume Propane (near field)

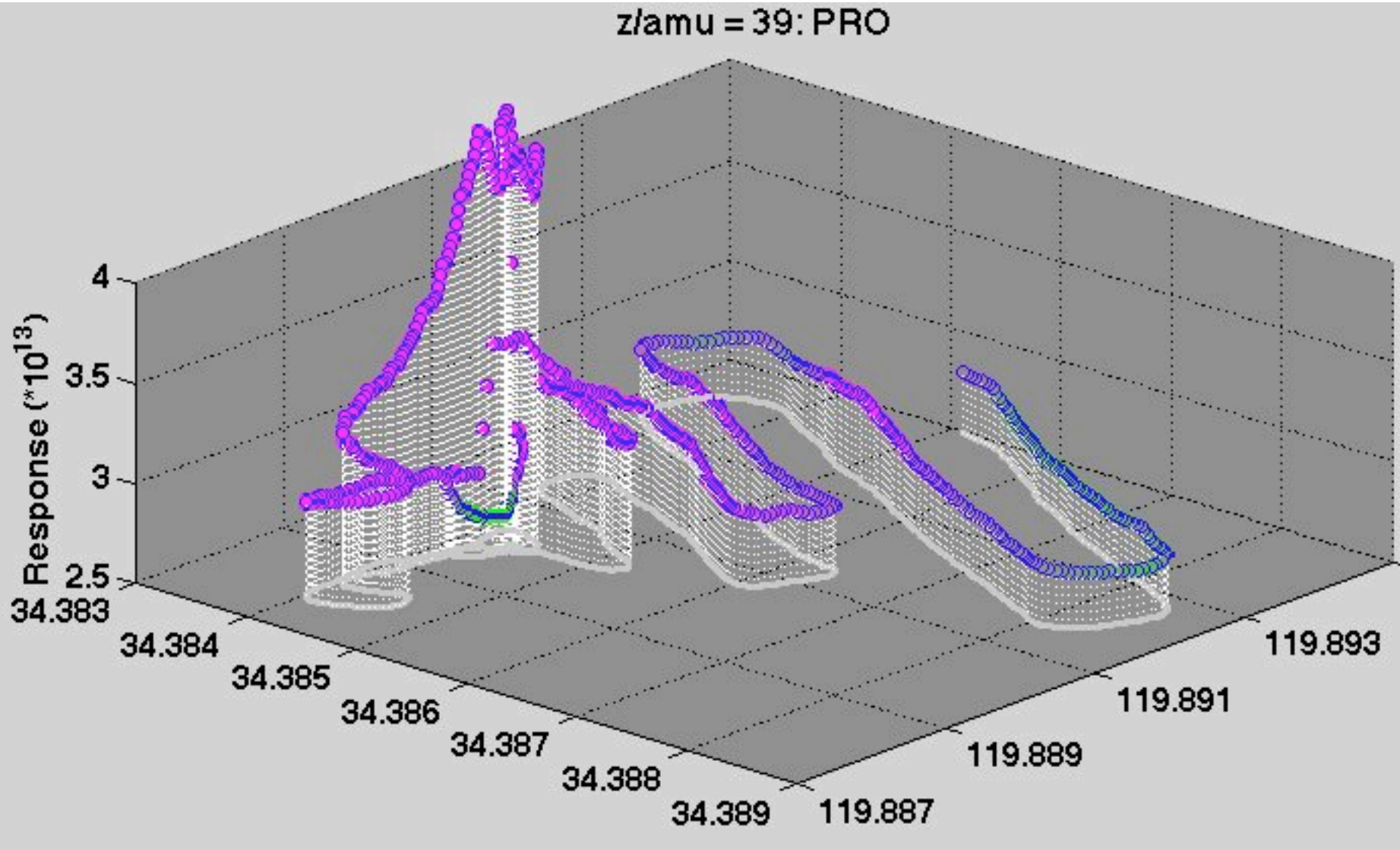

Seep Tent Seep Plume Toluene (near field)

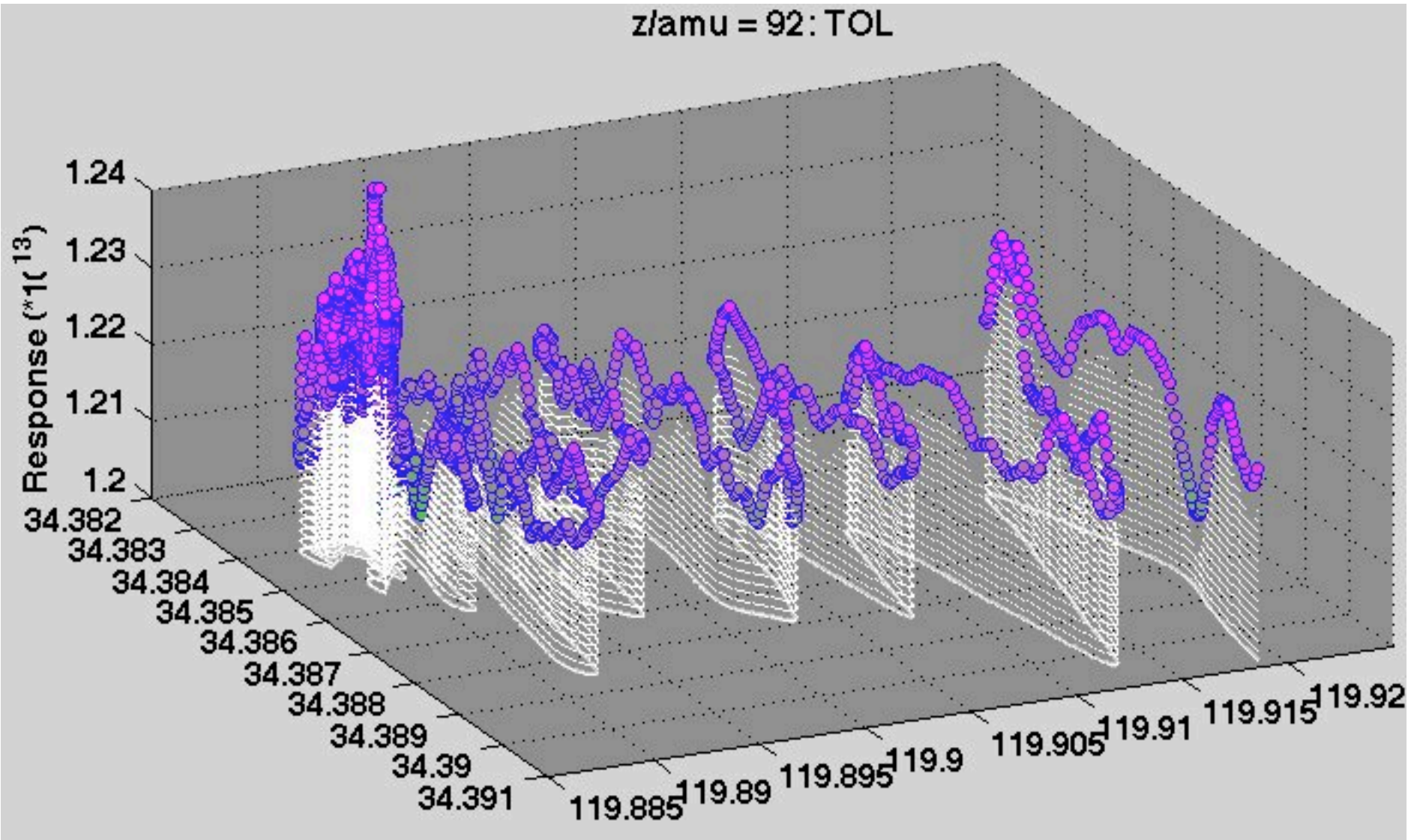

Seep Tent Seep Plume Benzene and Toluene (near field)

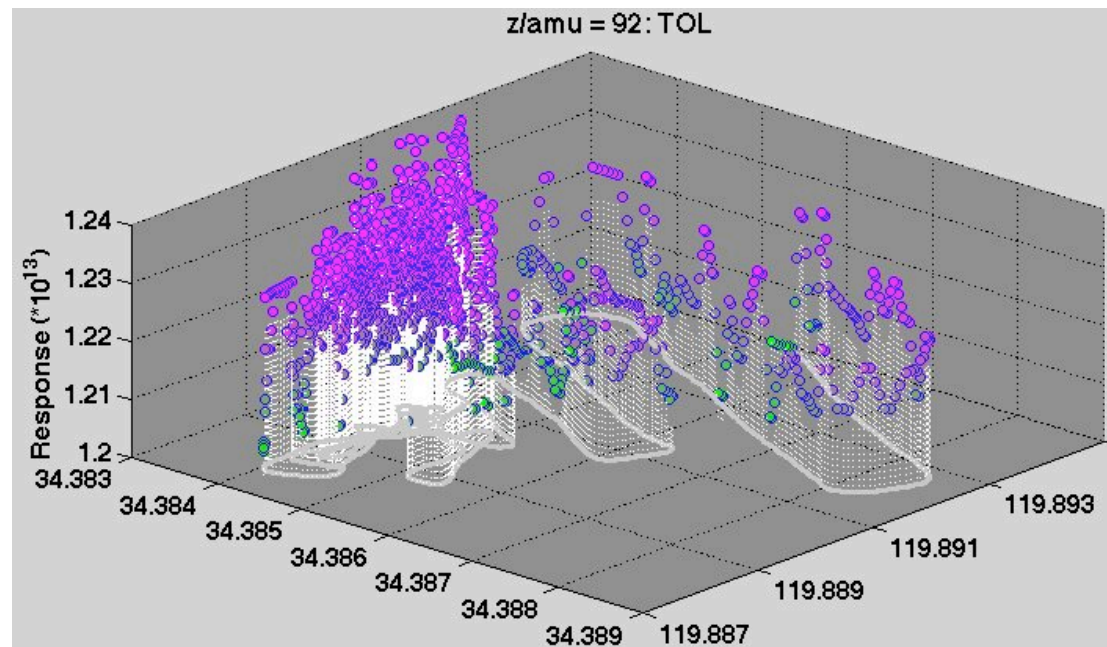
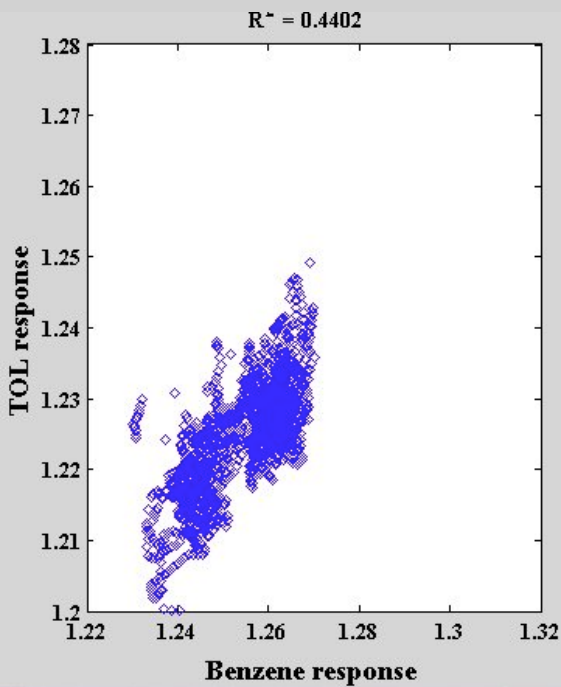
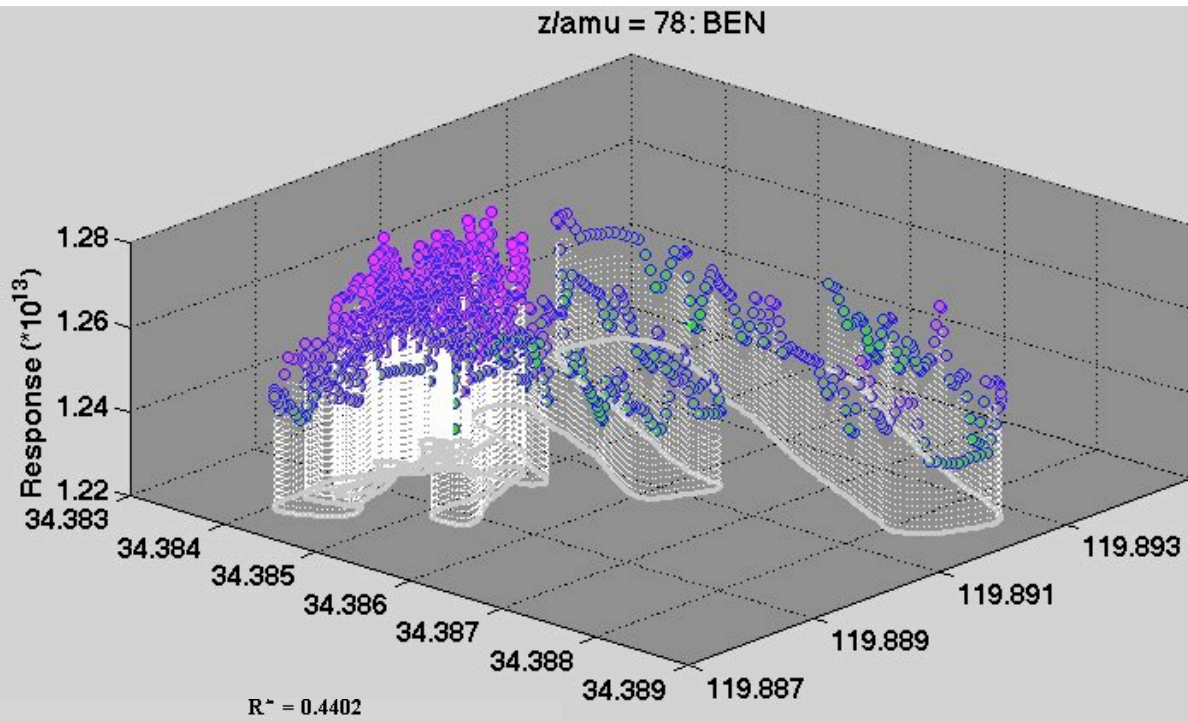

Seep Tent Seep Plume Air Gases (near field)

z/lamu = 40: Ar

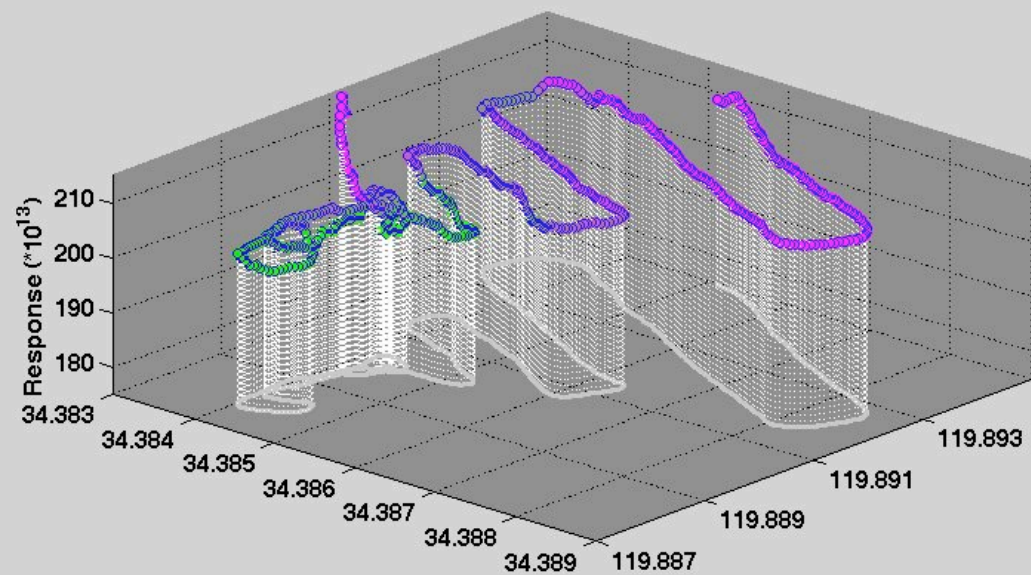

z/lamu = 32: Oxy

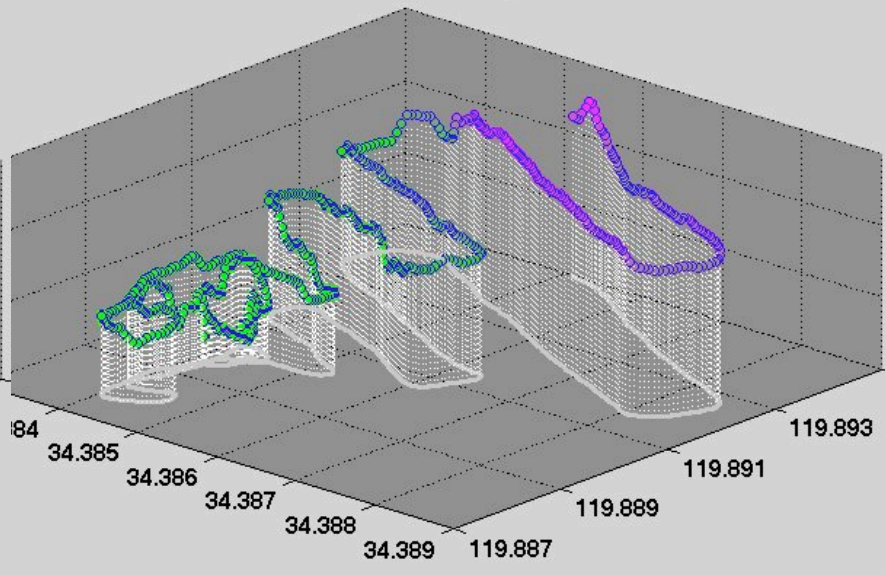

z/lamu = 44: CO2

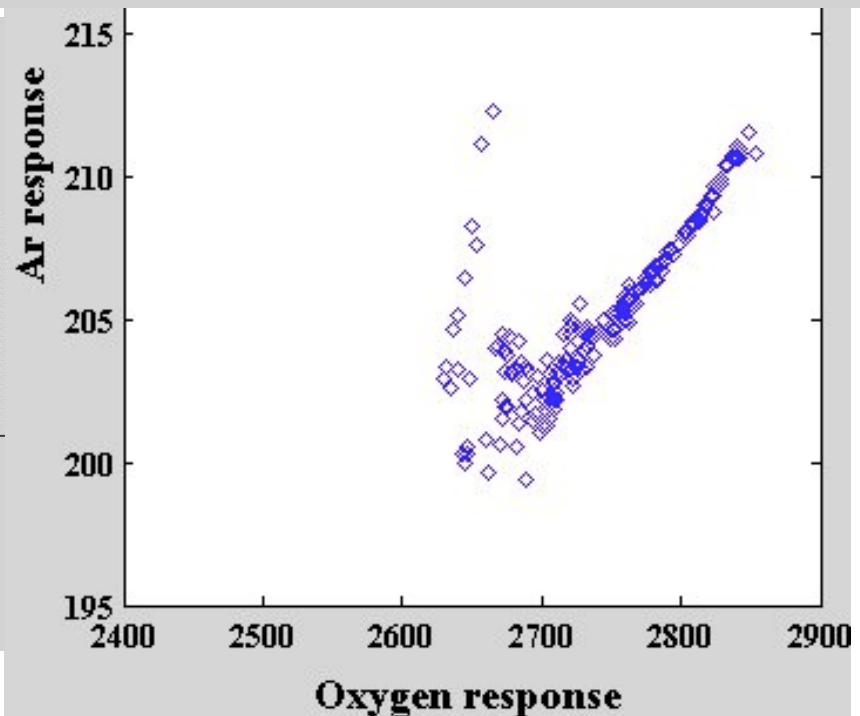
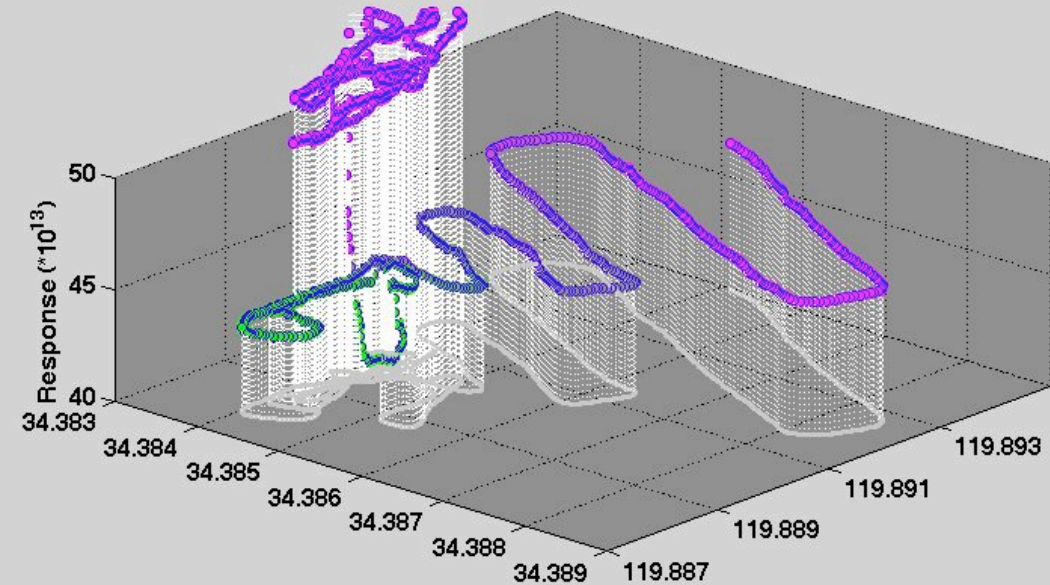

Methane Scatter Plots

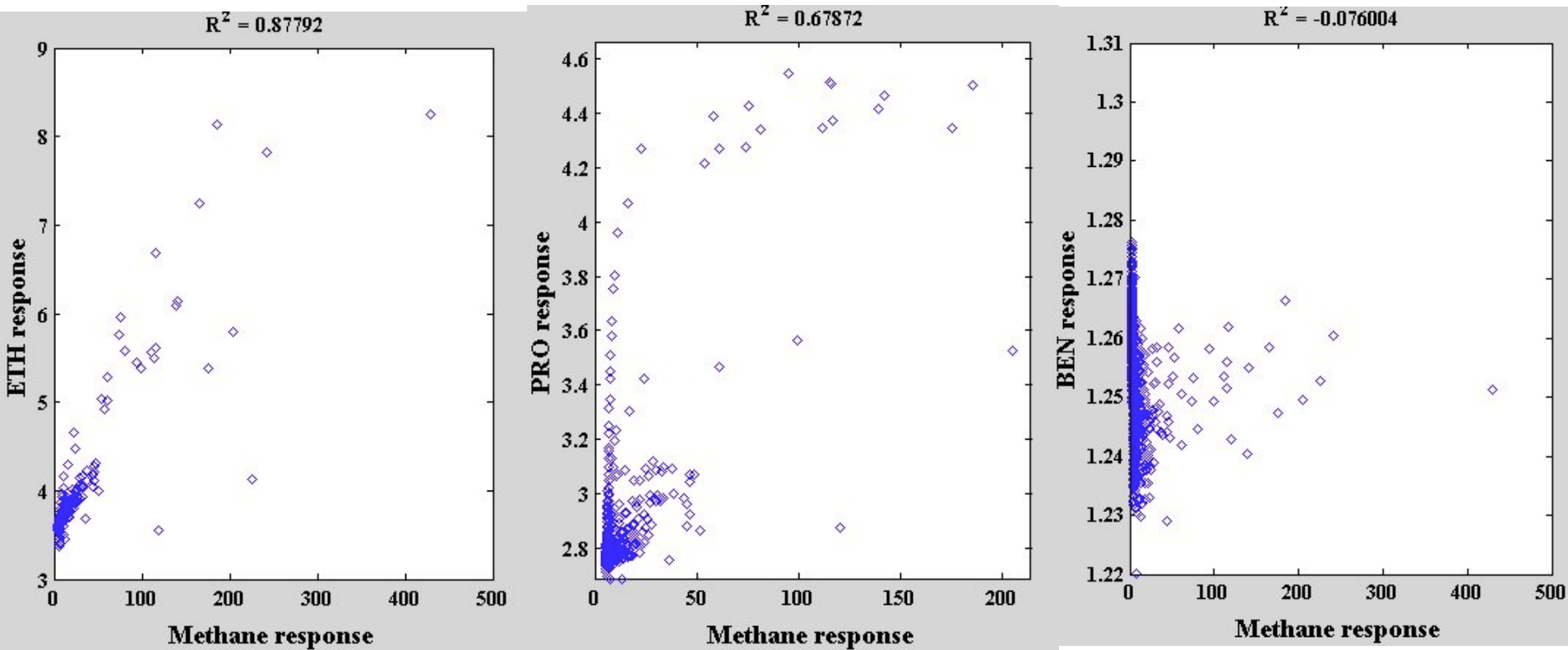

Highest methane values are in the plume. Methane and Ethane well correlated in the main plume and down current plume. Note loss through the sea surface will decrease correlation with time (curve towards lower values)

Propane shows distinct correlations in main plume and down current plume.

Benzene correlated in main plume, not down current (or inverse correlated).

Scatter Butane Plots

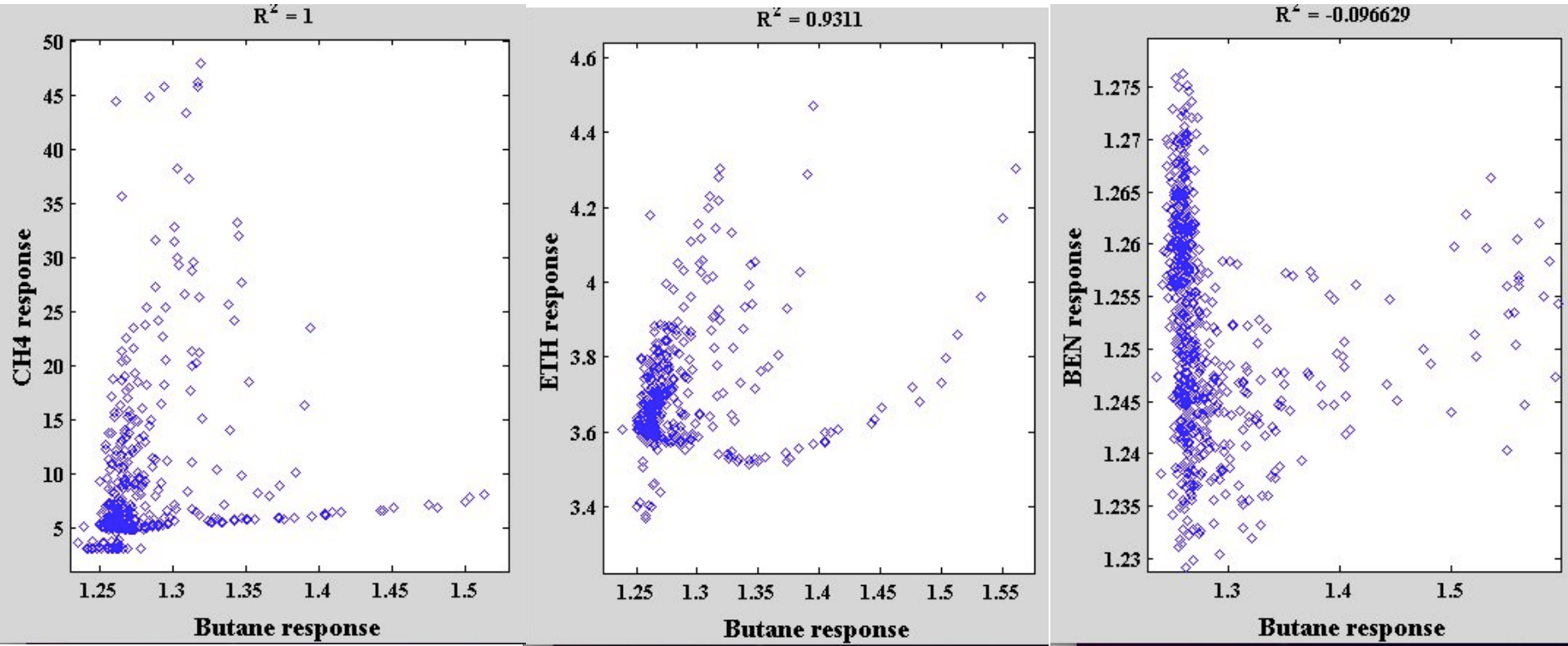

Highest butane values are in the plume. Some correlation with methane in the downcurrent plume.

Ethane shows distinct correlations in main plume and down current plume. Note unique curving for values in the plume.

Benzene inversely and poorly correlated in the down-current plume, not correlated with butane in the plume (suggesting oil dissolution rather than bubble outgassing).

Not shown – toluene and benzene correlated, suggesting toluene data is not purely noise, but requires further analysis

Conclusions

- **In Situ MIMS can be used to study complex bubble plume processes from natural seeps (or blowouts)**
- **In situ MIMS can be used to study plume diffusion processes.**
- **In situ MIMS can be used to study oil dissolution of toxic components into the water column.**
- **In situ MIMS overlaps fluorescent components to cross validate methodologies.**
- **In situ MIMS can map out low air gas zones, where the multiple gases allows validation of transport and diffusion models.**

Conclusions



- **In Situ MIMS can be used to map source emissions from a seep field with fine resolution.**

Conclusions

**Even on a shoe string, important science and technology demonstration and validation can succeed.
(But proper funding greatly improves the results)**

- In situ MIMS can answer a wide range of important oil spill response, oil spill science, as well as provide data on subsurface migration processes.**

Seepage depends on the driving force – i.e., reservoir pressure and hydrostatic pressure and fracture permeability